

CHAPTER 2400**CAPITOL AREA ARCHITECTURAL AND PLANNING BOARD****CAPITOL AREA ZONING AND DESIGN**

- 2400.2000 TITLE.
- 2400.2005 AUTHORITY.
- 2400.2010 PURPOSES.
- 2400.2015 APPLICABILITY AND SCOPE.
- 2400.2020 EXCEPTIONS.
- 2400.2025 SEVERABILITY.
- 2400.2030 RULES OF CONSTRUCTION.
- 2400.2035 OTHER CITY, LOCAL, REGIONAL, STATE, AND FEDERAL LAWS AND REGULATIONS.
- 2400.2040 DEFINITIONS.
- 2400.2100 ZONING DISTRICTS ESTABLISHED.
- 2400.2105 ZONING MAP.
- 2400.2110 BOUNDARIES.
- 2400.2200 GENERAL PROVISIONS.
- 2400.2205 TABLE OF PERMITTED AND CONDITIONAL USES BY DISTRICT.
- 2400.2210 G-1 GOVERNMENT DISTRICT.
- 2400.2215 G-2 GOVERNMENT DISTRICT.
- 2400.2220 RM MODERATE DENSITY RESIDENTIAL DISTRICT.
- 2400.2225 MX MIXED USE DISTRICT.
- 2400.2230 MXD MIXED USE DOWNTOWN DISTRICT.
- 2400.2235 CENTRAL CORRIDOR (CC) OVERLAY DISTRICT.
- 2400.2300 HEIGHT DISTRICTS.
- 2400.2400 FRONTAGE MAP.
- 2400.2405 MIXED AND NONRESIDENTIAL DESIGN STANDARDS FOR FRONTAGE TYPES.
- 2400.2410 RESIDENTIAL DESIGN STANDARDS.
- 2400.2500 EXAMPLES OF BUILDING TYPES.
- 2400.2600 SCOPE.
- 2400.2605 ACCESSORY BUILDINGS.
- 2400.2610 EXTERIOR LIGHTING.
- 2400.2615 ENCROACHMENTS INTO REQUIRED YARDS.
- 2400.2620 CORNER CLEARANCE.
- 2400.2625 STREET AND LANDSCAPE ELEMENTS.
- 2400.2630 LANDSCAPE AND SCREENING STANDARDS.

- 2400.2635 STORM WATER MANAGEMENT STANDARDS.
- 2400.2700 SCOPE.
- 2400.2705 STANDARDS FOR CIVIC AND INSTITUTIONAL USES.
- 2400.2710 STANDARDS FOR RESIDENTIAL USES.
- 2400.2715 STANDARDS FOR CONGREGATE LIVING USES.
- 2400.2720 STANDARDS FOR MIXED COMMERCIAL-RESIDENTIAL USES.
- 2400.2725 STANDARDS FOR PUBLIC SERVICE AND UTILITY USES.
- 2400.2730 STANDARDS FOR COMMERCIAL USES.
- 2400.2735 STANDARDS FOR LIMITED PRODUCTION, PROCESSING, AND STORAGE USES.
- 2400.2740 STANDARDS FOR ACCESSORY USES.
- 2400.2800 GENERAL PARKING REQUIREMENTS.
- 2400.2805 LOCATION OF OFF-STREET PARKING.
- 2400.2810 REDUCTION BELOW REQUIRED MINIMUM PROHIBITED.
- 2400.2815 SHARED OFF-STREET PARKING FACILITIES.
- 2400.2820 SPACES REQUIRED.
- 2400.2825 CONSTRUCTION AND DESIGN OF OFF-STREET PARKING SPACES.
- 2400.2830 BICYCLE PARKING REQUIREMENTS.
- 2400.2835 LOADING SPACE REQUIREMENTS.
- 2400.2900 INTENT.
- 2400.2905 CONSTRUCTION AND MAINTENANCE REQUIREMENTS.
- 2400.2910 SIGN PLACEMENT AND HEIGHT REQUIREMENTS.
- 2400.2915 SIGN DESIGN STANDARDS.
- 2400.2920 EXEMPT SIGNS.
- 2400.2925 PROHIBITED SIGNS.
- 2400.2930 SIGNS ALLOWED IN ALL DISTRICTS.
- 2400.2935 SIGNS PERMITTED BY DISTRICT.
- 2400.2940 NONCONFORMING SIGNS.
- 2400.3000 INTENT.
- 2400.3005 GENERAL PROHIBITION; AUTHORITY TO CONTINUE.
- 2400.3010 REPAIRS AND MAINTENANCE.
- 2400.3015 CHANGE OF TENANCY OR OWNERSHIP.
- 2400.3020 NONCONFORMING LOTS.
- 2400.3100 SCOPE.
- 2400.3105 DUTIES OF BOARD.
- 2400.3110 GENERAL REQUIREMENTS.
- 2400.3115 ST. PAUL PERMIT REQUIREMENTS.
- 2400.3120 SUBDIVISIONS OF PROPERTY.

- 2400.3125 DETERMINATION OF SIMILAR USE.
- 2400.3130 APPLICATION AND REVIEW PROCEDURES.
- 2400.3135 ZONING PERMIT APPLICATION.
- 2400.3140 CERTIFICATE OF DESIGN COMPLIANCE APPLICATION.
- 2400.3145 SIGN PERMIT APPLICATION.
- 2400.3150 SITE PLAN CONTENTS AND REVIEW.
- 2400.3155 CONDITIONAL USES.
- 2400.3160 VARIANCES.
- 2400.3165 REZONINGS AND ZONING AMENDMENTS.
- 2400.3170 APPEALS.
- 2400.3175 ENFORCEMENT AND PENALTIES.
- 2400.3180 FEES.

2400.0001 [Repealed, 34 SR 900]

Published Electronically: *January 15, 2010*

2400.0005 [Repealed, 34 SR 900]

Published Electronically: *January 15, 2010*

2400.0010 Subpart 1. [Renumbered 2400.0011, subpart 1]

Subp. 2. [Renumbered 2400.0011, subp. 2]

Subp. 2a. [Renumbered 2400.0011, subp. 3]

Subp. 3. [Renumbered 2400.0011, subp. 4]

Subp. 3a. [Renumbered 2400.0011, subp. 5]

Subp. 3b. [Renumbered 2400.0011, subp. 6]

Subp. 3c. [Renumbered 2400.0011, subp. 7]

Subp. 3d. [Renumbered 2400.0011, subp. 8]

Subp. 4. [Renumbered 2400.0011, subp. 9]

Subp. 5. [Renumbered 2400.0011, subp. 10]

Subp. 5a. [Renumbered 2400.0011, subp. 11]

Subp. 6. [Renumbered 2400.0011, subp. 12]

Subp. 7. [Renumbered 2400.0011, subp. 13]

Subp. 8. [Renumbered 2400.0011, subp. 14]

Subp. 9. [Renumbered 2400.0011, subp. 15]

- Subp. 10. [Renumbered 2400.0011, subp. 16]
- Subp. 11. [Repealed, 24 SR 940]
- Subp. 12. [Repealed, 24 SR 940]
- Subp. 13. [Renumbered 2400.0011, subp. 17]
- Subp. 13a. [Renumbered 2400.0011, subp. 18]
- Subp. 14. [Renumbered 2400.0011, subp. 19]
- Subp. 14a. [Renumbered 2400.0011, subp. 20]
- Subp. 15. [Repealed, 24 SR 940]
- Subp. 15a. [Renumbered 2400.0011, subp. 22]
- Subp. 16. [Renumbered 2400.0011, subp. 23]
- Subp. 17. [Renumbered 2400.0011, subp. 48]
- Subp. 18. [Renumbered 2400.0011, subp. 55]
- Subp. 19. [Renumbered 2400.0011, subp. 74]
- Subp. 20. [Renumbered 2400.0011, subp. 76]
- Subp. 21. [Renumbered 2400.0011, subp. 25]
- Subp. 22. [Renumbered 2400.0011, subp. 26]
- Subp. 22a. [Renumbered 2400.0011, subp. 27]
- Subp. 23. [Renumbered 2400.0011, subp. 28]
- Subp. 24. [Renumbered 2400.0011, subp. 29]
- Subp. 25. [Renumbered 2400.0011, subp. 31]
- Subp. 26. [Renumbered 2400.0011, subp. 78]
- Subp. 27. [Renumbered 2400.0011, subp. 32]
- Subp. 28. [Renumbered 2400.0011, subp. 33]
- Subp. 29. [Renumbered 2400.0011, subp. 34]
- Subp. 29a. [Renumbered 2400.0011, subp. 35]
- Subp. 30. [Renumbered 2400.0011, subp. 37]
- Subp. 31. [Renumbered 2400.0011, subp. 38]
- Subp. 32. [Renumbered 2400.0011, subp. 40]

- Subp. 33. [Renumbered 2400.0011, subp. 41]
- Subp. 34. [Renumbered 2400.0011, subp. 42]
- Subp. 35. [Renumbered 2400.0011, subp. 21]
- Subp. 36. [Renumbered 2400.0011, subp. 39]
- Subp. 37. [Renumbered 2400.0011, subp. 73]
- Subp. 38. [Renumbered 2400.0011, subp. 83]
- Subp. 39. [Renumbered 2400.0011, subp. 43]
- Subp. 40. [Renumbered 2400.0011, subp. 44]
- Subp. 41. [Repealed, 24 SR 940]
- Subp. 42. [Renumbered 2400.0011, subp. 45]
- Subp. 43. [Renumbered 2400.0011, subp. 46]
- Subp. 44. [Renumbered 2400.0011, subp. 47]
- Subp. 45. [Repealed, 24 SR 940]
- Subp. 46. [Renumbered 2400.0011, subp. 49]
- Subp. 47. [Renumbered 2400.0011, subp. 50]
- Subp. 48. [Renumbered 2400.0011, subp. 51]
- Subp. 48a. [Renumbered 2400.0011, subp. 52]
- Subp. 48b. [Renumbered 2400.0011, subp. 53]
- Subp. 49. [Renumbered 2400.0011, subp. 54]
- Subp. 50. [Renumbered 2400.0011, subp. 56]
- Subp. 50a. [Renumbered 2400.0011, subp. 57]
- Subp. 51. [Renumbered 2400.0011, subp. 58]
- Subp. 52. [Renumbered 2400.0011, subp. 59]
- Subp. 53. [Renumbered 2400.0011, subp. 60]
- Subp. 54. [Renumbered 2400.0011, subp. 61]
- Subp. 55. [Renumbered 2400.0011, subp. 62]
- Subp. 56. [Renumbered 2400.0011, subp. 24]
- Subp. 57. [Renumbered 2400.0011, subp. 30]

- Subp. 58. [Renumbered 2400.0011, subp. 63]
 - Subp. 58a. [Renumbered 2400.0011, subp. 64]
 - Subp. 59. [Renumbered 2400.0011, subp. 65]
 - Subp. 60. [Renumbered 2400.0011, subp. 66]
 - Subp. 61. [Renumbered 2400.0011, subp. 67]
 - Subp. 62. [Renumbered 2400.0011, subp. 36]
 - Subp. 63. [Renumbered 2400.0011, subp. 68]
 - Subp. 63a. [Renumbered 2400.0011, subp. 70]
 - Subp. 63b. [Renumbered 2400.0011, subp. 71]
 - Subp. 64. [Renumbered 2400.0011, subp. 69]
 - Subp. 65. [Renumbered 2400.0011, subp. 72]
 - Subp. 65a. [Renumbered 2400.0011, subp. 75]
 - Subp. 66. [Renumbered 2400.0011, subp. 77]
 - Subp. 67. [Renumbered 2400.0011, subp. 79]
 - Subp. 67a. [Renumbered 2400.0011, subp. 80]
 - Subp. 68. [Renumbered 2400.0011, subp. 81]
 - Subp. 69. [Renumbered 2400.0011, subp. 82]
- Published Electronically:** *January 15, 2010*

2400.0011 [Repealed, 34 SR 900]
Published Electronically: *January 15, 2010*

2400.0020 [Repealed, 24 SR 940]
Published Electronically: *January 15, 2010*

2400.0110 [Renumbered 2400.0001]
Published Electronically: *January 15, 2010*

2400.0120 [Renumbered 2400.0005]
Published Electronically: *January 15, 2010*

2400.0130 [Repealed, 34 SR 900]
Published Electronically: *January 15, 2010*

2400.0140 Subpart 1. [Repealed, 34 SR 900]
Subp. 2. [Repealed, 11 SR 2165]

Subp. 2a. [Repealed, 24 SR 940]

Subp. 2b. [Repealed, 34 SR 900]

Published Electronically: *January 15, 2010*

2400.0150 [Repealed, 34 SR 900]

Published Electronically: *January 15, 2010*

2400.0160 [Repealed, 34 SR 900]

Published Electronically: *January 15, 2010*

2400.0170 [Repealed, 34 SR 900]

Published Electronically: *January 15, 2010*

2400.0180 [Repealed, 34 SR 900]

Published Electronically: *January 15, 2010*

2400.0190 [Repealed, 34 SR 900]

Published Electronically: *January 15, 2010*

2400.0200 [Repealed, 34 SR 900]

Published Electronically: *January 15, 2010*

2400.0210 [Repealed, 34 SR 900]

Published Electronically: *January 15, 2010*

2400.0220 [Repealed, 34 SR 900]

Published Electronically: *January 15, 2010*

2400.0230 [Repealed, 24 SR 940]

Published Electronically: *January 15, 2010*

2400.0235 [Repealed, 34 SR 900]

Published Electronically: *January 15, 2010*

2400.0240 [Repealed, 24 SR 940]

Published Electronically: *January 15, 2010*

2400.0245 [Repealed, 34 SR 900]

Published Electronically: *January 15, 2010*

2400.0250 [Repealed, 24 SR 940]

Published Electronically: *January 15, 2010*

2400.0260 [Repealed, 24 SR 940]

Published Electronically: *January 15, 2010*

2400.0270 [Repealed, 24 SR 940]

Published Electronically: *January 15, 2010*

2400.0280 [Repealed, 24 SR 940]

Published Electronically: *January 15, 2010*

2400.0290 [Repealed, 24 SR 940]

Published Electronically: *January 15, 2010*

2400.0300 [Repealed, 24 SR 940]

Published Electronically: *January 15, 2010*

2400.0310 [Repealed, 24 SR 940]

Published Electronically: *January 15, 2010*

2400.0320 [Renumbered 2400.0235]

Published Electronically: *January 15, 2010*

2400.0330 [Renumbered 2400.0245]

Published Electronically: *January 15, 2010*

2400.0400 [Repealed, 34 SR 900]

Published Electronically: *January 15, 2010*

2400.0410 Subpart 1. [Repealed, 34 SR 900]

Subp. 2. [Repealed, 24 SR 940]

Published Electronically: *January 15, 2010*

2400.0420 Subpart 1. [Repealed, 34 SR 900]

Subp. 2. [Repealed, 24 SR 940]

Subp. 2a. [Repealed, 34 SR 900]

Published Electronically: *January 15, 2010*

2400.0450 [Repealed, 34 SR 900]

Published Electronically: *January 15, 2010*

2400.0460 [Repealed, 34 SR 900]

Published Electronically: *January 15, 2010*

2400.0470 [Repealed, 34 SR 900]

Published Electronically: *January 15, 2010*

2400.0480 [Repealed, 34 SR 900]

Published Electronically: *January 15, 2010*

2400.0490 [Repealed, 34 SR 900]

Published Electronically: *January 15, 2010*

2400.0500 [Repealed, 34 SR 900]

Published Electronically: *January 15, 2010*

2400.0510 [Repealed, 34 SR 900]

Published Electronically: *January 15, 2010*

2400.0520 [Repealed, 34 SR 900]

Published Electronically: *January 15, 2010*

2400.0530 [Repealed, 34 SR 900]

Published Electronically: *January 15, 2010*

2400.0540 Subpart 1. [Repealed, 34 SR 900]

Subp. 2. [Repealed, 24 SR 940]

Published Electronically: *January 15, 2010*

2400.0600 [Repealed, 34 SR 900]

Published Electronically: *January 15, 2010*

2400.0610 [Repealed, 34 SR 900]

Published Electronically: *January 15, 2010*

2400.0620 [Repealed, 34 SR 900]

Published Electronically: *January 15, 2010*

2400.0650 [Repealed, 34 SR 900]

Published Electronically: *January 15, 2010*

2400.0660 [Repealed, 34 SR 900]

Published Electronically: *January 15, 2010*

2400.0670 [Repealed, 34 SR 900]

Published Electronically: *January 15, 2010*

2400.0680 [Repealed, 34 SR 900]

Published Electronically: *January 15, 2010*

2400.0700 [Repealed, 34 SR 900]

Published Electronically: *January 15, 2010*

2400.0710 [Repealed, 34 SR 900]

Published Electronically: *January 15, 2010*

2400.0720 [Repealed, 34 SR 900]

Published Electronically: *January 15, 2010*

2400.0730 [Repealed, 34 SR 900]

Published Electronically: *January 15, 2010*

2400.0740 Subpart 1. [Repealed, 34 SR 900]

Subp. 2. [Repealed, 34 SR 900]

Subp. 3. [Repealed, 24 SR 940]

Subp. 4. [Repealed, 34 SR 900]

Published Electronically: *January 15, 2010*

2400.0750 [Repealed, 34 SR 900]

Published Electronically: *January 15, 2010*

2400.0800 [Repealed, 34 SR 900]

Published Electronically: *January 15, 2010*

2400.0810 [Repealed, 34 SR 900]

Published Electronically: *January 15, 2010*

2400.0820 [Repealed, 34 SR 900]

Published Electronically: *January 15, 2010*

2400.0830 [Repealed, 34 SR 900]

Published Electronically: *January 15, 2010*

2400.0850 [Repealed, 34 SR 900]

Published Electronically: *January 15, 2010*

2400.0860 [Repealed, 34 SR 900]

Published Electronically: *January 15, 2010*

2400.0870 [Repealed, 34 SR 900]

Published Electronically: *January 15, 2010*

2400.0880 [Repealed, 34 SR 900]

Published Electronically: *January 15, 2010*

2400.0890 [Repealed, 34 SR 900]

Published Electronically: *January 15, 2010*

2400.0900 [Repealed, 34 SR 900]

Published Electronically: *January 15, 2010*

2400.0910 [Repealed, 34 SR 900]

Published Electronically: *January 15, 2010*

2400.0920 [Repealed, 34 SR 900]

Published Electronically: *January 15, 2010*

2400.0930 [Repealed, 34 SR 900]

Published Electronically: *January 15, 2010*

2400.0950 [Repealed, 34 SR 900]

Published Electronically: *January 15, 2010*

2400.0960 [Repealed, 34 SR 900]

Published Electronically: *January 15, 2010*

- 2400.0970** [Repealed, 34 SR 900]
Published Electronically: *January 15, 2010*
- 2400.0980** [Repealed, 34 SR 900]
Published Electronically: *January 15, 2010*
- 2400.0990** [Repealed, 34 SR 900]
Published Electronically: *January 15, 2010*
- 2400.1000** [Repealed, 34 SR 900]
Published Electronically: *January 15, 2010*
- 2400.1010** [Repealed, 34 SR 900]
Published Electronically: *January 15, 2010*
- 2400.1020** [Repealed, 34 SR 900]
Published Electronically: *January 15, 2010*
- 2400.1050** [Repealed, 34 SR 900]
Published Electronically: *January 15, 2010*
- 2400.1060** [Repealed, 34 SR 900]
Published Electronically: *January 15, 2010*
- 2400.1070** [Repealed, 34 SR 900]
Published Electronically: *January 15, 2010*
- 2400.1080** [Repealed, 24 SR 940]
Published Electronically: *January 15, 2010*
- 2400.1090** [Repealed, 24 SR 940]
Published Electronically: *January 15, 2010*
- 2400.1100** [Repealed, 34 SR 900]
Published Electronically: *January 15, 2010*
- 2400.1110** [Repealed, 34 SR 900]
Published Electronically: *January 15, 2010*
- 2400.1150** Subpart 1. [Repealed, 34 SR 900]
Subp. 2. [Repealed, 24 SR 940]
Subp. 2a. [Repealed, 34 SR 900]
Published Electronically: *January 15, 2010*
- 2400.1160** [Repealed, 34 SR 900]
Published Electronically: *January 15, 2010*
- 2400.1170** [Repealed, 34 SR 900]
Published Electronically: *January 15, 2010*

- 2400.1180** [Repealed, 34 SR 900]
Published Electronically: *January 15, 2010*
- 2400.1190** [Repealed, 34 SR 900]
Published Electronically: *January 15, 2010*
- 2400.1200** [Repealed, 34 SR 900]
Published Electronically: *January 15, 2010*
- 2400.1210** [Repealed, 34 SR 900]
Published Electronically: *January 15, 2010*
- 2400.1220** [Repealed, 34 SR 900]
Published Electronically: *January 15, 2010*
- 2400.1230** [Repealed, 34 SR 900]
Published Electronically: *January 15, 2010*
- 2400.1240** [Repealed, 34 SR 900]
Published Electronically: *January 15, 2010*
- 2400.1250** [Repealed, 34 SR 900]
Published Electronically: *January 15, 2010*
- 2400.1300** [Repealed, 34 SR 900]
Published Electronically: *January 15, 2010*
- 2400.1310** [Repealed, 34 SR 900]
Published Electronically: *January 15, 2010*
- 2400.1320** [Repealed, 34 SR 900]
Published Electronically: *January 15, 2010*
- 2400.1330** [Repealed, 34 SR 900]
Published Electronically: *January 15, 2010*
- 2400.1340** [Repealed, 34 SR 900]
Published Electronically: *January 15, 2010*
- 2400.1350** [Repealed, 34 SR 900]
Published Electronically: *January 15, 2010*
- 2400.1360** [Repealed, 34 SR 900]
Published Electronically: *January 15, 2010*
- 2400.1370** [Repealed, 34 SR 900]
Published Electronically: *January 15, 2010*
- 2400.1380** [Repealed, 34 SR 900]
Published Electronically: *January 15, 2010*

2400.1390 [Repealed, 24 SR 940]
Published Electronically: *January 15, 2010*

2400.1400 [Repealed, 34 SR 900]
Published Electronically: *January 15, 2010*

2400.1410 [Repealed, 24 SR 940]
Published Electronically: *January 15, 2010*

2400.1420 [Repealed, 34 SR 900]
Published Electronically: *January 15, 2010*

2400.1430 [Repealed, 34 SR 900]
Published Electronically: *January 15, 2010*

2400.1440 [Repealed, 34 SR 900]
Published Electronically: *January 15, 2010*

2400.1460 [Repealed, 34 SR 900]
Published Electronically: *January 15, 2010*

2400.1470 [Repealed, 34 SR 900]
Published Electronically: *January 15, 2010*

2400.1500 [Repealed, 34 SR 900]
Published Electronically: *January 15, 2010*

2400.1510 [Repealed, 34 SR 900]
Published Electronically: *January 15, 2010*

2400.1520 [Repealed, 34 SR 900]
Published Electronically: *January 15, 2010*

2400.1530 [Repealed, 34 SR 900]
Published Electronically: *January 15, 2010*

2400.2000 TITLE.

This chapter shall be known and may be cited as the "Capitol Area Zoning and Design Rules."

Statutory Authority: *MS s 15B.06*

History: *34 SR 900*

Published Electronically: *January 15, 2010*

2400.2005 AUTHORITY.

This chapter is enacted pursuant to the authority granted to the Capitol Area Architectural and Planning Board by Minnesota Statutes, sections 15B.01 to 15B.31.

Statutory Authority: *MS s 15B.06*

History: 34 SR 900

Published Electronically: January 15, 2010

2400.2010 PURPOSES.

This chapter is adopted by the Capitol Area Architectural and Planning Board to further the statutory purposes of the board under Minnesota Statutes, section 15B.01, to:

A. preserve and enhance the dignity, beauty, and architectural integrity of the Capitol, the buildings immediately adjacent to it, the Capitol grounds, and the Capitol area;

B. protect, enhance, and increase the open spaces within the Capitol area when deemed necessary and desirable for the improvement of the public enjoyment;

C. develop proper approaches to the Capitol area for pedestrian movement, the highway system, and mass transit system so that the area achieves its maximum importance and accessibility; and

D. establish a flexible framework for growth of the Capitol buildings which will be in keeping with the spirit of the original design.

Statutory Authority: MS s 15B.06

History: 34 SR 900

Published Electronically: January 15, 2010

2400.2015 APPLICABILITY AND SCOPE.

No Capitol area building or structure shall be erected, converted, enlarged, reconstructed, or altered, and no Capitol area building, structure, or land shall be used for any purpose that is not in conformity with this chapter.

If the application of any portion of this chapter to a particular property is determined to be invalid or unconstitutional by a court of competent jurisdiction, the determination shall not affect the application of the provision to any other property.

Statutory Authority: MS s 15B.06

History: 34 SR 900

Published Electronically: January 15, 2010

2400.2020 EXCEPTIONS.

Subpart 1. **Essential services.** Essential services are permitted as authorized and regulated by law and rule, and are exempt from the application of this chapter.

Subp. 2. **Voting places.** This chapter shall not be construed to interfere with the temporary use of any property as a voting place in connection with a public election.

Statutory Authority: MS s 15B.06

History: 34 SR 900

Published Electronically: January 15, 2010

2400.2025 SEVERABILITY.

If any portion of this chapter is determined to be invalid or unconstitutional by a court of competent jurisdiction, that portion shall be deemed severed and the determination shall not affect the validity of the remainder of the chapter.

Statutory Authority: MS s 15B.06

History: 34 SR 900

Published Electronically: January 15, 2010

2400.2030 RULES OF CONSTRUCTION.

In case of any difference of meaning or implication between the text of this chapter and any caption or illustration, the text shall control. Illustrations in this chapter are provided for purposes of describing, clarifying, or providing examples; the illustrations are not to scale and do not replace, limit, or expand the meaning of the text.

Statutory Authority: MS s 15B.06

History: 34 SR 900

Published Electronically: January 15, 2010

2400.2035 OTHER CITY, LOCAL, REGIONAL, STATE, AND FEDERAL LAWS AND REGULATIONS.

Subpart 1. **Conflicting laws and regulations.** This chapter, established by the state of Minnesota, shall take precedence over the laws and regulations of city, local, and regional authorities, except as otherwise specifically provided.

Subp. 2. **Reference to other laws and regulations.** In addition to the requirements of this chapter, all uses and development shall comply with all other applicable city, local, regional, state, and federal laws and regulations. All references in this chapter to other city, local, regional, state, or federal laws and regulations are for informational purposes only, and do not constitute a complete list of the laws and regulations. These references do not imply any responsibility by the board for enforcement of other city, local, regional, state, or federal laws and regulations.

Subp. 3. **Current versions and citations.** All references to other city, local, regional, state, or federal laws and regulations in this chapter are intended to refer to the most current version and citation for those laws and regulations. If the references are no longer valid due to repeal or renumbering, the new laws and regulations intended to replace those cited shall apply.

Statutory Authority: MS s 15B.06

History: 34 SR 900

Published Electronically: January 15, 2010

2400.2040 DEFINITIONS.

Subpart 1. **Scope.** For the purposes of this chapter, the terms defined in this part have the meanings given them.

Subp. 2. **Abut.** "Abut" means having a common boundary or relationship at either a common property line, street, or alley.

Subp. 3. **Accessory use.** "Accessory use" means a use that is incidental to, customarily found in connection with, and, except in the case of off-street parking spaces and loading, located on the same zoning lot as the principal use to which it is related. Generally, an accessory use occupies less square footage than the principal use.

Subp. 4. **Adjacent.** "Adjacent" means located nearby, with or without contact.

Subp. 5. **Adjoin.** "Adjoin" means having a common boundary or relationship at a common property line.

Subp. 6. **Adult uses.** "Adult uses" means those uses that are not open to the general public but exclude members of the public by means of age and in which there is an emphasis on the presentation, display, depiction, or description of specific sexual activities or specific anatomical areas. Adult uses include adult bookstores, adult motion or minimotion picture theaters, adult massage parlors, adult saunas, adult health clubs, cabarets, and other similar uses.

Subp. 7. **Alley.** "Alley" means a dedicated public way not more than 30 feet wide affording a secondary means of access to abutting property and not intended for general traffic circulation.

Subp. 8. **Antenna.** "Antenna" means any system of wires, poles, rods, towers, reflecting disks, dishes, or similar devices used for the transmission or reception of communication external to or attached to the exterior of any building, or freestanding elsewhere on the property.

Subp. 9. **Auto body shop or repair center.** "Auto body shop" or "repair center" means a shop in the business of making repairs to any motor vehicle.

Subp. 10. **Auto convenience market.** "Auto convenience market" means a place where gas, oil, lubricants, or minor accessories are sold directly to the public on the premises in combination with everyday items normally found in a convenience store or supermarket.

Subp. 11. **Automobile service station.** "Automobile service station" means an establishment where automotive fuel, tires, batteries, accessories, and parts for passenger automobiles are sold or installed.

Subp. 12. **Basement.** "Basement" means that portion of a building, partly or wholly below grade, so located that the vertical distance from the average grade to the floor is greater than the vertical distance from the average grade to the ceiling.

Basement vs. Story

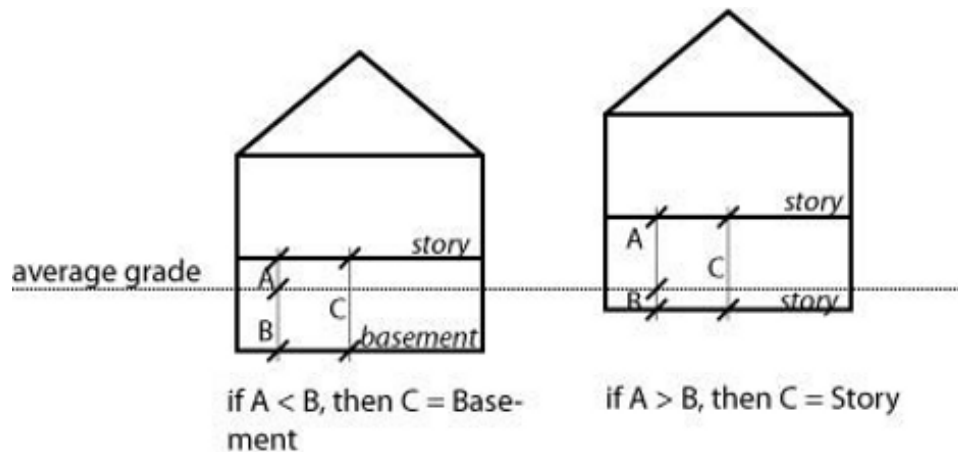

Subp. 13. **Bed and breakfast residence.** "Bed and breakfast residence" means a dwelling in which four or fewer guest rooms are rented within the principal structure on a nightly basis for less than one week and where at least one meal per day is provided in connection with the sleeping accommodations. The operator of the residence lives on the premises or in an adjacent premise.

Subp. 14. **Block.** "Block" means the property abutting one side of a street and lying between the two nearest intersecting streets, crossing or terminating; between the nearest such street and railroad right-of-way, unsubdivided acreage, lake, river, or live stream; or between any of the foregoing and any other barrier to the continuity of development.

Subp. 15. **Board.** "Board" means the Capitol Area Architectural and Planning Board as created by Minnesota Statutes, section 15B.03, subdivision 1.

Subp. 16. **Boarding or rooming house.** "Boarding or rooming house" means a building designed for or used as a one-family or two-family dwelling and containing guest rooms where lodging, with or without meals, is provided for compensation on a daily, weekly, or monthly basis.

Subp. 17. **Building.** "Building" includes structure and any part thereof.

Subp. 18. **Building height.** "Building height" means the distance measured from the established grade, to the highest point of the parapet coping for flat roofs, to the highest point of mansard roofs, to the average height between eaves and the highest ridge for pitched or hipped roofs, or to the highest point of any equipment mounted on the building, with the exception of antennas, towers, and flagpoles.

Measurement of Height, Pitched, Hipped, and Mansard Roofs

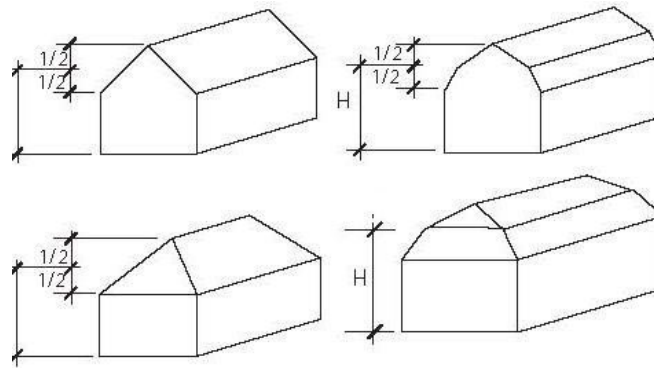

Subp. 19. **Capitol area.** "Capitol area" has the meaning given in Minnesota Statutes, section 15B.02.

Subp. 20. **Comprehensive plan.** "Comprehensive plan" means the plan adopted by the board pursuant to Minnesota Statutes, section 15B.05, including any unit or part of the plan and any amendment to all or parts of the plan.

Subp. 21. **Conditional use.** "Conditional use" means a land use or development as defined by this chapter that would not be appropriate generally but may be allowed with appropriate restrictions as provided by official controls upon a finding that:

- A. certain conditions as detailed in this chapter exist; and
- B. the use or development conforms to the comprehensive land use plan of the board, and is compatible with the existing neighborhood.

Subp. 22. **Contiguous.** "Contiguous" means abutting.

Subp. 23. **Corner lot.** "Corner lot" means a lot abutting two intersecting streets where the interior angle of two adjacent sides at the intersection of two streets is less than 135 degrees. A lot abutting upon a curved street or streets shall be considered a corner lot for the purposes of this chapter if the arc is of less radius than 150 feet and the tangents to the curve, at the two points where the lot lines meet the curve or the straight street line, extended, form an interior angle of less than 135 degrees.

Corner Lots, Interior Lots, and Through Lots

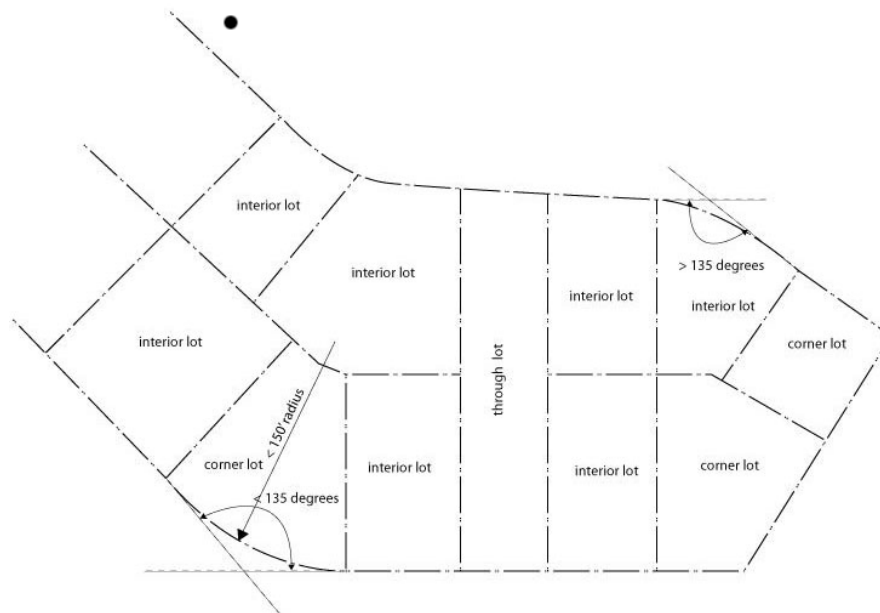

Subp. 24. **Day care.** "Day care" means the care of one or more children on a regular basis, for periods of less than 24 hours per day. Day care includes family day care, group family day care, and group day care as defined in items A to C.

A. "Family day care" means a day care program providing care for not more than ten children at one time that is licensed by the county as a family day care home. The licensed capacity must include all children of any caregiver when the children are present in the residence.

B. "Group family day care" means a day care program providing care for no more than 14 children at any one time, of which no more than ten are under school age, that is licensed by the county as a group family day care home. The licensed capacity must include all children of any caregiver when the children are present in the residence.

C. "Group day care" means a day care program providing care for more than six children at one time that is licensed by the state or the city as a group day care center. Group day care includes programs for children known as nursery schools, day nurseries, child care centers, play groups, day care centers for school-age children, after-school programs, infant day care centers, cooperative day care centers, and Head Start programs.

Subp. 25. **Development.** "Development" means the construction of a new building or other structure on a zoning lot, the relocation of an existing building on another zoning lot, or the use of open land for a new use.

Subp. 26. **Drive-in restaurant.** "Drive-in restaurant" means a business establishment whose principal business is the selling of food, frozen desserts, or beverages to the customer in a ready-to-consume state, in individual servings, and where the customer is served and consumes these foods, frozen desserts, or beverages in an automobile parked on the premises.

Subp. 27. **Dwelling unit.** "Dwelling unit" means a building or portion of a building, designed for occupancy by one family for residential purposes and having cooking facilities.

Subp. 28. **Elevation.** "Elevation" means the height of a point expressed in feet above mean sea level, sea level datum of 1929 adjusted.

Subp. 29. **Emergency housing facilities.** "Emergency housing facilities" means a building where homeless or abused persons receive overnight shelter on a time-limited basis but are not expected to remain on a 24-hour-per-day basis.

Subp. 30. **Essential services.** "Essential services" means the erection, construction, alteration, or maintenance by public utilities or municipal departments of underground, surface, or overhead gas, electrical, steam, fuel, or water transmission or distribution system, collection, communication, supply, or disposal system, including towers, poles, wires, mains, drains, sewers, pipes, conduits, cables, fire alarm and police call boxes, traffic signals, hydrants, and similar equipment in connection to those services, but not including buildings, which are necessary for the furnishing of adequate service by the utilities or municipal departments for the general health, safety, or welfare.

Subp. 31. **Family.** "Family" means one or more persons, but not more than four if unrelated, living as a single housekeeping unit in a dwelling.

Subp. 32. **Fast food restaurant.** "Fast food restaurant" means a business establishment whose principal business is the selling of standardized, preprepared, quick-order, and packaged foods in a ready-to-consume state, packaged in nonreturnable, disposable containers or wrapping, where the customer may consume these foods while seated at fixed tables or counters located within a building or in a vehicle after being served at a drive-through window. All restaurants with drive-through windows are considered fast food restaurants.

Subp. 33. **Floor area.** "Floor area" means the sum of the horizontal areas of all floors of a building measured from the exterior faces of the exterior walls or from the centerline of walls separating two buildings. The floor area is exclusive of areas of unfinished basements, unfinished attics, or attached garages and structured parking.

Subp. 34. **Floor area ratio or FAR.** "Floor area ratio" or "FAR" means the total floor area of all buildings or structures on a zoning lot divided by the area of that lot.

Subp. 35. **Front setback line.** "Front setback line" means a line parallel to the front lot line that establishes the minimum front yard depth of a zoning lot.

Subp. 36. **Grade.** "Grade" means the elevation established for regulating the number of stories and the height of buildings. For buildings having a wall or walls on or within 15 feet of a street line, grade is curb level, or its equivalent, opposite the wall or walls. When a building has frontage on more than one street, the lowest curb level applies. For buildings having all walls more than 15 feet from a street line, grade is the mean level of the finished surface of the ground adjacent to the exterior walls of the buildings. The existing grade of the property may not be raised around a new building or foundation in order to comply with the height requirements of this chapter.

Grade Measurements

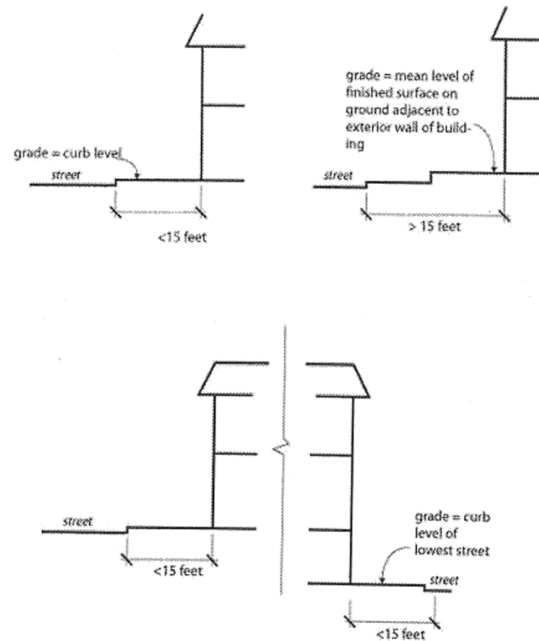

Subp. 37. **Gross leasable floor area.** "Gross leasable floor area" means the total floor area of a building or structure designed for the tenants' occupancy and exclusive use, including basements, mezzanines, and upper floors, expressed in square feet and measured from the outside face of the exterior walls and from the centerline of common walls or joint partitions. Gross leasable floor area includes sales and integral stock areas, but excludes stairwells, elevator shafts, mechanical rooms, space related to the operation and maintenance of the building, and lobbies and bathrooms located for common or public use rather than for tenant or internal use.

Subp. 38. **Home occupation.** "Home occupation" means an occupation or business carried on in a dwelling unit by the resident, provided the use is limited in extent, incidental and secondary to the use of the dwelling unit for residential purposes, and does not change the character of the dwelling unit.

Subp. 39. **Housing for the elderly.** "Housing for the elderly" means a multiple-family structure controlled by either a public body, institutional body, or nonprofit corporation, 80 percent of whose occupants are 65 years of age or over.

Subp. 40. **Impervious coverage.** "Impervious coverage" means the total area of all buildings, measured at grade; all accessory structures, including pools and patios; and all paved areas as a percentage of the total area of the lot, with the following exceptions: sidewalks or paved paths no wider than three feet, pervious pavement, and green roofs.

Subp. 41. **Interior lot.** "Interior lot" means any lot other than a corner lot.

Subp. 42. **Live-work unit.** "Live-work unit" means a dwelling unit in combination with a shop, office, studio, or other work space within the same unit, where the resident occupant lives and works.

Subp. 43. **Loading space.** "Loading space" means an off-street space on the same lot with a building or group of buildings, for the temporary parking of a commercial vehicle while loading and unloading merchandise or materials.

Subp. 44. **Lot.** "Lot" means a parcel of land occupied and used, or intended to be occupied and used, by a building or a group of buildings, together with yards and open spaces as are required under this chapter, whether or not specifically designed as such on public records.

Subp. 45. **Lot area.** "Lot area" means the total horizontal area within the lot lines of the lot.

Subp. 46. **Lot depth.** "Lot depth" means the median horizontal distance between the front and rear lot lines.

Subp. 47. **Lot frontage.** "Lot frontage" means the width of a lot measured along the line separating the lot from any street, except that, for a lot that abuts on more than one street, the lot frontage is the sum of the width of the lot measured along the line separating the lot from the street yielding the least width plus one-half of the widths of the lot measured along the lines separating the lot from the other streets.

Subp. 48. **Lot of record.** "Lot of record" means a parcel of land, the dimensions of which are shown on a document or map on file with the county recorder or registrar of titles or in common use by state, municipal, or county officials, and that actually exists as shown.

Subp. 49. **Lot width.** "Lot width" means the horizontal distance between the side lot lines, measured at the two points where the building line or setback line intersects the side lot lines.

Lot Width is Measured at Building Line

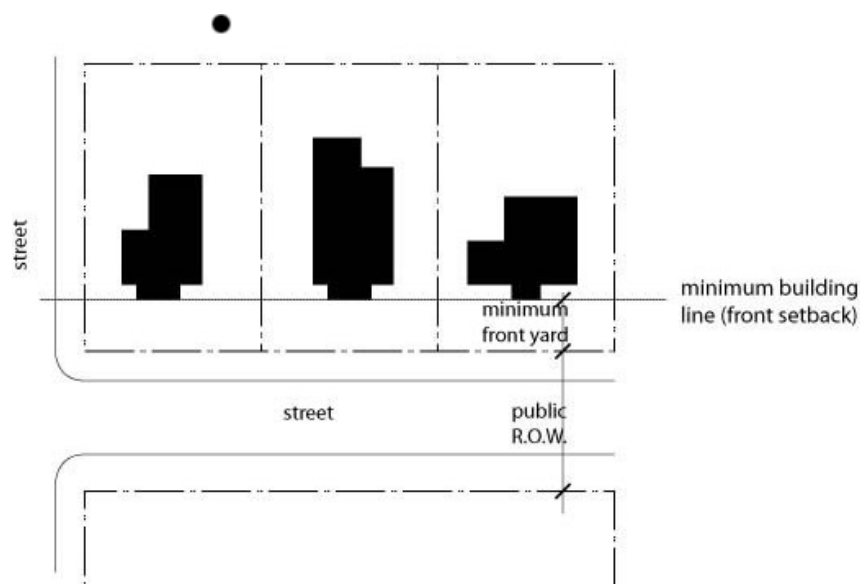

Subp. 50. **Major thoroughfare.** "Major thoroughfare" means an arterial street designated as a major artery or freeway in the comprehensive plan.

Subp. 51. **Multiple-family dwelling.** "Multiple-family dwelling" means a building designed exclusively for occupancy by three or more families living independently of each other.

Subp. 52. **Nonconforming building or sign.** "Nonconforming building or sign" means a building or portion of a building or a sign that lawfully existed prior to the effective date of the applicable rule or amendment, whichever is later, and that, on or after the effective date of the applicable rule or amendment, no longer conforms to this chapter pertaining to the district in which it is located.

Subp. 53. **Nonconforming use.** "Nonconforming use" means a use of land or a building that lawfully existed prior to the effective date of the applicable rule or amendment, whichever is later, and that, on or after the effective date of the applicable rule or amendment, does not conform to the use rules of the district in which it is located.

Subp. 54. **Nuisance.** "Nuisance" means an unreasonably offensive, annoying, unpleasant, or obnoxious thing or practice; a cause or source of unreasonable annoyance, especially a continuing or repeating invasion of any physical characteristics of activity or use across a property line that can be perceived by or affects a human being; or the unreasonable generation of an excessive or concentrated movement of people or things including, but not limited to, noise, dust, smoke, odor, glare, fumes, flashes, vibration, shock waves, heat, electronic or atomic radiation, objectionable effluent, passenger traffic, invasion of nonabutting street frontage by traffic, or noise or congregation of people, particularly at night.

Subp. 55. **Nursing home.** "Nursing home" has the meaning given in Minnesota Statutes, section 144A.01, subdivision 5.

Subp. 56. **Obscuring fence.** "Obscuring fence" means a fence that is 80 percent or more opaque.

Subp. 57. **Off-street parking lot.** "Off-street parking lot" means a facility providing vehicular parking spaces along with adequate drives and aisles for maneuvering, so as to provide access for entrance and exit for the parking of more than three vehicles. This includes adequate driveways, access ways, parking bays, garages, or combinations thereof, but does not include public roads, alleys, and streets.

Subp. 58. **One-family dwelling.** "One-family dwelling" means a building designed exclusively for and occupied by one family.

Subp. 59. **Parking space.** "Parking space" means an area of definite length and width, exclusive of drives, aisles, or entrances giving access, that is fully accessible for the parking of a permitted vehicle.

Subp. 60. **Pawn shop.** "Pawn shop" means a place where a broker or other personnel loans money on deposit or pledge of personal property or other valuable thing.

Subp. 61. **Person.** "Person" includes an individual, a corporation, a partnership, an incorporated association, or any other similar entity.

Subp. 62. **Pervious pavement.** "Pervious pavement" means pavement that is designed and maintained to allow precipitation to infiltrate into the ground to reduce the volume and slow the rate of storm water runoff. Pervious pavement materials include pervious interlocking concrete paving blocks, concrete grid pavers, perforated brick pavers, and similar materials.

Subp. 63. **Principal building.** "Principal building" means a building in which the principal use of the zoning lot upon which it is situated is conducted.

Subp. 64. **Principal use.** "Principal use" means a use that is the primary use of the zoning lot upon which it is situated and that is:

A. specifically listed in the table of uses as a permitted or conditional use in the zoning district in question; or

B. wholly consistent with the purpose of the district and the general character of the enumerated principal uses of that district.

Subp. 65. **Public utility.** "Public utility" means a person duly authorized under federal, state, or municipal laws to furnish to the public gas, steam, electricity, sewage disposal, communication, telegraph, transportation, or water.

Subp. 66. **Restaurant.** "Restaurant" means a business establishment whose principal business is the selling of unpackaged food to the customer in a ready-to-consume state, in individual servings or in nondisposable containers, and where the customer consumes these foods while seated at tables or counters located within a building.

Subp. 67. **Setback.** "Setback" means the distance required to obtain front, side, and rear yard open space provisions of this chapter, measured from the lot line to the above-grade faces of the building.

Subp. 68. **Sign.** "Sign" means words, numerals, figures, devices, designs, or trademarks used to show or advertise a person, firm, profession, business, service, product, or message, or to provide information, warnings, or directions, including the kinds of signs described in items A to Y.

A. "Accessory sign" means a sign that pertains to the principal use of the premises.

B. "Advertising sign" means a nonaccessory sign related to an activity, service, or business not carried out on the premises upon which the sign is placed.

C. "Announcement sign" means a business sign that provides an announcement of church services or other religious activities, or a directory of offices or activities within a building or group of buildings.

D. "Billboard" means an advertising sign more than 16 square feet in area.

E. "Business sign" means an accessory sign relating to the activity, service, or business conducted on the premises upon which the sign is placed.

F. "Canopy sign" means a sign painted, stamped, perforated, stitched, or otherwise applied either on an awning or canopy or its valance.

G. "Directional sign" means a sign that conveys information or requirements about orientation and direction.

H. "Flashing, animated, or moving sign" means a sign that intermittently reflects lights from either an artificial source or from the sun; a sign that has movement of any illumination, such as intermittent flashing, scintillating, or varying intensity; or a sign that has any visible portions in motion, either constantly or at intervals, that may be caused either by artificial or natural sources.

I. "Freestanding sign" means a sign not attached to any building and supported by uprights or braces, or mounted on the ground. Pylon and monument signs are types of freestanding signs.

J. "Identification and name plate" means a sign stating the name of a person, firm, or institution.

K. "Illuminated sign" means a sign upon which artificial light is directed or which has internal lighting.

L. "Marquee sign" means a permanent roofed structure attached to and supported by the building and projecting over public right-of-way.

M. "Monument sign" means a freestanding sign not attached to a building where the base of the sign structure is on the ground or a maximum of 12 inches above the adjacent grade, and the width of the top of the sign is no more than 120 percent of the width of the base.

N. "Nonaccessory sign" means a sign that does not pertain to the principal use of the premises.

O. "Political sign" means a temporary sign that displays information pertaining to an upcoming governmental district, city, county, state, or national election, or an issue pending before the legislature.

P. "Projecting sign" means a sign attached to a building or other structure and extending beyond the surface of the portion of the building line or extending over public property.

Q. "Pylon sign" means a freestanding sign supported by one or more poles with a clear space of ten feet or greater between the bottom of the face of the sign and the ground.

R. "Real estate sign" means a business sign placed upon a property advertising that particular property for sale, for rent, or for lease.

S. "Real estate development sign" means a business sign placed on the premises of a subdivision or other real estate development.

T. "Roof sign" means a sign, any part of which is erected upon, over, or above a roof of a building.

U. "Temporary sign" means any type of sign, flag, banner, or similar object other than a political sign intended to be displayed for a short time for special events except as otherwise regulated in this chapter. A vehicle or portable sign is not a temporary sign.

V. "Transit shelter sign" or "bench sign" means an advertising sign affixed to the side or length of a transit shelter or bench that is unrelated to the transit purpose of the shelter or bench.

W. "Vehicle sign" or "portable sign" means a portable business sign painted on or attached to a vehicle or a chassis with wheels, skids, or other frame that is not permanently mounted in the ground or attached to a building and used for temporary messages or announcements.

X. "Wall sign" means a sign erected against a wall of a building or structure with the exposed face of the sign in a plane approximately parallel to the plane of the wall and not extending more than 12 inches beyond the surface of the portion of the building wall on which it is erected. Wall signs include murals, whether painted or applied upon the walls with a commercial message or content. In the case of murals, any lettering or symbols that relate directly to the nature of business on the premises shall be considered in the allocation of signage for the property.

Y. "Window sign" means a permanent or temporary sign posted inside a storefront or window that provides or advertises information concerning certain products, prices, or other messages directly related to the conduct of business on the premises. Window sign does not include the temporary posting of flyers or promotions for timely events of a religious, civic, or neighborhood nature.

Subp. 69. **Sign area.** "Sign area" means the area within a continuous perimeter enclosing the limits of writing, representation, and any other integral part of the sign display, excluding the supporting structure. When the faces of a back-to-back sign are parallel or within 35 degrees of parallel, the sign face area shall be determined on the basis of only one side of the sign. If the sign faces are not within 35 degrees of parallel, the sign face area shall be determined on the basis of the sum of the areas of each sign face.

Subp. 70. **Story.** "Story" means the part of a building included between the surface of one floor and the surface of the next floor or, if the topmost floor, the ceiling or roof next above. A basement is not counted as a story.

Subp. 71. **Story, half.** "Story, half" means an uppermost story lying under a sloping roof having an area of at least 200 square feet with a clear height of at least seven feet six inches. For the purpose of this chapter, the gross floor area is only that area having at least four feet clear height between the floor and ceiling.

Subp. 72. **Street.** "Street" means a public dedicated right-of-way, other than an alley, that affords the principal means of access to abutting property.

Subp. 73. **Street line.** "Street line" means the property line separating private or public property from a designated street right-of-way.

Subp. 74. **Supervised living facility licensed by the Department of Human Services.** "Supervised living facility licensed by the Department of Human Services" means one

main building or portion of the building on one zoning lot where children or persons with developmental or physical disabilities or who have a chemical dependency reside on a 24-hour basis under the auspices of a program licensed by the Minnesota Department of Human Services to provide lodging, care, training, education, supervision, habilitation, rehabilitation, or treatment they need but that for any reason cannot be furnished in their own homes. Supervised living facilities specifically do not include hospitals, prisons, juvenile detention centers, reformatories, residential facilities for programs licensed by the Minnesota Department of Corrections, foster homes, or treatment centers operated by the commissioner of human services.

Subp. 75. **Supervised living facility licensed by the Department of Health.** "Supervised living facility licensed by the Department of Health" means one building or portion of the building on one zoning lot that is licensed by the commissioner of health as a rooming or boarding house and receives 50 percent or more of its residents under a contract with state or local government human service agencies to provide lodging for people with developmental disabilities or chemical dependency.

Subp. 76. **Through lot.** "Through lot" means an interior lot with frontage on two streets.

Subp. 77. **Townhouse dwelling.** "Townhouse dwelling" means a one-family dwelling unit, within a linear group of horizontally attached dwellings, each having a private entrance.

Subp. 78. **Transitional housing facility.** "Transitional housing facility" means a building or portion of a building on one zoning lot where persons who may or may not have access to traditional or permanent housing, but who are capable of living independently within a reasonable period of time, reside on a 24-hour-per-day basis for approximately 30 days, and participate in program activities to facilitate their independent living.

Subp. 79. **Two-family dwelling.** "Two-family dwelling" means a building designed exclusively for occupancy by two families living independently of each other.

Subp. 80. **Underground structure.** "Underground structure" means a completed building designed to be built partially or wholly below grade that was not intended to serve as a substructure or foundation of a building.

Subp. 81. **Usable floor area.** "Usable floor area" means the floor area used for or intended to be used for the sale of merchandise or services, or for use to serve patrons, clients, or customers, and all that area devoted to employee workspace, but excluding floor area that is used or intended to be used principally for the storage of merchandise, hallways, or elevator or stair bulkheads, or for utilities or sanitary facilities.



Subp. 82. **Use.** "Use" means the principal purpose for which land or a building is arranged, designed, or intended, or for which land or building is or may be occupied.

Subp. 83. **Used for.** "Used for" includes arranged for, designed for, intended for, maintained for, or occupied for.

Subp. 84. **Wind energy conversion system.** "Wind energy conversion system" means an electrical generating facility composed of one or more wind turbines and accessory facilities, including power lines, transformers, substations, metrological towers, and similar components that operate by converting the kinetic energy of wind into electrical energy. The energy may be used on site or distributed into the electrical grid.

Subp. 85. **Wind turbine.** "Wind turbine" means a piece of electrical generating equipment that converts the kinetic energy of flowing wind into electrical energy through the use of airfoils or similar devices to capture the wind.

Subp. 86. **Yard.** "Yard" means the open spaces on the same lot with a principal building, unoccupied and unobstructed from the ground upward, except as otherwise provided in items A to C and this chapter.

A. "Front yard" means an open space extending the full width of the lot, the depth of which is the minimum horizontal distance between the front lot lines and the nearest point of the principal building.

B. "Rear yard" means an open space extending the full width of the lot, the depth of which is the minimum horizontal distance between the rear lot line and the nearest point of the principal building. In the case of a corner lot, the rear yard may be opposite either street frontage.

C. "Side yard" means an open space between a principal building and the side lot line, extending from the front yard to the rear yard, the width of which is the horizontal distance from the nearest point of the side lot line to the nearest point of the principal building.

Subp. 87. **Zoning administrator.** "Zoning administrator" means an employee of the board designated by the board upon the recommendation of the executive secretary to implement, monitor

compliance with, and manage all parts of the zoning rules under this chapter in the Capitol area. The executive secretary shall serve as the zoning administrator in the designee's absence.

Subp. 88. **Zoning lot.** "Zoning lot" means a single tract of land, composed of one or more lots located within a single block, that, at the time of filing for a building permit, is designated by its owner or developer as a tract to be used, developed, or built upon as a unit under single ownership or control. A zoning lot must be in one zoning district and satisfy this chapter with respect to area, size, dimension, and frontage as required in the district in which the zoning lot is located.

Statutory Authority: *MS s 15B.06*

History: *34 SR 900*

Published Electronically: *January 15, 2010*

2400.2100 ZONING DISTRICTS ESTABLISHED.

The following zoning districts for the Capitol area are established:

- A. government district (G-1);
- B. government district (G-2);
- C. moderate density residential district (RM);
- D. mixed use district (MX);
- E. mixed use - downtown district (MXD); and
- F. central corridor overlay district (CC-O).

Statutory Authority: *MS s 15B.06*

History: *34 SR 900*

Published Electronically: *January 15, 2010*

2400.2105 ZONING MAP.

Subpart 1. **Establishment of zoning districts.** The Capitol area is divided into zoning districts as shown on the official zoning map entitled Zoning Districts for the Capitol area in subpart 2. The map and any amendments with all explanatory material are part of this chapter.

Subp. 2. **Zoning districts for the Capitol area.**

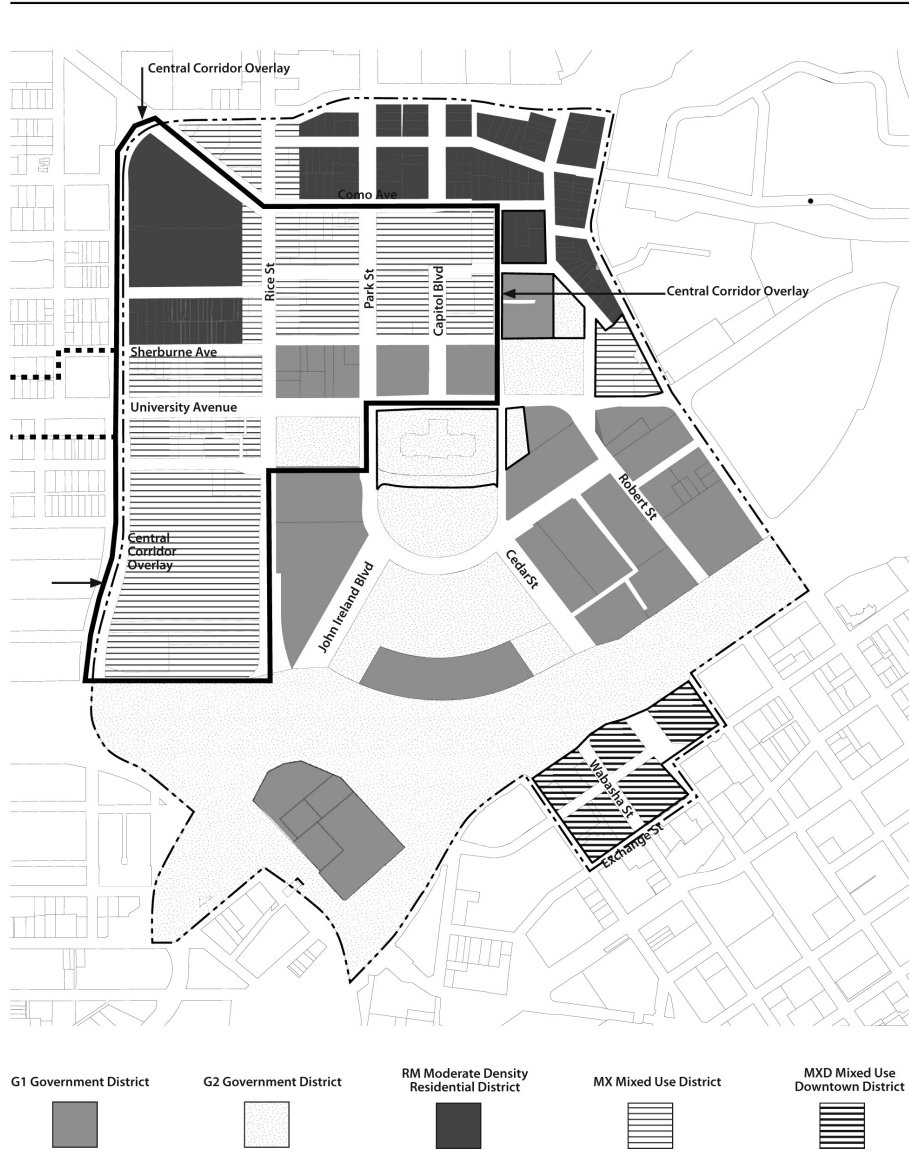

Statutory Authority: *MS s 15B.06*

History: *34 SR 900*

Published Electronically: *January 15, 2010*

2400.2110 BOUNDARIES.

Where uncertainty exists with respect to the boundaries of any of the districts established in this chapter as shown on the official Capitol area zoning district map in part 2400.2105, subpart 2, then items A to D govern.

A. Where district boundaries are indicated as approximately following the center line of streets or highways, street lines, or highway right-of-way lines, the center lines are the boundaries.

B. Where district boundaries are indicated as approximately following the lot lines, the lot lines are the boundaries.

C. Where district boundaries are indicated as being approximately parallel to the center lines of the street or the center lines of right-of-way lines of highways or railroads, the district boundaries shall be construed as being parallel to the center lines and at the distances from them indicated on the Capitol area zoning district map.

D. Where unzoned property exists, or where, due to the scale, lack of detail, or illegibility of the zoning map, there is any uncertainty, contradiction, or conflict as to the intended location of any district boundaries shown on the map, the exact location of district boundary lines shall be determined by the board upon the written application of a property owner or upon its own motion.

Statutory Authority: *MS s 15B.06*

History: *34 SR 900*

Published Electronically: *January 15, 2010*

2400.2200 GENERAL PROVISIONS.

Subpart 1. **Scope.** The district regulations in this part list permitted and conditional uses in the primary zoning districts and note applicable development standards and conditions.

Subp. 2. **Permitted uses.** Uses specified with a "P" are permitted in the district or districts where designated, provided that the use complies with this chapter.

Subp. 3. **Conditional uses.** Uses specified with a "C" are allowed as a conditional use in the district or districts where designated, provided that the use complies with this chapter. Persons wishing to establish, change, or expand a conditional use shall obtain a permit as specified in part 2400.3155.

Subp. 4. **Permitted or conditional uses.** Uses listed as "P/C" may be either permitted or conditional depending on their compliance with the standards and conditions in parts 2400.2700 to 2400.2740.

Subp. 5. **Prohibited uses.** Any use not listed as either "P" or "C" in a particular district, or any use not determined by the board to be substantially similar to a listed permitted or conditional use, shall be prohibited in that district.

Subp. 6. **Development standards.** A "Y" in the column entitled "Standards" indicates that permitted and conditional uses are subject to the specific standards and conditions of parts 2400.2700 to 2400.2740, in addition to all other provisions of this chapter.

Subp. 7. **Combination of uses.** Any permitted or conditional uses may be combined on a parcel or within a building, provided that all uses meet other provisions of this chapter, including any specific development standards.

Statutory Authority: *MS s 15B.06*

History: *34 SR 900*

Published Electronically: *January 15, 2010*

2400.2205 TABLE OF PERMITTED AND CONDITIONAL USES BY DISTRICT.

	G-1	G-2	RM	MX	MXD	Standards
STATE INSTITUTIONS AND FACILITIES						
The Capitol of Minnesota, including but not limited to executive, judicial, and legislative uses	P	P				
Commemorative works, monuments, or memorials	P	C	C	C	C	Y
State of Minnesota offices, including but not limited to executive, judicial, legislative, and administrative offices	P			P	P	
State of Minnesota museums, historical centers, and tourist information facilities	P			P	P	
State-owned parking facilities, surface lots	C	C		P		Y
State-owned parking facilities, underground	P	P		P		
State-owned parking facilities, structured, aboveground	P			P	P	
Permanent open spaces that preserve and enhance the Capitol area, including but not limited to lawns, gardens, landscaped areas, and plazas	P	P	P	P	P	
Underground structures containing permitted uses	P	P	P	P	P	Y
Other uses necessary for the satisfactory and efficient operation of the facilities of state government and to provide adequate public access to them	P	C		C	C	

CIVIC AND INSTITUTIONAL USES

Day care centers, home day care	C	P/C	P	P	Y
Public parks and recreation facilities	P	P	P	P	
Public buildings and uses	P	P	P	P	
Place of worship, including church, synagogue, temple, or mosque	C	P	P	P	Y
Residence associated with place of worship, including rectory or convent	C	P	P	P	
School, grades K-12	C	P	C	P	Y
Trade school, business school, art school, or similar enterprise			C	P	Y
RESIDENTIAL - FAMILY LIVING					
One-family detached dwellings		P	P		
Two-family dwelling		P	P		
Townhouse dwellings		P	P		
Multiple-family dwellings, three and four unit		P	P		
Multiple-family dwellings, five or more units		C	P	P	Y
Carriage house dwelling		P	P	P	Y
Housing for the elderly		C	P	P	Y
CONGREGATE LIVING					
Foster home, freestanding foster care home		P	P	C	Y
Community residential facility, licensed human service		C	C	C	Y
Community residential facility, licensed correctional or Health Department licensed		C	C	C	Y
Emergency housing facility; shelter for battered persons, transitional housing facility		C	C	C	Y
Hospice		C	C	C	Y
Nursing home, boarding care home, assisted living		C	C	C	Y

Rooming house, boarding house	C	C			Y
MIXED COMMERCIAL-RESIDENTIAL USES					
Home occupation	P/C	P/C	C		Y
Live-work unit	C	P	P		Y
Mixed commercial-residential use		P	P		
PUBLIC SERVICES AND UTILITIES					
Antenna, cellular telephone	P/C	P/C	P/C	P/C	Y
Electric transformer or gas regulator substation	C	C	C	C	
Utility or public service building	C	C	C	C	
COMMERCIAL USES					
Offices:					
Administrative or professional office	C		P	P	
Artist, photographer, or other professional studio	C		P	P	
Medical Facilities:					
Clinic, medical or dental	C		P	P	
Hospital	C		C	C	Y
Veterinary clinic			P	P	Y
Retail Sales and Service:					
General retail*	C	C	P	P	Y
Bank, credit union	C		P	P	
Business sales and service			P	P	
Dry cleaning, commercial laundry			P	P	
Food and related goods sales	C		P	P	
Garden shop, greenhouse			C		
Laundromat, self-service			P	P	

Mortuary, funeral home			C		
Photocopying	C		P	P	
Post office	P		P	P	
Service business*	C	C	P	P	Y
Small appliance or engine repair			C		
Outdoor sales, primary and accessory			C		
Food and Beverages:					
Catering			P	P	
Coffee shop, tea house	P	C	P	P	Y
Restaurant	P		P	P	Y
Restaurant, fast food without drive through			C	C	Y
Bar, tavern			C	C	Y
Lodging:					
Bed and breakfast residence		C	C		Y
Hotel, inn, motel			P	P	
Commercial Recreation and Entertainment:					
Health, sports club	C		C	P	
Indoor recreation			C	P	
Theater, assembly hall	C		C	P	
Automobile Services:					
Auto convenience market			C		Y
Car wash			C		Y
Auto service station			C		Y
Auto repair station			C		Y
PARKING AND TRANSPORTATION					
Parking facility, public or commercial	C	C	C	C	Y

Public transit stations, bus stops, and other related facilities	C	C	P	C	P	Y
--	---	---	---	---	---	---

LIMITED PRODUCTION, PROCESSING, AND STORAGE

Limited production and processing*				C		
Mail order house				C	C	
Printing and publishing				C	C	
Wholesale establishment				C	C	

ACCESSORY BUILDINGS, STRUCTURES, AND USES

Amateur radio antenna, satellite dish	C		C	P	C	Y
Outside storage of construction materials and equipment, temporary	C		C	C	C	
Off-street parking, open or enclosed	C	C	P	P	P	
Private recreational facility for multifamily housing			C	C	C	Y
Private swimming pool			C	C	P	Y
Solar energy systems or devices	C	C	C	C	C	Y
Storage within enclosed building	P		P	P	P	
Wind energy systems or devices	C		C	C	C	Y

*See list of typical uses within these categories in parts 2400.2700 to 2400.2740.

Statutory Authority: *MS s 15B.06*

History: *34 SR 900*

Published Electronically: *January 15, 2010*

2400.2210 G-1 GOVERNMENT DISTRICT.

Subpart 1. **District intent.** The intent of the G-1 Government District is to provide for the orderly growth of state government and the preservation and enhancement of existing structures within the Capitol area.

G-1 GOVERNMENT DISTRICT

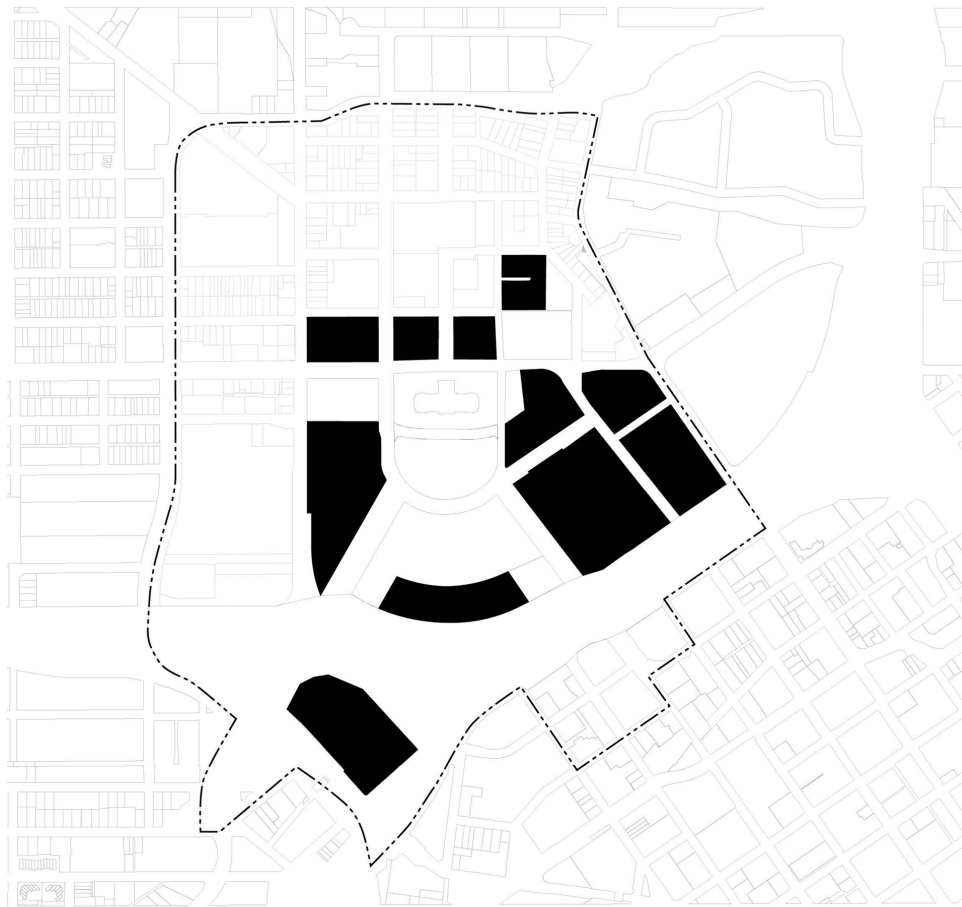

Building and Parking Placement Example

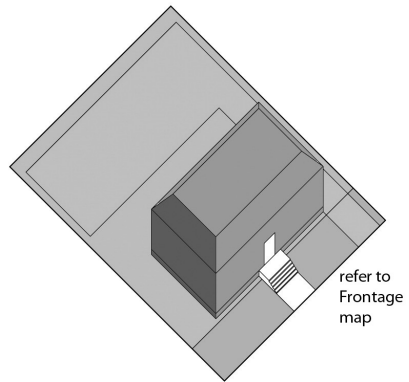

Building Height Measurement Example

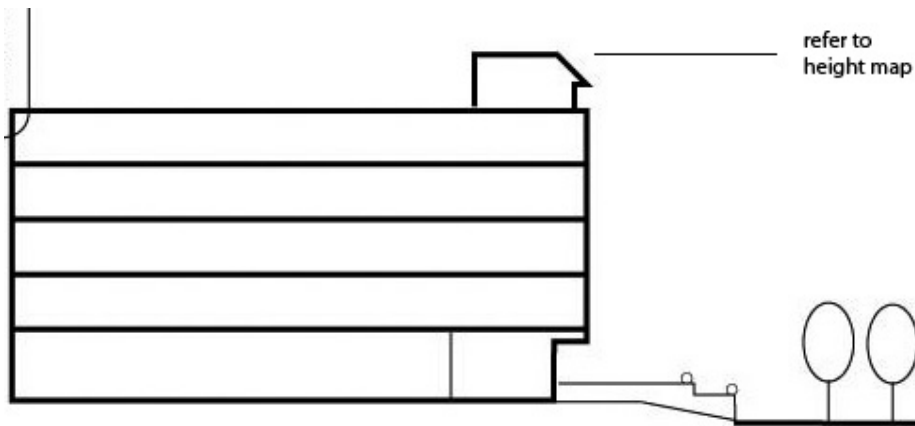

Examples of Typical Buildings and Views, G-1 District



Subp. 2. **Building placement.** The following minimum setbacks apply to building placement in the G-1 district:

	Minimum setback
Front yard	See frontage map
Corner side yard	Zero feet

Interior side yard	Zero feet
Rear yard	Zero feet

Subp. 3. **Building types.** The following building types, described in part 2400.2500, are considered appropriate for the G-1 district. Other building types are acceptable upon approval by the zoning administrator, provided that they meet the lot, height, and frontage requirements and design standards of this chapter.

Building Type	Minimum Lot Width
Civic building	60 feet
Parking building	60 feet
Podium building	60 feet
Liner building	60 feet

Subp. 4. **Parking placement.** Surface parking must be located behind the rear plane of the principal building on the lot. On corner lots, surface parking may be located in a side yard but shall be set back at least 30 feet from the corner of the property. Surface parking must be screened and landscaped as specified in part 2400.2630.

Subp. 5. **Lot area and coverage.** Lot area and coverage requirements for the G-1 district are as follows:

Building Type	Minimum lot size
All buildings	10,000 square feet
Maximum impervious coverage	85 percent of lot area

Subp. 6. **Building height.** Building heights must comply with part 2400.2300.

Statutory Authority: *MS s 15B.06*

History: *34 SR 900*

Published Electronically: *January 15, 2010*

2400.2215 G-2 GOVERNMENT DISTRICT.

Subpart 1. **District intent.** The intent of the G-2 Government District is to provide for the preservation and enhancement of the State Capitol, and the creation and preservation of open space within the Capitol area.

G-2 GOVERNMENT DISTRICT

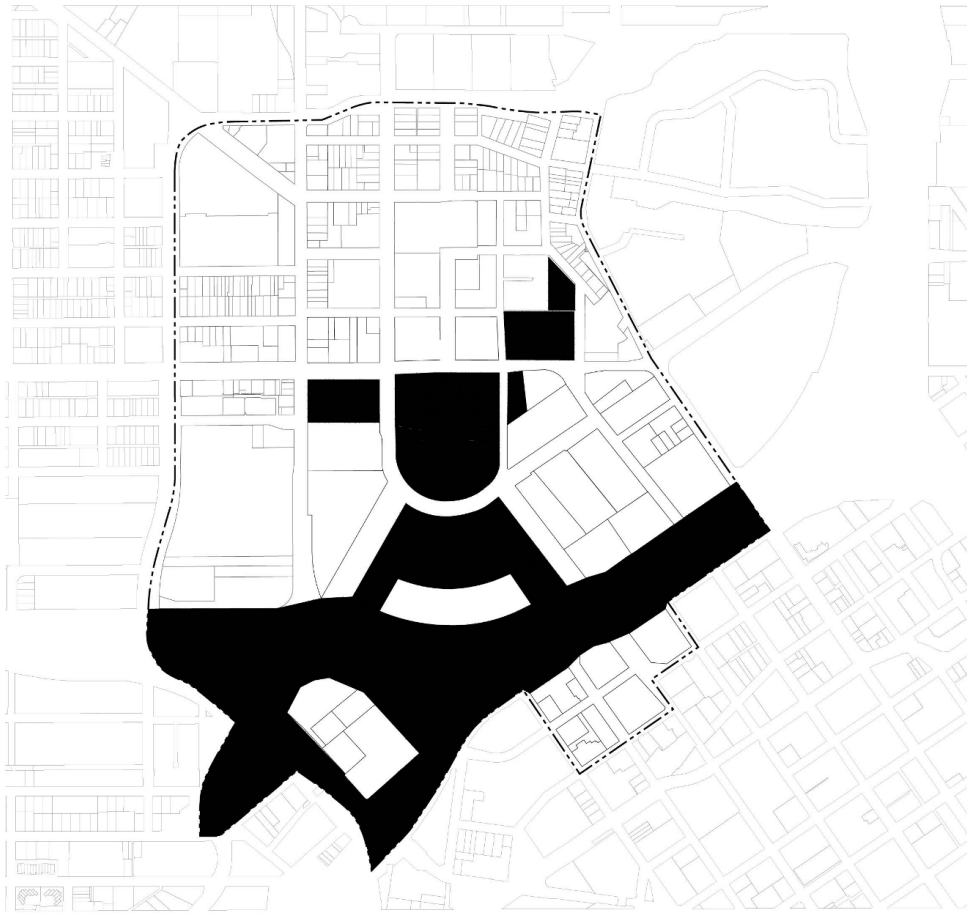

Examples of Typical Buildings and Views, G-2 District





Subp. 2. **Parking placement.** Surface parking within the G-2 district is considered an interim use, with the intent that it will ultimately be replaced with underground parking or structured parking in another zoning district. Surface parking must be screened from the streets and adjacent uses as specified in part 2400.2630.

Statutory Authority: *MS s 15B.06*

History: *34 SR 900*

Published Electronically: *January 15, 2010*

2400.2220 RM MODERATE DENSITY RESIDENTIAL DISTRICT.

Subpart 1. **District intent.** The RM Moderate Density Residential District is intended to protect the residential qualities and character of neighborhoods adjacent to the Capitol campus while encouraging infill and redevelopment for a range of moderate-density housing types and limited service uses. New development must be at a human scale, oriented to the street, and designed with sensitivity to Capitol views and public spaces.

RM MODERATE DENSITY RESIDENTIAL DISTRICT



Building and Parking Placement Example

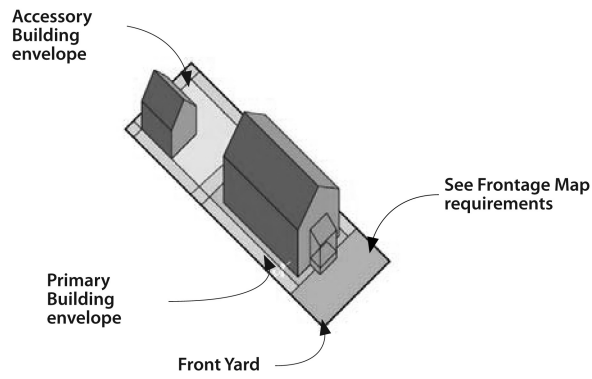

Building Height Measurement Example

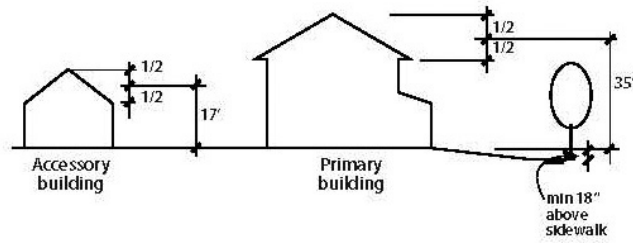

Examples of Typical Buildings and Views, RM District





Subp. 2. **Building placement.** The following minimum setbacks apply to building placement in the RM district:

Principal Building	Minimum Setback
Front yard	See frontage map
Corner side yard	Five feet
Interior side yard	Five feet
Rear yard	25 feet
Accessory Building	
Corner side yard	Five feet
Interior side yard	Three feet
Rear yard	Three feet
Rear yard from alley	One foot
Separation from principal building	Six feet

Subp. 3. **Building types.** These building types, described in part 2400.2500 are considered appropriate for the RM district. Other building types are acceptable upon approval by the zoning administrator, provided that they meet the lot, height, and frontage requirements and design standards of this chapter.

Building Type	Minimum Lot Width
One-family	35 feet

Two-family twin	20 feet/unit
Two-family duplex	35 feet
Townhouse	20 feet
Small apartment (3-4 units)	40 feet
Large apartment (5 plus units)	50 feet
Carriage house	Not applicable
All nonresidential buildings	50 feet

Subp. 4. **Parking placement.** Parking may be located in the following locations:

- A. within an attached or detached garage;
- B. on a driveway leading to a garage, located outside of the front yard setback. Parked vehicles on driveways shall not block the sidewalk; and
- C. on a paved area meeting the following standards:
 - (1) located in a side or rear yard behind the rear plane of the principal building on the lot; and
 - (2) set back a minimum of three feet from side and rear lot lines, including alleys.

Subp. 5. **Lot area and coverage.** Lot area and coverage requirements in the RM district are as follows:

Building type	Minimum lot size
Single-family detached	5,000 square feet
Two-family (per unit)	3,000 square feet
Townhouse (per unit)	2,400 square feet
Multifamily (per unit)	1,200 square feet
Maximum impervious coverage	40 percent lot area
Maximum accessory building coverage	35 percent rear yard

Subp. 6. **Building height.** Building heights in the RM district must comply with part 2400.2300 and the following additional maximum height requirements:

Building	Maximum height
Primary building	35 feet
Accessory building	17 feet
Carriage house	25 feet

Statutory Authority: *MS s 15B.06*

History: *34 SR 900*

Published Electronically: *January 15, 2010*

2400.2225 MX MIXED USE DISTRICT.

Subpart 1. **District intent.** The intent of the MX Mixed Use District is to foster vital commercial streets that serve the needs of surrounding neighborhoods and the Capitol campus, and to encourage pedestrian-oriented and transit-supportive development along these corridors.

MX MIXED USE DISTRICT



Building and Parking Example

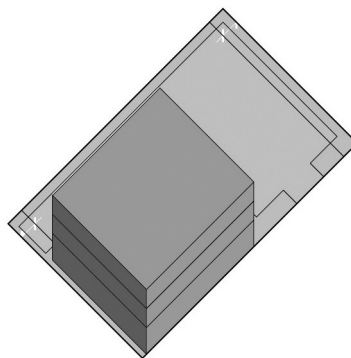

Building Height Measurement Example

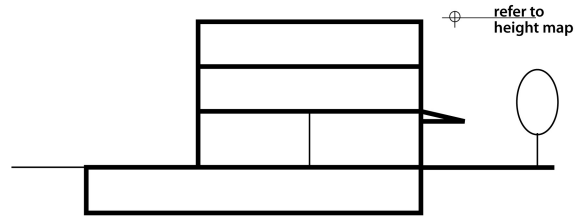

Examples of Typical Buildings in the MX District





Subp. 2. **Building placement.** The following minimum setbacks apply to building placement in the MX district:

Principal Building	Minimum Setback
Front yard	See frontage map
Corner side yard	Zero feet interior
Side yard	10 feet adjacent to residential use
Rear yard	Zero feet

Buildings accessory to nonresidential uses must meet the same setback requirements as principal buildings.

Buildings accessory to residential uses must meet the setback requirements of the RM district.

Subp. 3. **Building types.** These building types, described in part 2400.2500 are considered appropriate for the MX district. Other building types are acceptable upon approval by the zoning administrator, provided that they meet the lot, height, and frontage requirements and design standards of this chapter.

Building Type	Minimum Lot Width
Civic building	60 feet
Commercial block building	35 feet
Podium building	60 feet
Parking building	60 feet

Liner building	60 feet
Single-family detached	35 feet
Two-family twin	25 feet
Two-family duplex	35 feet
Townhouse	20 feet
Small apartment (3-4 units)	40 feet
Large apartment (5 plus units)	50 feet
Carriage house	Not applicable

Subp. 4. Parking placement.

A. Residential use parking may be located within an attached or detached garage, on a driveway leading to a garage, outside the front yard setback, or on a paved area meeting the following standards:

- (1) the parking is located in a side or rear yard behind the rear plane of the principal building on the lot;
- (2) the parking is set back a minimum of three feet from side and rear lot lines, including alleys; and
- (3) parked vehicles on driveways must not block the sidewalk.

B. Nonresidential or mixed use structured parking is encouraged.

(1) Surface parking must be located behind the rear plane of the principal building on the lot or within a side yard provided that no more than 70 feet of lot frontage along the primary abutting street is occupied by parking or driveways.

(2) On corner lots, surface parking must be set back at least 30 feet from the corner of the property. Surface parking must be screened and landscaped as specified in part 2400.2630.

Subp. 5. Lot area and coverage. Lot area and coverage requirements in the MX district are as follows:

Building Type	Minimum Lot Size
Nonresidential or mixed use	None
Single-family detached	5,000 square feet
Two-family (per unit)	3,000 square feet

Townhouse (per unit)	2,400 square feet
Multifamily (per unit)	1,200 square feet
Maximum impervious coverage	85 percent of lot area

Subp. 6. **Building height.** Building heights in the MX district must comply with part 2400.2300.

Statutory Authority: *MS s 15B.06*

History: *34 SR 900*

Published Electronically: *January 15, 2010*

2400.2230 MXD MIXED USE DOWNTOWN DISTRICT.

Subpart 1. **District intent.** The intent of the MXD Mixed Use Downtown District is to ensure that the portion of the Capitol area that extends into downtown St. Paul maintains its visual relationship to the Capitol campus while fostering a vital mix of uses that support both the Capitol campus and the downtown.

MXD DISTRICT



Building and Parking Placement Example

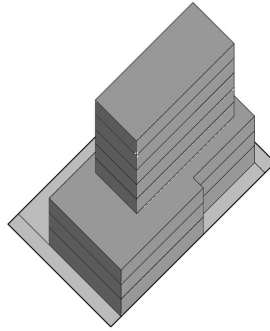

Building Height Measurement Example

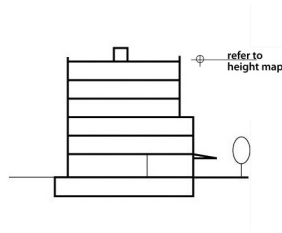

Examples of Typical Buildings in the MXD District





Subp. 2. **Building placement.** The following minimum setbacks apply to building placement in the MXD district:

Primary Building Zone Setbacks

Front yard	See frontage map
Corner side yard	Zero feet
Interior side yard	Ten feet if adjacent to residential use
Rear yard	Zero feet

Subp. 3. **Building types.** These building types, described in part 2400.2500, are considered appropriate for the MXD district. Other building types are acceptable upon approval by the zoning administrator, provided that they meet the lot, height, and frontage requirements and design standards of this chapter.

Building Type	Minimum Lot Width
Commercial block building	35 feet
Podium building	60 feet
Parking building	60 feet
Liner building	60 feet
Large apartment (5 plus units)	50 feet

Subp. 4. **Parking placement.** Off-street parking is not required. Surface parking is prohibited.

Structured parking must be underground or fully enclosed by other permitted uses at ground level, with the exception of necessary entrances and exits.

Subp. 5. **Lot area and coverage.** Lot area and coverage requirements in the MXD district are as follows:

Building Type	Minimum Lot Size
All buildings	None
Maximum impervious coverage	100 percent of lot area

Subp. 6. **Building height.** Building heights in the MXD district must comply with part 2400.2300.

Statutory Authority: *MS s 15B.06*

History: *34 SR 900*

Published Electronically: *January 15, 2010*

2400.2235 CENTRAL CORRIDOR (CC) OVERLAY DISTRICT.

Subpart 1. **District intent.** The Central Corridor (CC) Overlay District is established to promote development and redevelopment along the planned central corridor light rail transit line. It is intended to foster development that intensifies land use and economic value; to promote a mix of uses that will enhance the livability of station areas; to improve pedestrian connections, traffic, and parking conditions; and to foster high quality buildings and public spaces that help create and sustain long-term economic vitality.

Subp. 2. **Boundaries.** The boundaries of the CC Overlay District are as shown on the zoning map in part 2400.2105.

Subp. 3. **Relationship to other regulations.** Properties located within the CC Overlay District are subject to the provisions of the primary zoning district and the CC Overlay District. Where

provisions of the overlay district conflict with the primary zoning district, the provisions of the overlay district apply.

Subp. 4. **Prohibited uses.** The following uses are prohibited in the CC Overlay District:

- A. auto convenience market;
- B. auto service station;
- C. auto repair station; and
- D. car wash.

Subp. 5. **Minimum intensity and frontage use.** The following standards apply to new buildings in the CC Overlay District:

A. A minimum floor area ratio of 1.0 is required. Public gathering space, landscaped areas, outdoor seating areas, and areas for public art may be counted toward building square footage in calculating the minimum floor area ratio.

B. A new building with less than the required floor area ratio is allowed on a developed zoning lot where an existing building will remain, provided that the board determines:

- (1) total lot coverage and floor area ratio for the zoning lot are not reduced; and
- (2) the new development provides enhanced landscaping, pedestrian realm enhancements, or building design elements that improve the aesthetic appeal of the site.

C. New buildings shall be a minimum of two stories in height.

D. A minimum of 50 percent of ground floor building frontage along University Avenue and Rice Street must be occupied by uses that encourage pedestrian activity and interest, including, but not limited to, retail and service uses, meeting rooms, eating areas, and offices serving the public. Buildings owned or lease-purchased by the state are exempt from this requirement, although active uses are encouraged on the ground floor frontage of state buildings.

Subp. 6. **Parking standards.**

A. For nonresidential uses, the number of off-street parking spaces required is a minimum of 60 percent to a maximum of 85 percent of the off-street parking standards in part 2400.2820. The maximum may be exceeded if the additional parking spaces are structured in a ramp or deck, underground, or within a building. State office buildings and other state uses are exempt from the maximum parking requirement.

B. There is no minimum parking requirement for residential uses. A maximum of one space per unit may be provided. The maximum may be exceeded if the additional parking spaces are structured.

Subp. 7. **Exemptions.** Where an existing building or its accessory parking does not conform to the CC Overlay District requirements or serves an existing nonconforming use, the building may

be expanded without fully meeting the requirements of this part as long as the expansion does not increase the nonconformity.

Statutory Authority: *MS s 15B.06*

History: *34 SR 900*

Published Electronically: *January 15, 2010*

2400.2300 HEIGHT DISTRICTS.

Subpart 1. **Requirement.** In order to preserve the State Capitol Building as the dominant structure in the Capitol area, no building shall be constructed to a height greater than the maximum height permitted in the height district, as shown on the map in subpart 6. The maximum height is stated as elevation above sea level, in contrast to St. Paul datum. Conversion is accomplished by adding 694.1 feet to the St. Paul datum in order to determine elevation above sea level. The maximum heights are as described in subparts 2 to 5.

Subp. 2. **Height district 1.** Maximum height in height district 1 is established as 944.0 feet above sea level. This elevation corresponds to the height of the Capitol Building exclusive of the dome; generally, this would allow a building height of four to six stories in the Capitol area.

Within height district 1 in the east Capitol area, building height is further restricted as specified in items A to D.

A. Subdistrict 1a: An area between Robert Street and East Central Park Street, and its geometric extension, from the southeast side of Aurora Avenue to a line extending from the southeast side of 14th Street. Maximum height is 900.1 feet above sea level, 206 feet above St. Paul datum.

B. Subdistrict 1b: An area between Jackson Street and East Central Park Street, and its geometric extension, from the northwest side of 13th Street, and its geometric extension, to a line 250 feet north of University Avenue, drawn east to west between Jackson Street and Robert Street, then turning south along Robert Street to its intersection with University Avenue, then west on University Avenue for 350 feet, and again south to meet the line extending from East Central Park Street. Subdistrict 1a is excluded from the area described in this item. Maximum height is 888.1 feet above sea level, 194 feet above St. Paul datum.

C. Subdistrict 1c: An area between Jackson Street and East Central Park Street from the northwest side of 13th Street, and its geometric extension, to the southeast side of Columbus Avenue, and its geometric extension, and that area between Cedar Street and Minnesota Street, and Columbus Avenue and 12th Street. Maximum height is 876.1 feet above sea level, 182 feet above St. Paul datum.

D. Subdistrict 1d: An area between Jackson Street and Minnesota Street from the southeast side of Columbus Avenue, and its geometric extension, to the southeast side of 12th Street. Maximum height is 864.1 feet above sea level, 170 feet above St. Paul datum. Should the part of Minnesota Street in this subdistrict be vacated, the building height restriction in its right-of-way shall be an elevation of 831.1 feet, 137 feet above St. Paul datum.

Subp. 3. **Height district 2.** Maximum height in height district 2 is established as 966.0 feet above sea level. Boundaries are as described in the map in subpart 6.

Subp. 4. **Height district 3a.** No building shall be constructed in height district 3a:

A. to a height greater than 944.0 feet above sea level; and

B. with a floor area ratio greater than 5.0. Boundaries for this district are described in the map in subpart 6.

Subp. 5. **Height district 3b.** No building shall be constructed in height district 3b with a floor area ratio greater than 5.0. Boundaries for this district are described in the map in subpart 6.

Subp. 6. Map of height districts in Capitol area.

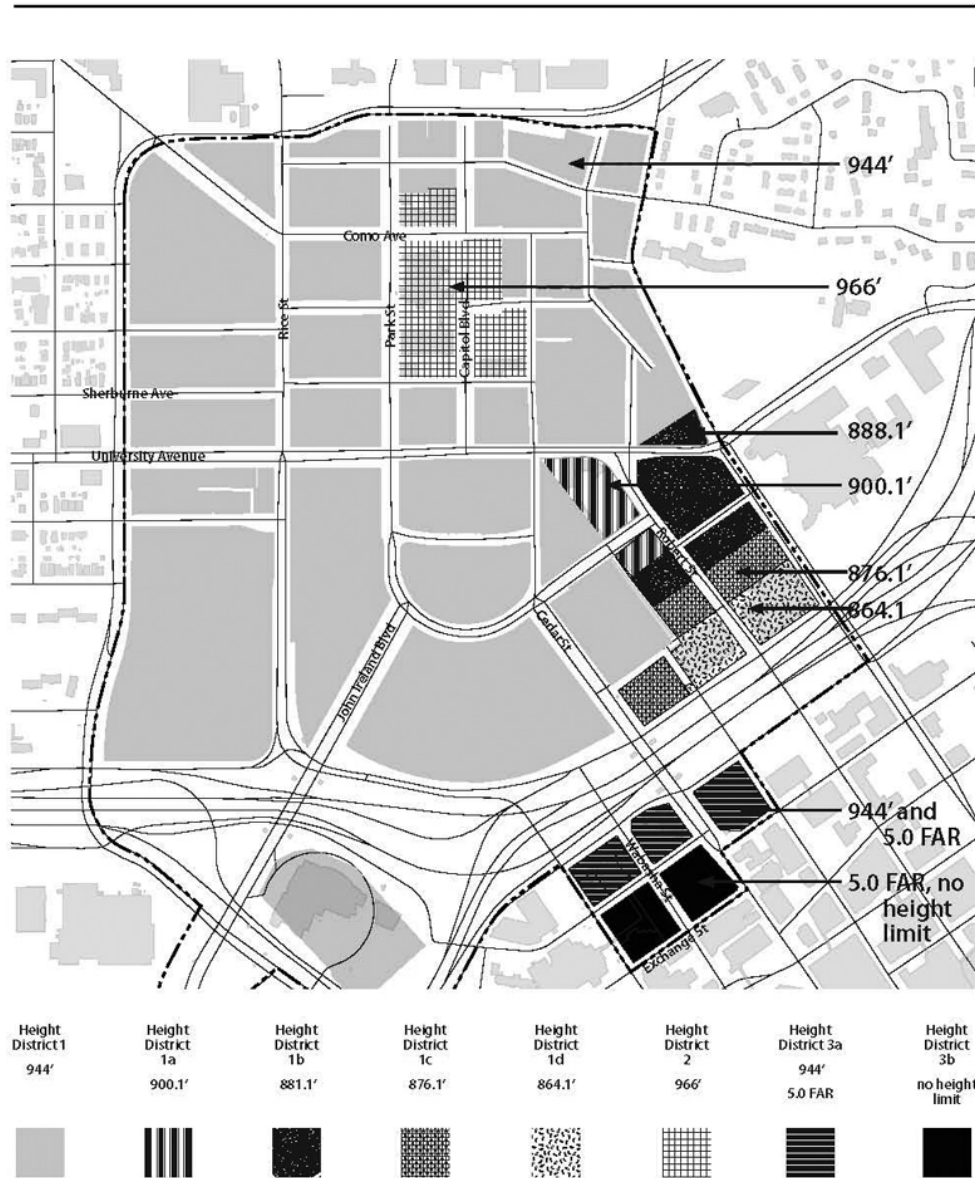

Statutory Authority: *MS s 15B.06*

History: *34 SR 900*

Published Electronically: *January 15, 2010*

2400.2400 FRONTAGE MAP.

Subpart 1. **Intent.** The intent of this part is to ensure that buildings relate to the public realm and to adjacent buildings in a manner consistent with the statutory purposes of the board as stated in Minnesota Statutes, section 15B.01, and the goals of the comprehensive plan.

Subp. 2. **Requirement.** The frontage map in subpart 3 establishes frontage types that are independent of use and height districts. "Frontage," as used in this chapter, means both the setback between the building façade and the front lot line and to the height and disposition of the building façade. In the case of buildings that abut more than one street, frontage requirements apply within each setback from a street as shown in subpart 3.

Subp. 3. **Frontage map.**



Subp. 4. **Capitol mall frontage.** Capitol mall frontage type requires a building a minimum of three stories in height, set back a minimum of 30 feet and a maximum of 40 feet from the lot line. This frontage type is intended to achieve the highest standard of architectural quality for buildings fronting the Capitol mall, as shown in the standards in part 2400.2405.

Subp. 5. **Capitol view frontage.** In the Capitol view frontage type, buildings must be set back a maximum of five feet from the lot line for at least 75 percent of their length. Buildings must be a minimum of two stories in height. In order to preserve significant views of the Capitol Building from University Avenue, any portion of the façade above two stories in height must be stepped back at least 30 feet behind the front plane of the building façade.

Subp. 6. **Civic frontage.** In the civic frontage type, buildings must be set back a minimum of five feet and a maximum of 15 feet from the front lot line for at least 85 percent of their length and must be a minimum of three stories in height. Where a new building is adjacent to existing buildings, it must maintain the average setback of those buildings.

Subp. 7. **Flexible frontage.** In the flexible frontage type, setback from the front lot line depends on building type and location. Residential buildings must be set back a minimum of 15 feet and a maximum of 25 feet, or the average of the block face, if developed. Nonresidential or mixed-use buildings must be set back between zero and 25 feet from the front lot line, but must not exceed the average block face setback. Buildings at corner locations must be located within five feet of the front lot line on either street for a distance of 30 feet from the corner.

Subp. 8. **Residential frontage.** In the residential frontage type, residential buildings must be set back a minimum of 15 feet and a maximum of 25 feet, or the average of the block face, where built out. Nonresidential buildings, where present, must be set back between zero and 25 feet from the front lot line, but must not exceed the average block face setback.

Statutory Authority: *MS s 15B.06*

History: *34 SR 900*

Published Electronically: *January 15, 2010*

2400.2405 MIXED AND NONRESIDENTIAL DESIGN STANDARDS FOR FRONTAGE TYPES.

The following mixed and nonresidential design standards apply to the Capitol mall, Capitol view, civic, and flexible frontage types as shown in the table in this part. An "S" in the table means that the design standard is mandatory, unless the applicant can demonstrate to the board that there are circumstances unique to the property that make compliance impractical or unreasonable. A "G" in the table means that the design standard is recommended as a guideline. Design standards for residential frontage areas are included in part 2400.2410.

Capitol Mall	Capitol View	Civic	Flexible
-----------------	-----------------	-------	----------

Building must be faced with cut stone, terra cotta, cast stone, or other materials of similar aesthetics and durability	S			
Building must be faced with cut stone or other natural materials, or with brick, split-faced block, or similar masonry materials		S	S	G
Roofs must be defined with a discernible cornice line that matches or is compatible with the cornice lines of adjacent buildings	S	G	S	G
Pitched roofs must be clad with highly durable fire-resistant materials such as standing seam metal, slate, ceramic, or composite tiles	S			
Use of green roofs for reductions in building energy consumption is strongly encouraged	G	G	G	G
Freestanding signs on poles or pylons are prohibited within frontage setback areas	S	S	S	S
Mechanical and electrical equipment such as transformers, air conditioning and heating units, communications antennae, and similar elements must not be visible from any point within the frontage setback area	S	S	S	S
New vehicular access points are prohibited from streets parallel to the designated frontage. Access and egress must be from streets other than those designated	S	S		
Landscaping within the frontage setback shall include a double row of canopy trees meeting the requirements of part 2400.2630	G	G		
Continuity of walls: building facades, fences, and landscape masses must contribute to the spatial definition of the frontage and form cohesive walls of enclosure along the street	S	G	G	G
Compatibility with visually related buildings, features, and places. The following building and site elements must be designed to be visually compatible with the	S	G	G	G

corresponding elements of those buildings, features, and places that meet the standards of this chapter and to which the building is visually related:

Proportion and dimensions of the building's front façade: the relationship of width of the building to height of the front elevation

Proportion of openings: the relationship of width of the windows to height of the windows

Rhythm of solids to voids: the relationship of solids to voids in the building's front façade

Rhythm of spacing of buildings: the relationship of a building to the open space between it and adjoining buildings

Rhythm of entrance and porch projections: the relationship of entrances and porch projections to sidewalks

Relationship of materials, texture, and color of building façades

Roof shapes

Scale of building: the size and mass of a building in relation to open spaces

Front elevation: the place and orientation of the front elevation of a building, including the shape and composition of its architectural elements

Landscape design: planted areas, plant materials, grading, pedestrian walks and areas, and other landscape elements

Statutory Authority: *MS s 15B.06*

History: *34 SR 900*

Published Electronically: *January 15, 2010*

2400.2410 RESIDENTIAL DESIGN STANDARDS.

A. Building fronts must be oriented to the primary abutting street.

B. Primary entrances to ground floor dwellings must be accessed directly from and face the street.

Fronts and Entrances Oriented to the Street



C. Secondary access may be from the side or rear, or, for multifamily buildings, through an interior stairway or elevator and corridor.

D. Where an alley is present, parking must be accessed through the alley.

E. Where no alley is present, parking must be accessed from a side street, if a corner lot, or a driveway to a rear yard or garage.

Garage Access from Side Street



F. In order to avoid the monotonous and pedestrian-unfriendly appearance of facades dominated by garage doors, any attached garage door parallel to a primary street may occupy no more than 50 percent of the width of that building façade, measured at grade. The portion of the

façade that contains the garage door must be recessed at least eight feet behind the remainder of the façade.

G. Usable outdoor space must be provided for each dwelling, to the rear or side of the principal building, with a rectangular shape and a minimum dimension of eight feet. Usable outdoor space may not be paved. Usable outdoor space for multifamily, townhouse, and carriage house dwellings may be combined and shared by multiple dwelling units.

H. Front yards must be landscaped. Landscaping may consist of trees, shrubs, or groundcovers, in combination with low fences or walls.

Landscaped Front Yards



I. The proportion, size, rhythm, and detailing of windows and doors in new construction must be compatible with that of adjacent buildings, but need not replicate them exactly.

J. Open porches and balconies are encouraged on building fronts.

Open porches



K. Building facades greater than 40 feet in length must be divided into smaller increments of 20 feet or less by means of divisions or breaks in materials, entry placement, window bays, or other architectural details.

Longer Buildings Articulated into Smaller Increments



Statutory Authority: *MS s 15B.06*

History: *34 SR 900*

Published Electronically: *January 15, 2010*

2400.2500 EXAMPLES OF BUILDING TYPES.

Subpart 1. **Intent.** The intent of this part is to establish design parameters for specific building types, regardless of what zoning district in which the buildings are located, and to encourage new building design that respects its context.

Subp. 2. **Scope.** This part provides examples of typical building types that are appropriate for the various zoning districts in the Capitol area. Other building types are acceptable upon approval by the zoning administrator, provided that they meet the lot, height, and frontage requirements and design standards of this chapter.

Subp. 3. **One-family building.** A one-family building is a single-family dwelling with yards on all sides. One-family buildings in the Capitol area are designed to fit on relatively narrow lots with the longest building dimension perpendicular to the street, with an attached or detached garage.

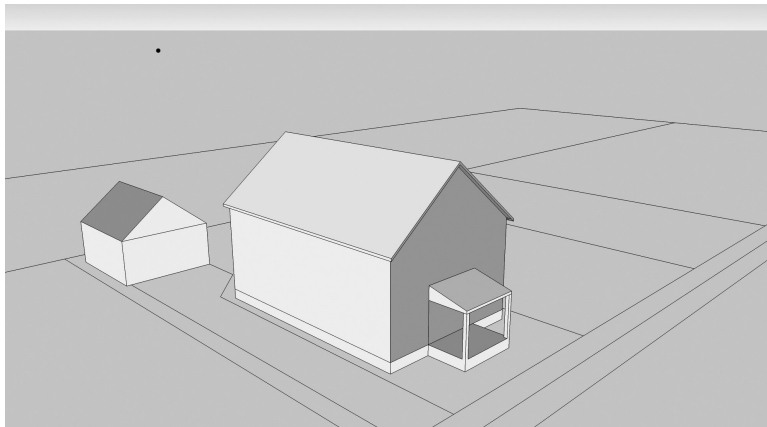

Subp. 4. **Duplex.** A duplex is a two-family building containing two dwelling units that are vertically stacked one above the other, with a separate entrance to each unit.

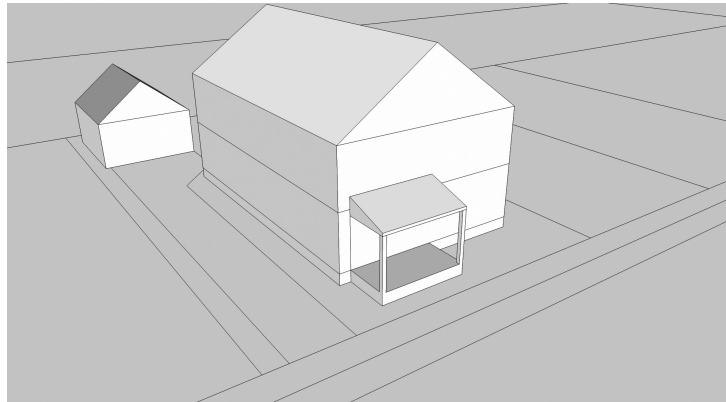

Subp. 5. **Twin.** A twin is a two-family building containing two attached dwelling units that share a common side wall and that are usually on separate lots, with the common wall at the lot line.

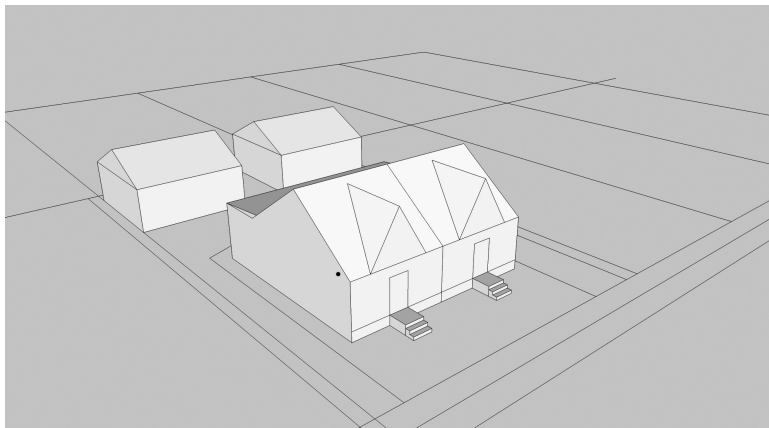



Subp. 6. **Townhouse.** A townhouse is a dwelling unit within a linear group of horizontally attached dwellings, each having a private entrance and totally exposed front and rear walls to be used for access, light, and ventilation.

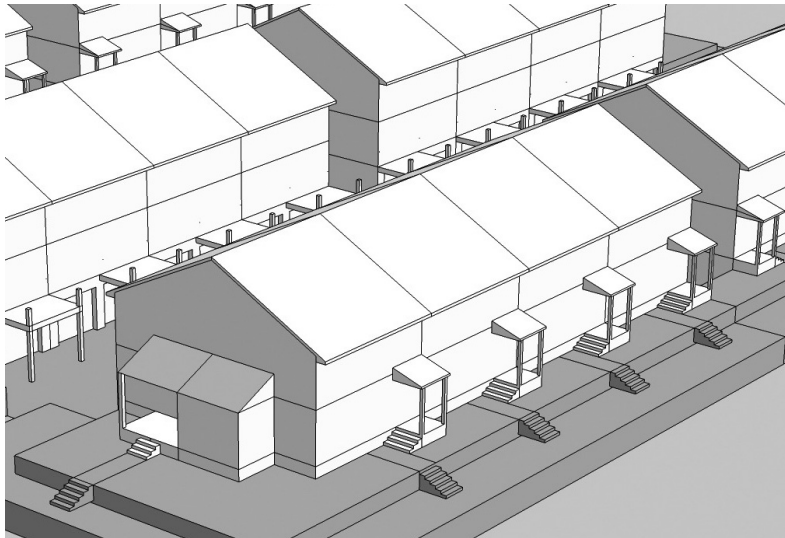



Subp. 7. **Small apartment; mansion building.** A small apartment, mansion building is a multistory multifamily building designed to resemble a large single-family building, typically with a pitched roof and central entrance oriented to the primary abutting street.

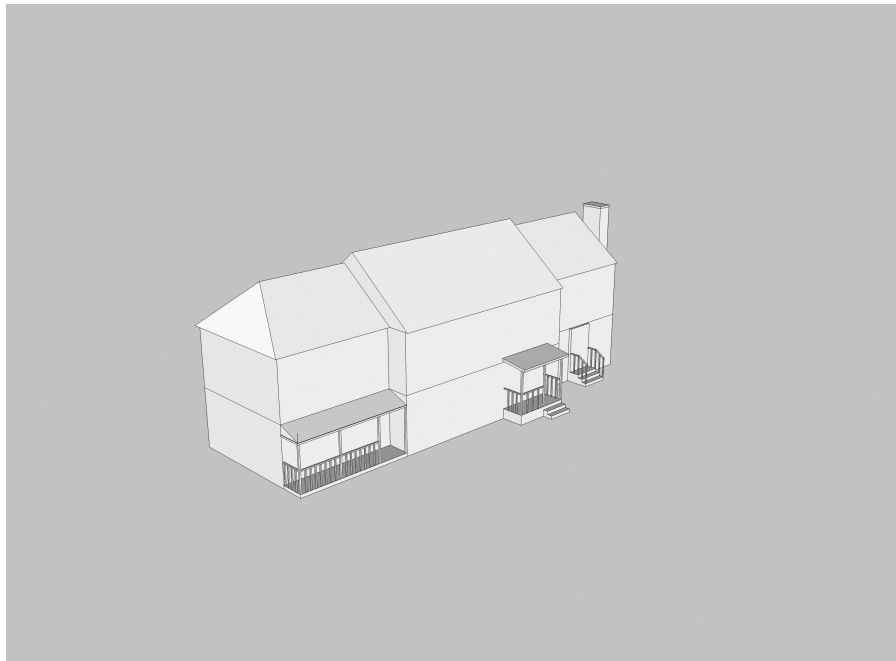



Subp. 8. **Large apartment building, stacked flats.** A large apartment building, stacked flats is a multistory building with combined entrances, stairways, and elevators and is composed of single- or two-level occupant spaces stacked on top of each other, typically accessed from a central corridor.

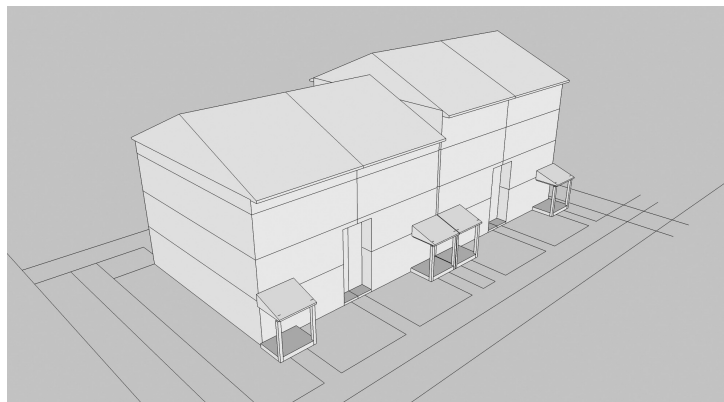

Subp. 9. **Courtyard apartment building.** A courtyard apartment building is a multistory building designed around an open courtyard abutting the primary street, surrounded by building walls on three sides.

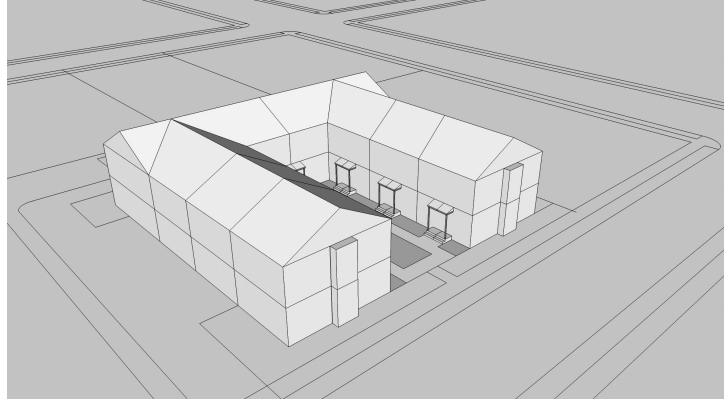

Subp. 10. **Carriage house building.** A carriage house building is an accessory dwelling unit located above an attached garage, or a group of attached dwelling units located above a series of attached garages.

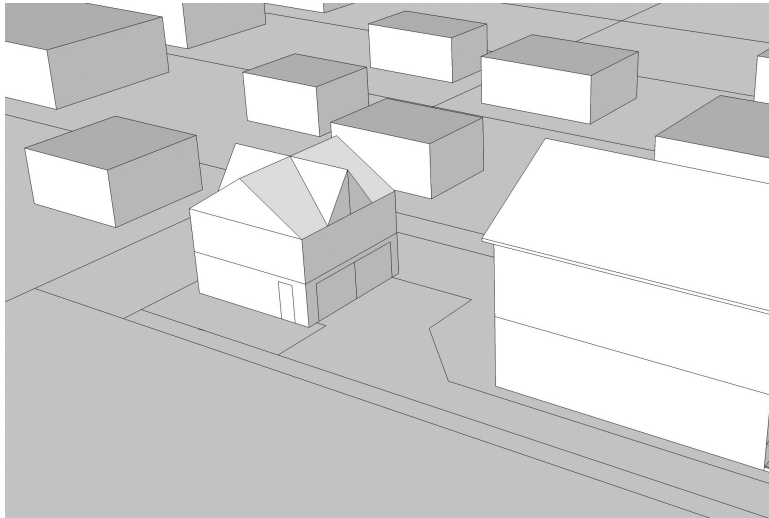

Subp. 11. **Civic building.** A civic building is a building type with classical proportions and high quality materials on all sides, predominantly in office use. Civic buildings used for state functions in the Capitol area are planned with the active involvement of the board and other stakeholders.

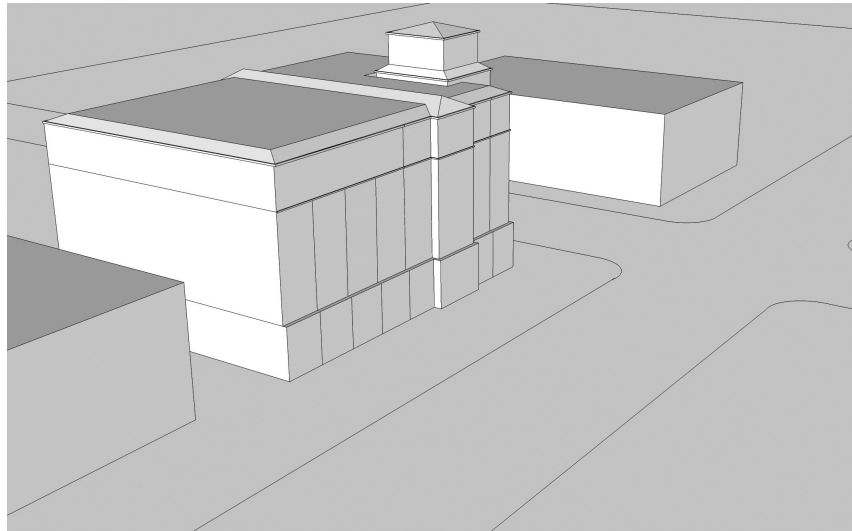

Subp. 12. **Commercial block building.** A commercial block building is a multistory building that is designed to support a mix of commercial or office uses on the ground floor with office, studio, or residential units above. Buildings are typically designed with storefront or arcade frontages at ground floor.

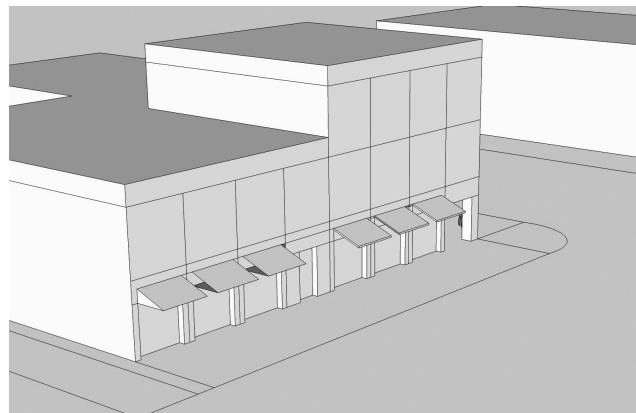



Subp. 13. **Parking building.** A parking building is a multistory building specifically designed for temporary parking of automobiles, which may also include ground floor storefronts and upper-level office space.

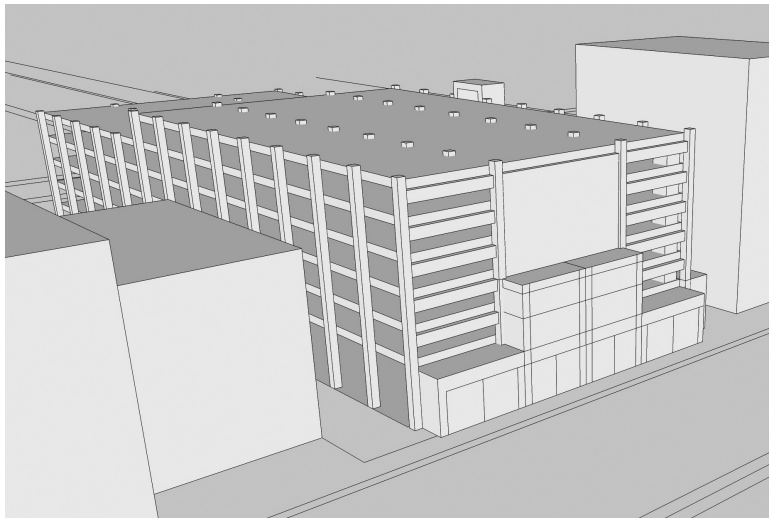



Subp. 14. **Live-work building.** A live-work building is similar to a townhouse in scale and detailing, but with a ground floor designed for small commercial, office, and service establishments, often with storefront detailing. Live-work buildings are generally placed at or close to the sidewalk, although a forecourt or patio design may be used to allow for outdoor seating space.

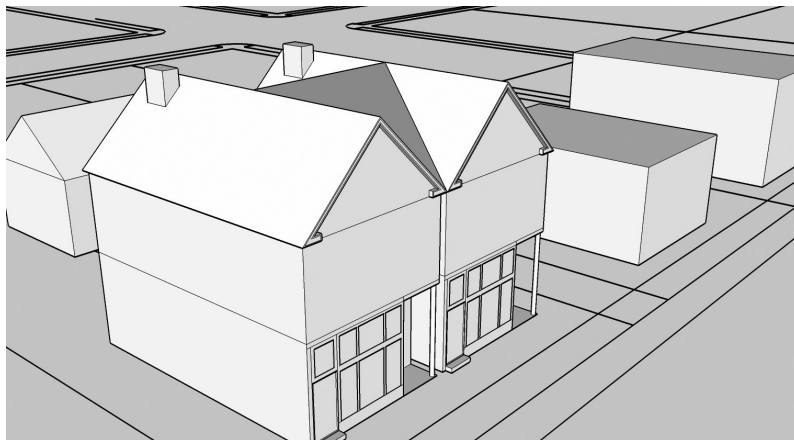



Subp. 15. **Liner building.** A liner building is a specialized building designed to conceal an area such as a parking lot or loading dock. While liner buildings may include commercial or residential uses, their limited depth makes them more disposed to residential use. Liner buildings may have a small common front yard, but do not include individual private outdoor spaces.

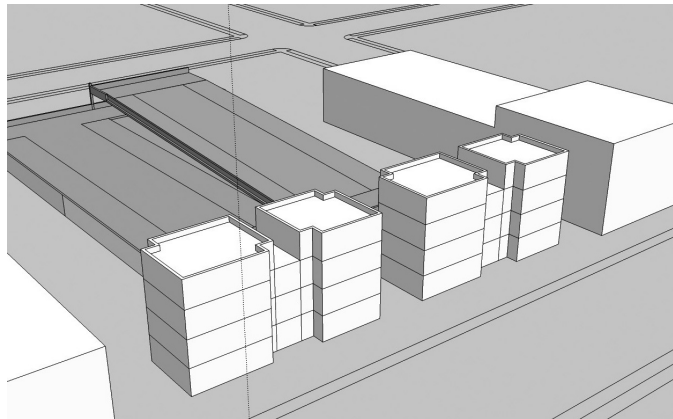



Subp. 16. **Podium building.** A podium building is a multistory mixed-use building in which the upper stories are stepped back from a lower base to provide outdoor terraces, to avoid excessive shadowing of streets or public spaces, or to preserve important views.

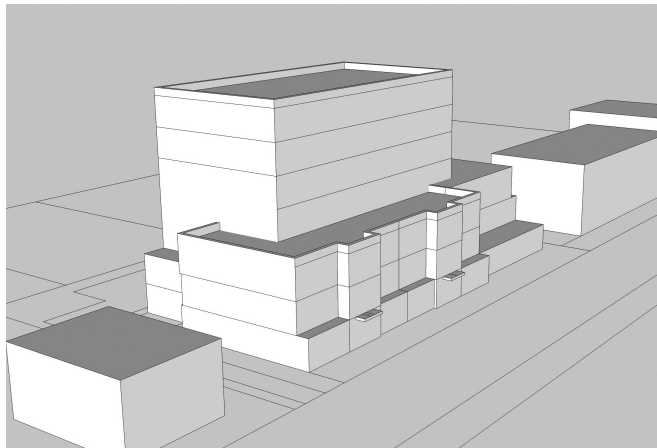



Subp. 17. **Freestanding workplace.** A freestanding workplace is a variable multistory building type designed to accommodate primarily office functions and limited retail services. A principal entrance is generally oriented to the primary abutting street. Building forms are flexible.

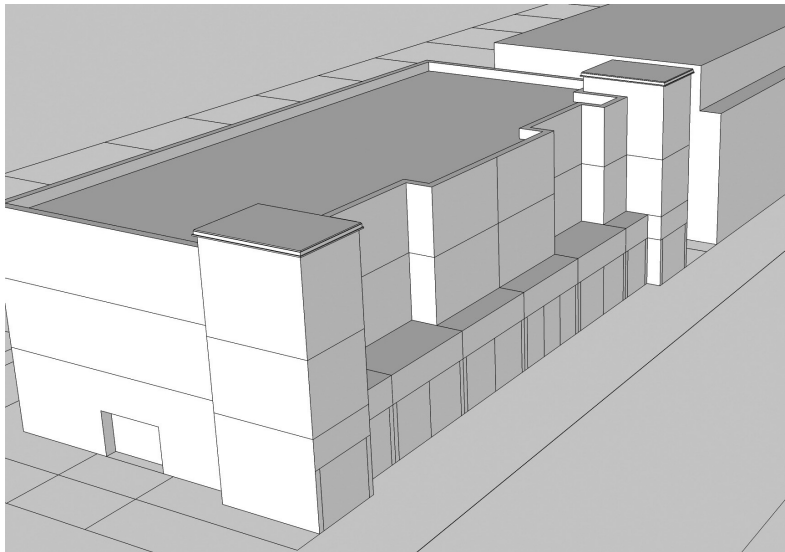



Statutory Authority: *MS s 15B.06*

History: *34 SR 900*

Published Electronically: *January 15, 2010*

2400.2600 SCOPE.

Parts 2400.2600 to 2400.2635 establish standards that apply throughout all or a portion of the Capitol area, including standards for accessory buildings and structures, landscaping, and lighting.

Statutory Authority: *MS s 15B.06*

History: *34 SR 900*

Published Electronically: *January 15, 2010*

2400.2605 ACCESSORY BUILDINGS.

Accessory buildings in all zoning districts must comply with the following standards:

A. An accessory building attached to a principal building, such as an attached garage, must comply with all the setback and height requirements applicable to the principal building.

B. Accessory buildings on a zoning lot may occupy up to 35 percent of the rear yard area. The total ground floor area of all accessory buildings must not exceed 1,000 square feet, and shall not exceed the ground floor area of the principal building.

C. A maximum of two accessory buildings is permitted on any zoning lot.

D. Buildings accessory to residential uses must be set back at least three feet from all interior lot lines and one foot from any lot line adjoining an alley. Accessory buildings on corner lots must be set back the same distance as the principal building from the street side lot line.

E. Buildings accessory to residential uses, with the exception of accessory dwelling units, shall not exceed one story or 14 feet in height.

Statutory Authority: *MS s 15B.06*

History: *34 SR 900*

Published Electronically: *January 15, 2010*

2400.2610 EXTERIOR LIGHTING.

A. All outdoor lighting in all use districts, including off-street parking facilities, must be shielded to reduce glare and must be so arranged as to reflect lights away from all adjacent residential districts or adjacent residences in such a way as not to exceed three footcandles measured at the residence district boundary.

B. All lighting used for the external illumination of buildings must be placed and shielded so as not to interfere with the vision of persons on adjacent highways or adjacent property.

C. Illumination of signs must be directed or shaded downward so as not to interfere with the vision of persons on adjacent highways or adjacent property.

D. Illumination of signs and any other outdoor feature must not be of a flashing, moving, or intermittent type. Illumination must be maintained stationary and constant in intensity and color at all times when in use.

Statutory Authority: *MS s 15B.06*

History: *34 SR 900*

Published Electronically: *January 15, 2010*

2400.2615 ENCROACHMENTS INTO REQUIRED YARDS.

The following structures or features are permitted to extend into or be located in required yards.

A. Entranceway structures, including walls, columns, and gates marking entrances to housing developments, may be located in a required yard if in compliance with all applicable city and state codes.

B. An open covered porch may project up to ten feet into a required front yard.

C. An open and uncovered deck may project up to ten feet into a required rear yard, provided the walking surface of the deck is not higher than eight feet above the adjacent grade.

D. An uncovered deck, paved terrace, or patio not exceeding two feet in height above the adjacent grade is considered landscaping and is not subject to setback or lot coverage requirements.

E. Architectural features such as overhangs, decorative details, and bay windows may extend or project into a required side yard not more than two inches for each one foot of width of the side yard, and may extend or project into a required front yard or rear yard not more than three feet.

F. Accessible ramps for a person with a mobility impairment are exempted and may project into all required yards.

G. Chimneys and fireplaces may project one foot into a required yard.

H. Air conditioning condensers may be located in required side and rear yards.

I. Satellite dish antenna and amateur radio antennas may be located in required side and rear yards, sited in locations that will minimize visibility from the street according to part 2400.2740.

Statutory Authority: *MS s 15B.06*

History: *34 SR 900; L 2013 c 62 s 32*

Published Electronically: *August 1, 2013*

2400.2620 CORNER CLEARANCE.

On a corner lot at two intersecting streets, no fence, wall, or other structure is allowed above a height of two feet from sidewalk grade in the triangular area of the lot included within ten feet of the corner along each lot line unless the structure is more than 80 percent open.

Statutory Authority: *MS s 15B.06*

History: *34 SR 900*

Published Electronically: *January 15, 2010*

2400.2625 STREET AND LANDSCAPE ELEMENTS.

Exterior structural elements such as benches, transit shelters, vending equipment, and similar elements in the public right-of-way must be approved by the board for both design and location.

Statutory Authority: *MS s 15B.06*

History: *34 SR 900*

Published Electronically: *January 15, 2010*

2400.2630 LANDSCAPE AND SCREENING STANDARDS.

Subpart 1. **Visual screens required.** The uses described in item A must be screened when abutting or adjacent to a residential district. Screening shall consist of an obscuring wall or obscuring fence, or other visual screen having a minimum height as required in item A. Whenever visual screens are required, the following standards apply.

A. Height regulations:

- (1) commercial or office uses, 4-1/2 feet;
- (2) hospital ambulance, delivery, and service areas, six feet;
- (3) utility buildings, stations, or substations, six feet; and
- (4) outdoor storage or service areas for nonresidential or multifamily uses, six feet.

B. Visual screens must be located completely within the lot line.

C. Visual screen locations must conform with front yard setback lines in residential districts.

D. Upon approval of the board, a required visual screen may be located on the opposite side of an alley right-of-way from the nonresidential zone, when mutually agreeable to affected property owners. Maintenance is the responsibility of the person required to erect the screen.

E. The land between the screen and the property line must be landscaped and maintained so that all plant materials are healthy and the area is free from refuse and debris.

F. Required visual screens must have no opening for pedestrians or vehicles except as shown on an approved site plan.

Subp. 2. **Landscaping of off-street parking lots.** All off-street parking lots of more than four parking spaces must be landscaped as follows:

A. A landscaped area at least eight feet in width must be provided between parking lots and the abutting street. Screening within this area must include a masonry wall, decorated fence, berm, or hedge that forms a screen between three and 3-1/2 feet in height, plus one deciduous shade tree planted every 40 feet on center.

B. A landscaped area at least six feet in width must be provided along side and rear lot lines between parking lots and abutting residential uses. Screening within this area must include a fence or wall at least 90 percent opaque, between 4-1/2 and six feet in height, plus at least one tree and five shrubs for every 50 lineal feet of property line.

C. Off-street parking lots larger than 50 spaces must include 300 square feet of landscaped islands for every 50 spaces over 50. Each landscaped island must be a minimum of ten feet in width and 300 square feet in area.

Subp. 3. **Landscaping of open areas.** The remainder of any landscaped area not occupied by trees or shrubs must be covered with turf grass, native grasses, or other perennial flowering plants, vines, shrubs, or trees.

Subp. 4. **Plant materials; standards and maintenance.** Plant materials used in visual screens, parking lot landscaping, or other applications must meet the following standards:

A. The genus and species of all plant materials must be identified on all plans submitted for permit approval.

B. The species, size, location, and spacing of plant materials must be appropriate for the purpose intended, and must be planted within 180 days from the date of issuance of a certificate of occupancy.

C. At the time of planting, minimum plant sizes are as follows: shade trees must be 1-1/2 inch caliper, ornamental trees must be six to eight feet overall height, conifers must be four to six feet overall height, and shrubs used for screening must be 15 to 18 inches overall height.

D. Wherever plant materials are used to satisfy a visual screen requirement, planting must be sufficiently dense to provide an unbroken visual barrier within a maximum of two growing seasons after the time of planting.

E. The owners are responsible for maintaining all landscaping in a healthy and growing condition and keeping it free from refuse and debris. Dead plant materials must be removed within a reasonable time and replaced during the normal planting seasons. Plant materials shall be warranted for a minimum of two years.

Statutory Authority: *MS s 15B.06*

History: *34 SR 900*

Published Electronically: *January 15, 2010*

2400.2635 STORM WATER MANAGEMENT STANDARDS.

A. For sites where more than one-quarter of an acre is affected by development, with the exception of state of Minnesota buildings and facilities, the standards of the city of St. Paul Public Works Department for storm water runoff for the site apply. Storm water management plans and calculations are required as part of building permit submittals.

B. All projects that occupy or disturb an area larger than one acre in size, with the exception of state of Minnesota buildings and facilities, are subject to the storm water management, erosion, sedimentation control, and other standards of the Capitol Region Watershed District.

Statutory Authority: *MS s 15B.06*

History: *34 SR 900*

Published Electronically: *January 15, 2010*

2400.2700 SCOPE.

Parts 2400.2700 to 2400.2740 establish standards applicable to particular land uses, including permitted and conditional uses, in one or more zoning districts. The standards apply within all zoning districts where the specified use is allowed, except where otherwise noted.

Statutory Authority: *MS s 15B.06*

History: *34 SR 900*

Published Electronically: *January 15, 2010*

2400.2705 STANDARDS FOR CIVIC AND INSTITUTIONAL USES.

Subpart 1. **Monuments, memorials, and commemorative works.** Monuments, memorials, and commemorative works structures must be approved for placement under Minnesota Statutes, section 15B.05, subdivision 3.

A. All commemorative works for the Capitol area must meet the following objectives:

(1) to preserve the integrity of the Capitol area;

- (2) to ensure that such works are appropriately designed, constructed, and located;
 - (3) to maintain the dignity of existing memorials;
 - (4) to ensure that the subject is of lasting significance to the people of the state;
 - (5) to reflect the diversity of the state's people and culture, yet not be partisan in nature;
- and
- (6) to provide an enriching experience that illuminates underlying values and broadens understanding of the state's heritage and culture.

B. The commemorative work must be consistent with and meet the conditions of the following board documents:

- (1) Comprehensive Plan for the State Capitol Area, 1998, as amended in 2009;
- (2) Specific Actions for Implementation of the Comprehensive Plan for the State Capitol Area, February 1998; and
- (3) Commemorative Works in the Capitol Area: A Framework for Initiation, Evaluation and Implementations of Commemorative Works in the Capitol Area, May 1993.

These documents are incorporated by reference and are available at the board's office and website and the State Law Library. They are not subject to frequent change.

Subp. 2. **G-2 District underground structures.** Underground structures in the G-2 District containing uses permitted in the G-1 District are permitted under the following conditions:

- A. the location and type of landscaping shall preserve and enhance the Capitol area;
- B. safeguards for erosion control shall be provided that include, but are not limited to, landscaping and seeding of topsoil;
- C. reasonable documentation satisfactory to the board that soil conditions will not cause damage to adjacent property shall be provided;
- D. vistas of the Capitol shall remain intact; and
- E. only aboveground uses that are essential to the operation of underground structures shall be permitted, including, but not limited to, ventilation shafts. These aboveground accessory uses shall in no way detract from the Capitol area.

Subp. 3. **Day care facilities.** Day care facilities must conform to all applicable state and city licensing standards for day care facilities. A fence at least 3-1/2 feet in height shall surround all play areas located in a front yard or adjacent to a public or private street.

Statutory Authority: *MS s 15B.06*

History: *34 SR 900*

Published Electronically: *September 6, 2018*

2400.2710 STANDARDS FOR RESIDENTIAL USES.

The standards for a carriage house dwelling are as follows:

A. The applicant must not reduce the number of existing off-street parking spaces on the property and must also provide one additional off-street parking space for the carriage house dwelling.

B. A site plan and a building plan must be submitted to the zoning administrator at the time of application. Carriage house dwellings are exceptions to the one main building per zoning lot requirement.

C. Carriage houses must employ materials, roof pitch, orientation, door and window placement and proportions, and other details compatible with those of the principal building.

Statutory Authority: *MS s 15B.06*

History: *34 SR 900*

Published Electronically: *January 15, 2010*

2400.2715 STANDARDS FOR CONGREGATE LIVING USES.

A. For nursing homes, boarding care homes, and assisted living facilities, the yard requirements for multiple family use in the district apply.

B. For community residential facilities licensed by the Department of Human Services, Department of Corrections, or Department of Health for 12 or fewer persons, rooming houses and boarding houses, transitional housing facilities, emergency housing facilities, and shelters for battered persons, the following apply:

(1) new facilities are allowed, provided that, in the board's determination, no more than one percent of the Capitol area's population already lives in any of these facilities;

(2) facilities must be located at least 1,320 radial feet from any other such facility;

(3) a minimum lot area of 5,000 square feet must be provided for the first two guest rooms and 1,000 square feet for each additional guest room;

(4) permission for conditional use applies only as long as the number of residents is not increased; its licensing, purpose, or location do not change; and other conditions of the permit are met; and

(5) a facility must not be located in a two-family or multifamily dwelling unless the facility occupies the entire structure.

Statutory Authority: *MS s 15B.06*

History: *34 SR 900*

Published Electronically: *January 15, 2010*

2400.2720 STANDARDS FOR MIXED COMMERCIAL-RESIDENTIAL USES.

A. Permitted home occupation uses are as follows:

(1) A home occupation may include offices, service establishments, or home crafts that are typically considered accessory to a dwelling unit. Home occupations may involve only limited retailing, by appointment only, associated with fine arts, crafts, or personal services.

(2) A home occupation must not involve the conduct of a general retail or wholesale business, a manufacturing business, a commercial food service requiring a license, or auto service or repair for any vehicles other than those registered to residents of the property or the owner of the property.

(3) A home occupation must be carried on wholly within the main building. A home occupation is not allowed in detached accessory buildings or garages.

(4) A home occupation must be conducted by residents living in the main building, and up to two additional employees.

(5) Additions to the dwelling for the primary purpose of conducting the home occupation must not exceed ten percent of the ground floor area of the dwelling.

(6) Service and teaching occupations must serve no more than one party per employee at a time and may not serve groups or classes.

(7) There may be no exterior storage of products or materials.

(8) Only one business vehicle no larger than a pickup truck or van may be parked on the property.

(9) The use must not adversely affect the residential character of the neighborhood due to noise, odor, smoke, dust, gas, heat, glare, vibration, electrical interference, traffic congestion, number of deliveries, hours of operation, or any other annoyance.

(10) A home occupation may have an identification sign no larger than two square feet in area, which shall not be located in a required yard.

B. The standards in item A for permitted home occupations apply for conditional uses of home occupations with the following exceptions:

(1) A commercial food service requiring a license may be allowed by conditional use.

(2) A home occupation may be allowed within a detached accessory building or garage by conditional use.

(3) A sign up to seven square feet in size may be allowed by conditional use.

C. Live-work unit uses are as follows:

(1) The work space component must be located on the first floor or basement of the building, with an entrance facing the primary abutting public street.

(2) The dwelling unit component must be located above or behind the work space, and maintain a separate entrance located on the front or side façade and accessible from the primary abutting public street.

(3) The office or business component of the unit may not exceed 30 percent of the total gross floor area of the unit.

(4) A total of two off-street parking spaces must be provided for a live-work unit, located to the rear of the unit, or underground, and enclosed.

(5) The size and nature of the work space must be limited so that the building type may be governed by residential building codes. An increase in size or intensity beyond the specified limit requires the building to be classified as a mixed-use building.

(6) The business component of the building may include offices, small service establishments, home crafts that are typically considered accessory to a dwelling unit, or limited retailing, by appointment only, associated with fine arts, crafts, or personal services. The business component must be limited to those uses otherwise permitted in the district that do not require a separation from residentially zoned or occupied property or other protected use. It may not include a wholesale business, a manufacturing business, a commercial food service requiring a license, a limousine business, or auto service or repair for any vehicles other than those registered to residents of the property.

Statutory Authority: *MS s 15B.06*

History: *34 SR 900*

Published Electronically: *January 15, 2010*

2400.2725 STANDARDS FOR PUBLIC SERVICE AND UTILITY USES.

Cellular telephone antenna use is permitted as follows:

A. A conditional use permit is required for cellular telephone antennas on a residential structure that is less than 60 feet high.

B. A conditional use permit is required for cellular telephone antennas on a freestanding pole, except for existing utility poles. Existing utility poles to which cellular telephone antennas are attached must be at least 60 feet high.

C. In the G-1, RM, and MX districts, antennas may not extend more than 15 feet above the structural height of the structure to which they are attached. In the MXD district, antennas may not extend more than 40 feet above the structural height of the structure to which they are attached.

D. For antennas proposed to be located on a residential structure less than 60 feet high or on a new freestanding pole, the applicant must demonstrate to the board that the proposed antennas cannot be accommodated on an existing freestanding pole, an existing residential structure at least 60 feet high, an existing institutional use structure, or a business building within a one-half mile radius of the proposed antennas due to one or more of the following reasons:

(1) The planned equipment would exceed the structural capacity of the existing pole or structure.

(2) The planned equipment would cause interference with other existing or planned equipment on the pole or structure.

(3) The planned equipment cannot be accommodated at a height necessary to function reasonably.

(4) The owner of the existing pole, structure, or building is unwilling to colocate an antenna.

E. Cellular telephone antennas to be located on a new freestanding pole are subject to the following standards and conditions:

(1) The freestanding pole must not exceed 75 feet in height, unless the applicant demonstrates that the surrounding topography, structures, or vegetation renders a 75-foot pole impractical. Freestanding poles may exceed the 75-foot height limit by 25 feet if the pole is designed to carry two antennas.

(2) Antennas may not be located in a required front or side yard and must be set back a distance equal to the height of the antenna plus ten feet from the nearest residential structure.

(3) The antennas must be designed where possible to blend into the surrounding environment through the use of color and camouflaging architectural treatment. Drawings or photographic perspectives showing the pole and antennas must be provided to the board to determine compliance with this provision.

(4) In the RM district, the pole must be on institutional use property at least one acre in area. In other districts, the zoning lot on which the pole is located must be within contiguous property at least one acre in area.

(5) A freestanding pole must be a monopole design.

F. Transmitting, receiving, and switching equipment must be housed within an existing structure whenever possible. If a new equipment building is necessary, it shall be permitted and regulated as an accessory building, and screened from view by landscaping where appropriate.

G. Cellular telephone antennas that are no longer used for cellular telephone service must be removed within one year of nonuse.

Statutory Authority: *MS s 15B.06*

History: *34 SR 900*

Published Electronically: *January 15, 2010*

2400.2730 STANDARDS FOR COMMERCIAL USES.

Subpart 1. **General retail.** For the purpose of this part, general retail includes, but is not limited to, the following uses:

- A. antiques and collectibles store;
- B. art gallery;
- C. bicycle sales and repair;
- D. book store, music store;
- E. clothing and accessories;
- F. drugstore, pharmacy;
- G. electronics sales and repair;
- H. florist;
- I. jewelry store;
- J. hardware store;
- K. newsstand, magazine sales;
- L. office supplies;
- M. pet store;
- N. photographic equipment, film developing;
- O. stationery store;
- P. picture framing; and
- Q. video store.

The use category may not include merchandise limited to adult use due to its sexual nature, alcohol for off-site consumption, guns, or other uses addressed as conditional uses under part 2400.2205.

Subp. 2. Outdoor display, storage, and sales.

A. Extensive outdoor display or sales areas that exceed ten percent of the main structure's area are not permitted under the general retail use category.

B. In the MX and MXD districts, outdoor storage or display of goods is not allowed except for the following:

- (1) outdoor dining accessory to restaurants and coffee shops;
- (2) incidental accessory structures at automotive service and repair establishments, such as donation drop-off boxes, ice machines, and soda machines;
- (3) automatic teller machines accessory to banks; and
- (4) periodic "sidewalk sales" as a temporary use.

Subp. 3. **General retail, office use, coffee shop, or service business.** In the RM district, the following conditions apply to general retail, office use, coffee shop, or service business uses:

A. The building must have been originally designed as a storefront or other nonresidential or mixed-use building, and must be located at a corner of two streets.

B. Traditional storefront features such as display windows must be preserved and restored.

C. Retail or office use may not exceed 800 square feet in gross floor area except by conditional use permit.

D. The building may also be used for residential uses permitted in the district, in addition to the retail use.

Subp. 4. **Dry cleaners or laundries.** Dry cleaners or laundries, including self-service laundries and dry cleaners, may serve no more than one retail outlet.

Subp. 5. **Outdoor sales.** Primary and accessory uses of outdoor sales must not lessen or impinge upon the off-street parking area or the off-street loading area, or impair pedestrian access or flow.

Subp. 6. **Restaurant, fast food.** Fast food restaurants must be incorporated into a multiuse retail center and shall not include a drive-through or drive-in facility.

Subp. 7. **Indoor recreation.** Indoor recreation, including bowling alley, billiard hall, amusement arcade, indoor archery range, indoor tennis court, indoor skating rink, or similar forms of indoor commercial recreation facilities, must be located at least 100 feet from any front, rear, or side yard of any residential lot in an adjacent residential district.

Subp. 8. **Automobiles.** Automobile sales or service center facilities must be fully enclosed and located in a multiuse retail center.

Statutory Authority: *MS s 15B.06*

History: *34 SR 900*

Published Electronically: *January 15, 2010*

2400.2735 STANDARDS FOR LIMITED PRODUCTION, PROCESSING, AND STORAGE USES.

For the purpose of this part, limited production and processing facilities include:

- A. apparel and other finished products made from fabrics;
- B. copying and printing services;
- C. computers and accessories, including circuit boards and software;
- D. electronic components, assemblies, and accessories;
- E. film, video, and audio production;

F. food and beverage products, except no live slaughter, grain milling, cereal, vegetable oil, or vinegar processing;

G. jewelry, watches, and clocks;

H. milk, ice cream, and confections;

I. musical instruments;

J. novelty items, pens, pencils, and buttons;

K. precision dental, medical, and optical goods;

L. signs, including electric and neon signs and advertising displays;

M. toys;

N. wood crafting and carving; and

O. wood furniture and upholstery.

All goods must be sold at retail only on the premises where they are processed or manufactured.

Statutory Authority: *MS s 15B.06*

History: *34 SR 900*

Published Electronically: *January 15, 2010*

2400.2740 STANDARDS FOR ACCESSORY USES.

A. Antenna, amateur radio, or satellite dish standards are as follows:

(1) Antennas may not exceed one meter in diameter in the RM district and two meters in diameter in all other districts.

(2) Antennas may not be located in any required front yard, nor may they be located between a principal building and a required front yard.

(3) Only one freestanding tower or antenna is allowed per residential zoning lot.

(4) Building-mounted antennas must be placed in the least visible locations as viewed from any adjacent street.

(5) Ground-level antennas must be screened with landscaping or with building walls on all sides of the antenna in a manner in which growth of the landscape elements will not interfere with the transmit-receive window.

B. Outside storage of construction materials and equipment must be removed within ten days after construction is complete.

C. Solar energy systems or devices may be placed within required rear or side yards or attached to the rear or side of a building. Attached equipment may not exceed building height limits.

D. Wind energy conversion systems or devices may not exceed 100 kilowatts in rated capacity and must meet the following standards:

- (1) building-mounted wind energy conversion systems may not exceed 25 feet in height;
- (2) building-mounted wind energy conversion systems are prohibited on residential structures less than four stories in height and structures accessory to residential uses;
- (3) building-mounted wind energy conversion systems must be set back at least ten feet from the front, side, and rear walls of the structure upon which they are mounted;
- (4) building-mounted wind energy conversion systems on structures over four stories in height must be installed above the fourth story;
- (5) the structure upon which the proposed wind energy conversion system is to be mounted must have the structural integrity to carry the weight and wind loads of the wind energy conversion system and have minimal vibration impacts on the structure; and
- (6) freestanding wind energy conversion systems are prohibited in the Capitol area.

Statutory Authority: *MS s 15B.06*

History: *34 SR 900*

Published Electronically: *January 15, 2010*

2400.2800 GENERAL PARKING REQUIREMENTS.

Off-street parking spaces must be provided in all zoning districts, except for the MXD district, at the time of erection or enlargement of the principal building or structure according to parts 2400.2800 to 2400.2835.

Statutory Authority: *MS s 15B.06*

History: *34 SR 900*

Published Electronically: *January 15, 2010*

2400.2805 LOCATION OF OFF-STREET PARKING.

Subpart 1. **Nonresidential or mixed use.** Off-street parking for nonresidential or mixed uses must be located on the same lot or within the same district and within 1,000 feet of the building it is intended to serve, measured from the nearest point of the building to the nearest point of the off-street parking lot.

Subp. 2. **Capitol campus.** The Capitol campus is treated as a single parking district for the purpose of providing employee and visitor parking and transportation facilities. Therefore, parking for state buildings and facilities is not subject to the 1,000 foot requirement under subpart 1.

Subp. 3. **Residential use.** Off-street parking for residential uses must be located on the same lot as the dwelling it is intended to serve. Parking may be located within a garage or on a paved

surface outside of the required front yard, meeting the dimensional and setback requirements of the zoning district where the use is located.

Statutory Authority: *MS s 15B.06*

History: *34 SR 900*

Published Electronically: *January 15, 2010*

2400.2810 REDUCTION BELOW REQUIRED MINIMUM PROHIBITED.

No area used or designated as off-street parking may be reduced in size below the minimum parking requirements in parts 2400.2800 to 2400.2835, except by conditional use permit under part 2400.3155.

Statutory Authority: *MS s 15B.06*

History: *34 SR 900*

Published Electronically: *January 15, 2010*

2400.2815 SHARED OFF-STREET PARKING FACILITIES.

Two or more buildings or uses may jointly provide the required off-street parking. Where the peak hours of the buildings or uses providing joint parking facilities are nonconcurrent and lend themselves to shared use, the zoning administrator may, upon written application, reduce the number of parking spaces otherwise required. If the peak hours of use change so that they are concurrent, the number of required parking spaces shall revert to the requirements for the several individual uses computed separately.

Building owners with shared parking permits must submit an annual statement to the zoning administrator that verifies the nonconcurrent peak parking hours of the buildings involved with the shared parking permit and lists the uses within each building.

Statutory Authority: *MS s 15B.06*

History: *34 SR 900*

Published Electronically: *January 15, 2010*

2400.2820 SPACES REQUIRED.

Off-street parking spaces shall be provided according to the following schedule:

LAND USE	MINIMUM NUMBER OF PARKING SPACES
Civic and Institutional Uses:	
State offices and other facilities	Three spaces per 1,000 square feet GFA
Other public buildings and uses	Three spaces per 1,000 square feet GFA
Day care center	One space per ten children

Place of worship	One space per five seats or ten feet of pews in central space
Residence associated with place of worship	1.0 space per three occupancy units
School, K-12	1.0 space per teacher or administrator
Trade school, business school, or art school	One space per each two employees and staff members and one per each two full-time students or three part-time students
Hospital or clinic	One space per two beds

Residential Uses:

One-family dwelling	1.5 spaces per unit
Two-family and townhouse dwellings	1.5 spaces per unit
Multifamily dwelling	1.0 space per unit
Carriage house dwelling	1.0 space per unit
Housing for the elderly	1.0 space per four residents
Community residential facility	1.0 space per four bedrooms

Mixed Commercial-Residential Uses:

Live-work unit	Two spaces
Mixed commercial-residential use	One space per dwelling unit plus nonresidential spaces as specified in this part for the nonresidential use

Commercial Uses:

Administrative or professional office, medical laboratory	Three spaces per 1,000 square feet GFA
Clinic, medical or dental, veterinary clinic	Four spaces per 1,000 square feet GFA
Bank, credit union	Four spaces per 1,000 square feet GFA
Laundromat	Three spaces per 1,000 square feet GFA
Mortuary, funeral home	Six spaces per 1,000 square feet GFA

Restaurant, coffee shop (may include wine/beer service), tea room, deli	Six spaces per 1,000 square feet GFA
Restaurant serving alcohol*, bar, tavern	Eight spaces per 1,000 square feet GFA
Service business	Three spaces per 1,000 square feet GFA
Bed and breakfast residence	One space per two guest rooms in addition to residential requirement
Hotel, inn, motel	One space per occupancy unit
Indoor recreation	Three spaces per 1,000 square feet GFA
Theater, assembly hall (completely enclosed)	One space per four seats
Auto service station, repair station	One space per service stall, rack, or pit
Furniture and appliance, household equipment sales, showrooms	One space per 1,000 square feet GFA
Retail or service use not otherwise specified	Three spaces per 1,000 square feet GFA

*Establishments serving on-sale intoxicating liquor

Statutory Authority: *MS s 15B.06*

History: *34 SR 900*

Published Electronically: *January 15, 2010*

2400.2825 CONSTRUCTION AND DESIGN OF OFF-STREET PARKING SPACES.

A. Off-street parking construction requires a zoning permit from the board and a building permit from the city. An application and site plan are required for board review.

B. Plans for the layout of off-street parking facilities must meet the following minimum requirements:

Parking Pattern	Maneuvering Lane Width	Parking Space Width	Parking Space Length	Total Width of One Tier of Space Plus Maneuvering Lane	Total Width of Two Tiers of Spaces Plus Maneuvering Lane
0 degrees, parallel parking	12 feet	8 feet	21 feet	20 feet	28 feet

30 degrees to 53 degrees	12 feet	8 feet, 6 inches	18 feet	30 feet, 6 inches	49 feet
54 degrees to 74 degrees	15 feet	8 feet, 6 inches	18 feet	35 feet	55 feet
75 degrees to 90 degrees	20 feet	8 feet, 6 inches	18 feet	38 feet	56 feet

C. Parking areas may designate up to 50 percent of their area for compact cars only; the minimum layout dimensions for each compact car space may be reduced to eight feet in width and 16 feet in length.

D. All spaces must have adequate access by means of maneuvering lanes. Backing directly onto a street is prohibited.

E. All vehicles must have adequate ingress and egress to the parking lot by means of clearly limited and defined drives.

F. All maneuvering lane widths must permit one-way traffic movement, except that the 90 degree pattern must permit two-way movement.

G. Each entrance and exit to and from any off-street parking lot located in an area zoned for other than residential use must be at least 25 feet distant from any adjacent property located in any residential district.

H. The off-street parking area must be provided with a continuous and obscuring wall or visual screen as required in part 2400.2630.

I. Wheel stops are required for each parking space located next to walkways, doors, slopes, or other places where safety may be an issue in lots of three or more car capacity.

J. The entire parking area, including parking spaces and maneuvering lanes, required under this part must be provided with a durable, dustless surfacing according to specifications approved by the board. The parking area must be surfaced within one year of the date the permit is issued.

K. Off-street parking areas must be drained to dispose of all accumulated surface water without drainage of water onto adjacent property or toward buildings.

L. All lighting used to illuminate any off-street parking area must be directed onto the parking area.

Statutory Authority: *MS s 15B.06*

History: *34 SR 900*

Published Electronically: *January 15, 2010*

2400.2830 BICYCLE PARKING REQUIREMENTS.

Off-street parking facilities must include a minimum of one secure bicycle parking space for every 20 motor vehicle parking spaces, with a minimum of two bicycle parking spaces. Each inverted U-shaped bicycle rack counts as two bicycle parking spaces.

Bicycle parking facilities must meet the following requirements:

A. Off-site bicycle parking facilities may be provided for state offices and other state facilities. Off-site parking facilities must be designed with the same degree of monitoring and weather protection as off-site automobile parking facilities.

B. On-site bicycle parking facilities must be at least as close to the main entrance of the primary use as the most convenient one-third of the automobile parking.

C. On-site outdoor bicycle parking must be visible from the public right-of-way or from within the building. With permission of the city engineer, bicycle parking may be located in the public right-of-way.

D. Bicycle parking may be provided within a building, provided that the location is easily accessible and signed for bicycles.

E. Where motor vehicle parking spaces are monitored, covered, or weather-protected, bicycle parking spaces must be provided on the same basis.

F. For purposes of this part, a secure bicycle parking space must include a bicycle rack that permits the locking of the bicycle frame and one wheel to the rack, and supports the bicycle in a stable position without damage to the wheels, frame, or components.

G. Bicycle parking facilities must be anchored to prevent easy removal.

Statutory Authority: *MS s 15B.06*

History: *34 SR 900*

Published Electronically: *January 15, 2010*

2400.2835 LOADING SPACE REQUIREMENTS.

On any property where vehicle, materials, or merchandise are received or distributed, an adequate loading and unloading area must be provided.

A. Each off-street loading space must not be located in any yard adjoining any residential use.

B. Off-street loading areas with more than two spaces must be screened from the public right-of-way with landscape material, an obscuring fence, walls, or a combination of these.

C. Each loading space shall be at least ten feet by 50 feet, with a clearance of at least 14 feet in height.

D. Space must be provided within the off-street loading area so that any maneuvering back into or out of a loading space can be conducted outside of any public right-of-way.

E. Loading dock approaches must be provided with a pavement having a permanent, durable, and dustless surface. All spaces must be provided in at least the following ratio:

Usable Floor Area (Square Feet)	Number of Loading Spaces Required
Zero to 1,400	None
1,401 to 20,000	One space
20,001 to 100,000	One space for each 20,000 square feet or fraction thereof
100,001 and over	Five spaces

Statutory Authority: *MS s 15B.06*

History: *34 SR 900*

Published Electronically: *January 15, 2010*

2400.2900 INTENT.

Parts 2400.2900 to 2400.2940 regulate outdoor advertising and outdoor signs of all types in the Capitol area. The intent is to control signs; to reduce hazards and traffic accidents; to relieve pedestrian and traffic congestion; to protect and provide more open space; to preserve and enhance the dignity, beauty, and architectural integrity of the Capitol area; and to ensure that all signs are suitably integrated with the architectural design of any structure in the Capitol area on which they are mounted or to which they relate.

Statutory Authority: *MS s 15B.06*

History: *34 SR 900*

Published Electronically: *January 15, 2010*

2400.2905 CONSTRUCTION AND MAINTENANCE REQUIREMENTS.

A. All signs must conform to applicable provisions of the building code of the city of St. Paul as well as the structural design standards of the State Building Code in chapters 1300 to 1370.

B. Signs must not resemble any traffic control sign or signal so as to be confused with it. Signs must not interfere with the visibility of any traffic control sign or signal.

C. Signs that are unsafe or in disrepair must be repaired or removed. Unsafe signs must be repaired or removed within 24 hours after notification. Signs in disrepair must be repaired or removed within 15 days after notification.

"Disrepair" means a condition in which the sign has deteriorated to the point where at least one-fourth of the surface area of the name, identification, description, display, illustration, or other symbol is no longer clearly recognizable at a distance of 20 feet; where paint is peeling, chipping, or flaking from the structure surface; where the sign has developed significant rust, corrosion, rotting, or other deterioration in the physical appearance, or is so faded that it is not clearly recognizable at a distance of 20 feet; or where an illuminated electrical sign is no longer in proper working order.

Removal, in the case of painted wall signs, means a complete repainting of the background on which the sign was painted, or a sandblasting of the surface to reveal an exterior finish compatible with surrounding surfaces, so that no part of the sign is still visible.

D. Signs must not be painted directly on or affixed to any tree, rock, or utility pole.

E. Lots on which signs are located must be kept neat, orderly, and free of debris by the owner.

F. Any sign that advertises, identifies, or pertains to an activity no longer in existence must be removed by the owner of the property within 30 days from the time the activity ceases existence. This part does not apply to seasonal activities during the regular periods in which they are closed.

Statutory Authority: *MS s 15B.06*

History: *34 SR 900*

Published Electronically: *January 15, 2010*

2400.2910 SIGN PLACEMENT AND HEIGHT REQUIREMENTS.

A. Signs must not be located in, project into, or overhang a public right-of-way or dedicated public easement in any district, with the following exceptions:

- (1) city, county, state, or federal signs;
- (2) transit benches or shelters allowed under Minnesota Statutes, section 160.27;
- (3) temporary banners allowed under item F; or
- (4) projecting signs allowed under item D.

B. On buildings up to two stories in height, signs attached to a building must not project above the highest point used to measure the building height of any structure. On buildings of three stories or more in height, signs must not be placed on the exterior façade on or above the floor level of the third story.

Signs attached to buildings must be positioned so that they are an integral design feature of the building and to complement and enhance the building's architectural features. Signs must not obscure or destroy architectural details such as stone arches, glass transom panels, or decorative brickwork.

C. Signs mounted parallel to the wall or face of a building or structure may project a maximum of 18 inches horizontally beyond the wall or face of that building or structure.

D. Projecting signs, where allowed, may extend a maximum of four feet from the property line, and must be located at least two feet from the curb line and at least ten feet above ground level.

E. Freestanding pylon signs, where allowed, must not exceed 15 feet in height. Monument signs must not exceed 12 feet in height. Monument signs must include a masonry base with materials and design similar to the principal building.

F. Temporary signs, where allowed, must meet the criteria of one of the following categories:

(1) for all uses, one sign not exceeding 40 square feet in area may be used to identify an engineer, architect, or contractors engaged in the construction of a building during the construction period;

(2) for religious, civic, or other community organizations, the following temporary signs directly related to events on the premises are permitted for a maximum of three times per calendar year per organization, for a maximum of five consecutive days at any one event:

(a) portable or temporary signs, with a gross surface display area not exceeding 60 square feet and a height not exceeding six feet; and

(b) banners advertising an event on the premises, to include banners placed on or between buildings or within the street right-of-way, provided that they do not interfere with the visibility of any traffic control sign or signal. Banners shall not exceed 120 square feet in area and shall provide at least 20 feet of clearance from ground level. Banners must be approved by the city of St. Paul Department of Safety and Inspections.

Signs that span a public roadway cannot be attached to city light poles or traffic signal poles.

G. Sidewalk signs, where allowed, are limited to two feet in width and 3-1/2 feet in height, including the support members. No sign may have more than two faces. Changeable copy is permitted except for plastic letters. The sign may be placed only in front of the business advertised, without significantly limiting the normal pedestrian use of the sidewalk. One sign is permitted for each building or land frontage, and it must be removed from the sidewalk at the end of each business day. No sidewalk sign may be lighted.

Statutory Authority: *MS s 15B.06*

History: *34 SR 900*

Published Electronically: *January 15, 2010*

2400.2915 SIGN DESIGN STANDARDS.

A. No more than three colors may be used for the sign letters and no more than two colors for the sign background and border. A wall sign must complement the building color.

B. The sign message must be legible and relate to the nature of the business.

C. Neon lights are permitted when installed inside windows; neon lights may not flash.

D. Signs on multiple-use buildings must be coordinated in the use of colors, materials, and shapes.

E. Lettering styles must be legible and relate to the character of the property's use. Each sign may contain no more than four lettering styles.

F. Symbols and graphics, when used, must identify the business and complement the sign lettering.

G. Ground and pylon signs must have plantings at and around the base that serve to (1) screen the sign base or any lighting installed at ground level; and (2) tie the signage to the principal use by using plantings that are similar to those used on the rest of the site.

H. External illumination of signs is permitted by incandescent or fluorescent light, but must emit a continuous white light that prevents direct shining onto the ground or adjacent buildings.

I. Internally lit signs are permitted if illumination is confined to individual letters or symbols. Backlit "box" signs are prohibited. Internally illuminated canopy signs may be allowed with board approval.

Statutory Authority: *MS s 15B.06*

History: *34 SR 900*

Published Electronically: *January 15, 2010*

2400.2920 EXEMPT SIGNS.

The signs in items A to E do not require a permit. These exemptions do not relieve the owner of the sign from the responsibility of its erection, maintenance, and compliance with this chapter or any other law or ordinance regulating the sign:

A. signs six square feet or less in size;

B. lettering on motor vehicles when not utilized as a parked or stationary outdoor display sign;

C. political signs;

D. the changing of the display surface on a painted or printed sign, or the replacement of a poster, for on-site changes only; and

E. traffic control signs.

Statutory Authority: *MS s 15B.06*

History: *34 SR 900*

Published Electronically: *January 15, 2010*

2400.2925 PROHIBITED SIGNS.

The following types of signs are prohibited in the Capitol area:

- A. advertising signs or billboards;
- B. transit shelter and bench signs, with the exception of signs providing passenger information at transit stations;
- C. flashing, animated, or moving signs and signs illuminated with flashing lights;
- D. changeable copy signs and electronic message signs, with the exception of the following:
 - (1) signs providing passenger information at transit stations; and
 - (2) signs displaying prices of fuel and other goods at service stations, provided that:
 - (a) the total square footage of all electronic message signs on one lot does not exceed 35 percent of the allowable total signage for the property;
 - (b) each electronic message sign is equipped with a mechanism that adjusts to ambient light conditions and is set at a level no greater than 5,000 nits during the day and 500 nits between dusk and dawn;
 - (c) each electronic message sign has a means to immediately turn off the display or lighting in the event that the operator is notified by the appropriate zoning authority that the sign is not in compliance with the local zoning code; and
 - (d) each electronic message sign is at least 75 feet from the nearest residential property;
- E. roof signs;
- F. vehicle signs; and
- G. portable signs mounted on a wheeled chassis.

Statutory Authority: *MS s 15B.06*

History: *34 SR 900*

Published Electronically: *January 15, 2010*

2400.2930 SIGNS ALLOWED IN ALL DISTRICTS.

The following types of signs are allowed in all districts in the Capitol area:

- A. signs of the city of St. Paul, Ramsey County, and state and federal governments and their subdivisions and agencies that give orientation, direction, or traffic control information; and
- B. parking lot signage as follows is permitted in addition to other signs permitted in each zoning district:
 - (1) for parking lot areas, one identification sign a maximum of 15 square feet in area is permitted per parking lot entrance. The identification sign up to 25 square feet in area is allowed if the sign incorporates an accepted uniform parking symbol "P." The remaining portion of the sign incorporating the parking symbol may be used for other pertinent information; and

(2) one directional sign not to exceed four square feet in area is permitted per entrance or exit. Directional signs may be up to ten square feet in area if they also incorporate the parking symbol "P."

Statutory Authority: *MS s 15B.06*

History: *34 SR 900*

Published Electronically: *January 15, 2010*

2400.2935 SIGNS PERMITTED BY DISTRICT.

The following table indicates signs permitted by district. A number represents the total surface square footage permitted. "P" means permitted. "N" means not permitted.

"Building-mounted sign" includes wall, canopy, awning, marquee, or projecting signs. "Freestanding sign" includes pylon signs and monument signs.

Sign Functional Type:	Use Districts				Max. number of signs per lot
	G-1/G-2	RM	MX	MXD	
Business sign, single-use building	N	N	2 sq. ft. per lineal foot of lot frontage, up to 250 sq. ft.	4 sq. ft. per lineal foot of lot frontage	Square footage is maximum of all business signs per lot. May include 1 building-mounted sign per street frontage; 1 freestanding sign per street frontage
Business signs, multitenant building	N	N	2 sq. ft. per lineal foot of lot frontage, up to 350 sq. ft.	4 sq. ft. per lineal foot of lot frontage	Square footage is maximum of all business signs per lot. May include 1 building-mounted sign per business; 1 freestanding sign per street frontage
Directional sign	25	N	15	15	1 per street frontage
Identification and name plate signs	50	7	50	50	1 per street frontage
Political sign	N	P	P	P	
Real estate sign	N	6	25	25	1

Real estate development sign	N	50	50	50	1
Temporary	P	P	P	P	1 (see part 2400.2910, item F)
Sign Structural Type:					
Canopy, awning, or marquee sign	N	N	P	P	see Business sign standards
Freestanding sign (<10 ft.)	P	N	P	P	1 per street frontage (Business or Identification sign)
Illuminated sign	P	N	P	P	
Monument sign	P	N	P	P	1 per street frontage (Business or Identification sign)
Projecting sign	N	N	20	25	see Business sign standards
Pylon sign (10 feet or greater)	N	N	P	N	see Business sign standards
Sidewalk sign	N	N	6	6	1
Wall sign	P	P	P	P	See Business sign or nameplate standards
Window sign	N	N	20 sq. ft., max. of 50% of total window area	20 sq. ft., max. of 50% of total window area	2 poster-type per window. Neon signs inside windows allowed in addition to poster signs; total area of all signs shall not exceed 50% of window area

Statutory Authority: *MS s 15B.06*

History: *34 SR 900*

Published Electronically: *January 15, 2010*

2400.2940 NONCONFORMING SIGNS.

When a lawful sign exists on January 5, 2010, but does not conform with this chapter, the requirements in items A to F apply.

- A. No sign may be enlarged or altered in a way that increases its nonconformity.
- B. If a sign or sign structure is destroyed by any means to any extent of more than 51 percent of its replacement cost, it must not be repaired or reconstructed except in conformity with this chapter.
- C. If a sign or sign structure is moved for any reason for any distance, it must conform to the rules for the zoning district in which it is located after it is moved.
- D. An existing sign devoted to a use not permitted by this chapter in the zoning district in which it is located must not be enlarged, extended, or moved except to change the sign to one that is permitted in the zoning district in which it is located.
- E. When a structure loses its nonconforming status under parts 2400.3000 to 2400.3020, all signs located on or pertaining to the structure must be removed and all signs painted directly on the structure must be repainted in a neutral color or a color that will harmonize with the structure.
- F. Signs may be repainted, reposted, or replaced when there is a change of tenancy, ownership, or management of any nonconforming use.

Statutory Authority: *MS s 15B.06*

History: *34 SR 900*

Published Electronically: *January 15, 2010*

2400.3000 INTENT.

Regulations governing nonconforming uses and structures are established to control the continued existence of legal nonconforming uses and structures by bringing about their gradual elimination; by regulating their enlargement, intensification, expansion, or reconstruction; by prohibiting their reestablishment after abandonment or destruction; and by regulating the use of and construction on nonconforming lots.

Statutory Authority: *MS s 15B.06*

History: *34 SR 900*

Published Electronically: *January 15, 2010*

2400.3005 GENERAL PROHIBITION; AUTHORITY TO CONTINUE.

A nonconforming use or structure may continue, subject to items A to E.

- A. Nonconforming uses and structures that were not lawfully in existence on January 5, 2010, are prohibited.
- B. If nonconforming use of land ceases for any reason for a period of three months or more, any subsequent use of the land must conform to this chapter.

C. If a nonconforming use of structure and land in combination is discontinued or ceases to exist for 12 consecutive months or for 18 months during a three-year period, the structure and land must thereafter conform to this chapter.

D. If a nonconforming structure is destroyed by any means to an extent of more than 60 percent of its replacement cost, exclusive of the foundation at the time of destruction, it may not be reconstructed except in conformity with this chapter.

E. If a structure is moved for any reason or for any distance, it must conform to the rules for the district in which it is located after it is moved.

Statutory Authority: *MS s 15B.06*

History: *34 SR 900*

Published Electronically: *January 15, 2010*

2400.3010 REPAIRS AND MAINTENANCE.

A. On any building devoted in whole or in part to a nonconforming use, work may be done in any period of 12 consecutive months on ordinary repairs, or on repair or replacement of nonbearing walls, fixtures, wiring, or plumbing to an extent not exceeding 50 percent of the current market value of the building, provided that the cubic content of the building as it existed on January 5, 2010, is not increased.

B. Nothing in this chapter shall be deemed to prevent the strengthening or restoring to a safe condition of any building or part of a building declared to be unsafe by an official charged with protecting the public safety upon order of the official.

Statutory Authority: *MS s 15B.06*

History: *34 SR 900*

Published Electronically: *January 15, 2010*

2400.3015 CHANGE OF TENANCY OR OWNERSHIP.

There may be a change of tenancy, ownership, or management of any existing nonconforming uses of land, structures, and premises, provided there is no change in the nature or character of nonconforming uses.

Statutory Authority: *MS s 15B.06*

History: *34 SR 900*

Published Electronically: *January 15, 2010*

2400.3020 NONCONFORMING LOTS.

Subpart 1. **General restriction, exception.** No building, structure, or use may be erected, constructed, or established on a nonconforming lot unless a variance is granted by the board under part 2400.3160, except as otherwise provided in this part.

In a district in which one-family dwellings are permitted, notwithstanding any limitations imposed by this chapter, a one-family dwelling and customary accessory buildings may be erected on a lot of record existing on January 5, 2010, provided that the yard dimensions and all other requirements for the district in which the lot is located, not involving lot area or lot width, are met. Yard requirement variances may be obtained through approval of the board.

Subp. 2. Required merger of common ownership lots. Notwithstanding subpart 1, if in any group of three or more contiguous lots or parcels of land owned or controlled by the same person, any individual lot or parcel is nonconforming as to lot width or lot area, the individual lot or parcel may not be sold or developed as a separate parcel of land, but must be combined with adjacent lots or parcels under the same ownership or control so that the combination of lots or parcels will equal one or more parcels of land, each meeting the full lot width and lot area requirements of this chapter.

Statutory Authority: *MS s 15B.06*

History: *34 SR 900*

Published Electronically: *January 15, 2010*

2400.3100 SCOPE.

Parts 2400.3100 to 2400.3130 establish application requirements, review processes, and standards for land use approvals and development permits in the Capitol area, as authorized by Minnesota Statutes, section 15B.06.

Statutory Authority: *MS s 15B.06*

History: *34 SR 900*

Published Electronically: *January 15, 2010*

2400.3105 DUTIES OF BOARD.

The board must accept applications for and issue any certificate or permit required by this chapter; keep and maintain all plans, files, and records pertaining to them; and perform all other functions necessary for the orderly administration of this chapter. The board may delegate any or all of these duties to the zoning administrator with the exception of approval for variances or conditional use permits.

Statutory Authority: *MS s 15B.06*

History: *34 SR 900*

Published Electronically: *January 15, 2010*

2400.3110 GENERAL REQUIREMENTS.

No land, building, sign, or structure in any district may be changed to a different use, and no building, structure, sign, or part of a building or structure may be erected, constructed, reconstructed, altered, enlarged, or moved until the board has issued a sign permit or a zoning permit and a certificate of design compliance certifying that the plans and intended use of land, buildings, and structures conform to the requirements of this chapter.

Statutory Authority: *MS s 15B.06*

History: *34 SR 900*

Published Electronically: *January 15, 2010*

2400.3115 ST. PAUL PERMIT REQUIREMENTS.

In addition to the requirements of part 2400.3110, no building, structure, or part of a building or structure may be erected, constructed, reconstructed, altered, enlarged, or moved until it has been issued a building permit by the city of St. Paul, or the appropriate state agency, certifying that the plans of the building or structure conform to the State Building Code.

Statutory Authority: *MS s 15B.06*

History: *34 SR 900*

Published Electronically: *January 15, 2010*

2400.3120 SUBDIVISIONS OF PROPERTY.

All subdivisions of property, including lot splits, adjustments of boundaries, and plats, are subject to the applicable subdivision regulations of the city of St. Paul.

Statutory Authority: *MS s 15B.06*

History: *34 SR 900*

Published Electronically: *January 15, 2010*

2400.3125 DETERMINATION OF SIMILAR USE.

When a specific use is not listed in a district, the zoning administrator must make the determination of whether a use is similar to other uses permitted in each district. The decision must be based on the following findings:

- A. that the use is similar in character to one or more of the principal uses permitted;
- B. that the traffic generated on the use is similar to one or more of the principal uses permitted; and
- C. that the use is not first permitted in a less restrictive zoning district.

Statutory Authority: *MS s 15B.06*

History: *34 SR 900*

Published Electronically: *January 15, 2010*

2400.3130 APPLICATION AND REVIEW PROCEDURES.

Subpart 1. **Submittal of application.** Applications for the permits and certificates listed in parts 2400.3135 to 2400.3160 must be submitted to the zoning administrator. The zoning administrator must determine whether all the information required by parts 2400.3135 to 2400.3160

has been provided. The zoning administrator must notify the applicant in writing within ten days of receipt of the application if the application is incomplete and state what information is missing.

Subp. 2. **Timing.** Once the application is complete, the application must be approved or denied within 60 days of the zoning administrator's receipt of the complete application, except as described in items A to C.

A. If the zoning administrator extends the consideration period, the zoning administrator must provide written notice to the applicant that the time is being extended, the anticipated length of the extension, and the reasons for the extension. The extension may not exceed 60 days unless approved by the applicant.

B. If the application is for a certificate of design compliance under part 2400.3140, the time limit is automatically extended by 60 days to provide additional time to study the effect of the proposal on the beauty, dignity, and architectural integrity of the Capitol area.

C. If the application is for a variance under part 2400.3160, the time limit is automatically extended by 60 days to provide additional time to solicit the necessary public input on the proposal.

Subp. 3. **Approval or denial.** Applications must be approved if they meet the requirements of this chapter. If the application is denied, reasons for the denial must be stated in writing as required by Minnesota Statutes, section 15.99.

Subp. 4. **Expiration of permit.** A zoning permit or certificate of design compliance expires one year from the date of issuance, unless a building permitted for erection or alteration is started and is proceeding with the terms of its permit or certificate.

Statutory Authority: *MS s 15B.06*

History: *34 SR 900*

Published Electronically: *January 15, 2010*

2400.3135 ZONING PERMIT APPLICATION.

All applications for zoning permits must be submitted in writing to the zoning administrator and contain:

- A. the legal description of the property in question;
- B. the fee owner of the property, and, in all cases where the applicant is not the fee owner of the property, the nature of the applicant's interest in the property;
- C. a concise description of the proposed use, including accessory and conditional uses, if any;
- D. three copies of a site plan meeting the standards of part 2400.3150; and
- E. other information as may be reasonably necessary to permit the board to determine whether the proposed use, including accessory and conditional uses, satisfies the requirements of this chapter.

Any applicant may present additional information, in a form the board permits, that is relevant to the nature of the proposed use and its relation to and effect upon adjacent uses and the beauty, dignity, and architectural integrity of the Capitol area.

General Application Process

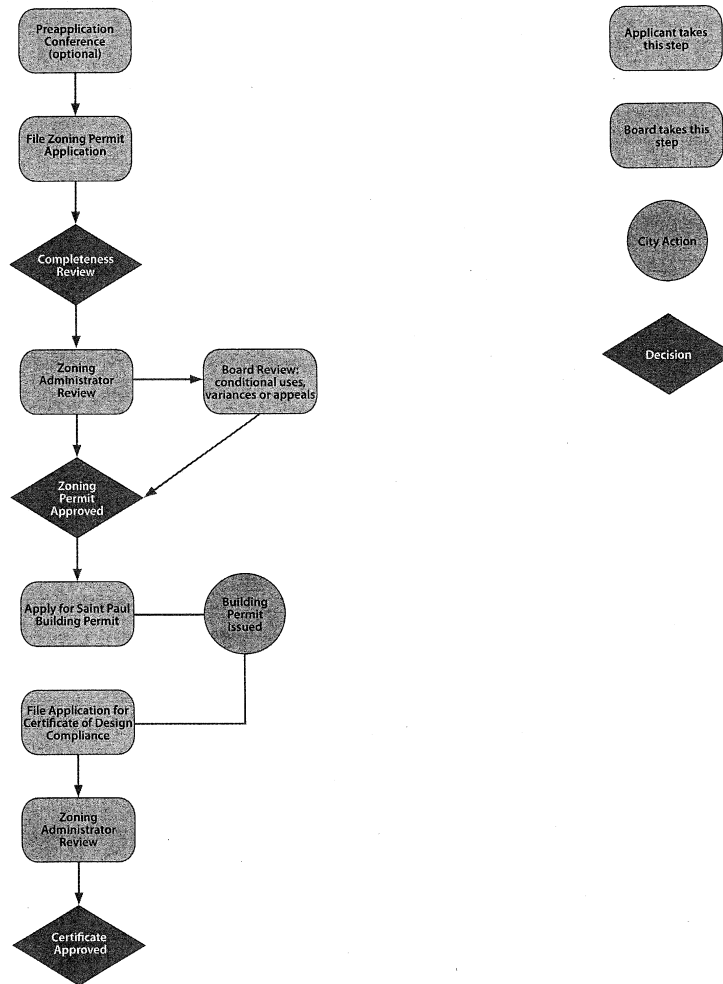

Statutory Authority: *MS s 15B.06*

History: *34 SR 900*

Published Electronically: *January 15, 2010*

2400.3140 CERTIFICATE OF DESIGN COMPLIANCE APPLICATION.

A certificate of design compliance is required following the issuance of a zoning permit issued by the board and a building permit issued by the city of St. Paul in order to certify that the plans of the building or structure conform to the design rules in parts 2400.2400 to 2400.2410.

All applications for a certificate of design compliance shall be submitted in writing and shall include three copies of the following, in addition to the requirements for a zoning permit:

A. plans, sections, and elevations of the proposed structure drawn to scale, showing the overall dimensions of the exterior faces of the structure; the proposed type and location of any sign or other appurtenances such as overhangs, housing for utilities, and television or radio antennas, and showing in outline form other adjacent buildings and structures; and landscape features within a reasonable distance that will be seen when looking at any elevations of the structure;

B. the final construction drawings as approved by the city, including changes to the design, if any, since the zoning permit was issued;

C. for all applications except those for one- and two-family dwellings, landscape plans and site plans prepared by a licensed design professional, including any landscaping required for off-street parking; and

D. other information as may be reasonably necessary to permit the board to determine whether the proposed construction or reconstruction satisfies the requirements of this chapter.

Statutory Authority: *MS s 15B.06*

History: *34 SR 900*

Published Electronically: *January 15, 2010*

2400.3145 SIGN PERMIT APPLICATION.

Applications for sign permits must be submitted in writing to the zoning administrator. Each application must contain:

A. the name and address of the applicant and the location at which any signs are to be erected, including the lot, block, and addition, and the street on which they are to front; and

B. a complete set of plans showing the necessary elevations, distances, size, and other details to fully and clearly represent the construction and placement of the display structure.

The zoning administrator must issue a sign permit provided that plans conform to parts 2400.2900 to 2400.2940.

Statutory Authority: *MS s 15B.06*

History: *34 SR 900*

Published Electronically: *January 15, 2010*

2400.3150 SITE PLAN CONTENTS AND REVIEW.

Subpart 1. **Contents of site plan.** A site plan, when required by parts 2400.3150 to 2400.3160, must be drawn to scale and specifications, showing:

- A. the actual shape, location, and dimensions of the zoning lot;
- B. the shape, size, and location of buildings or other structures to be erected, altered, or moved and of any building or other structures already on the zoning lot;
- C. the existing and intended use of the zoning lot and of all structures upon it, including, where applicable, the number of dwelling units the building is intended to accommodate;
- D. the layout of parking and pedestrian and vehicular circulation on the zoning lot;
- E. landscape, screening, and fencing plans; and
- F. other information concerning the zoning lot or adjoining lots determined by the zoning administrator as essential for determining whether the provisions of this chapter are being met.

Subp. 2. **Consideration of site plan.** In reviewing the site plan, the board shall consider:

- A. the location and design of driveways providing vehicular ingress to and egress from the site, in relation to streets giving access to the site and in relation to pedestrian traffic, subject to final approval by the city of St. Paul;
- B. traffic circulation features within the site and location of automobile parking areas. The board may impose requirements that will ensure:
 - (1) safety and convenience of vehicular and pedestrian traffic within the site and in relation to access streets; and
 - (2) compatibility between the development on the site and the existing and prospective development of abutting land and adjacent neighborhoods;
- C. the arrangement of buildings, uses, and facilities of the proposed development to ensure abutting property or its occupants will not be unreasonably affected; and
- D. the extent, location, and level of increased activity anticipated for the use to ensure compatibility with the Capitol area comprehensive plan and any applicable subarea plans that were approved by the board.

Statutory Authority: *MS s 15B.06*

History: *34 SR 900*

Published Electronically: *January 15, 2010*

2400.3155 CONDITIONAL USES.

Subpart 1. **Conditional use application.** A conditional use application requires submittal to the board of a site plan and description of the proposed use. A conditional use is permitted upon a

finding by the board that the use is specifically enumerated as a conditional use for the district and that, if established, the use:

- A. will not materially adversely affect the general character of existing principal uses;
- B. will not adversely affect the beauty, dignity, and architectural integrity of the Capitol area; and
- C. will be established under the conditions and requirements for the uses enumerated in this chapter and additional conditions and requirements as the board may impose to ensure compliance with items A and B.

Subp. 2. **Change to conditional use.** A change to a conditional use requires a new permit when one of the following conditions occurs:

- A. a conditional use changes from one conditional use to another conditional use;
- B. the floor area of a conditional use expands by 50 percent or more. Floor area does not include floor area that is accessory to a principal use and that does not result in the expansion of a principal use;
- C. the building containing a conditional use is torn down and a new building is constructed, even if the new building contains the same or less floor area;
- D. the principal use of a conditional use expands onto an abutting lot; or
- E. the number of residents in a community residential facility increases, or the number of rooming units in a rooming or boarding house increases.

Subp. 3. **Expiration of conditional use permit.** Unless expressly provided by the board, a conditional use permit automatically expires and a new permit must be applied for when any of the following circumstances exist:

- A. a use requiring a conditional use permit is discontinued or ceases to exist for a continuous period of 365 days;
- B. a conditional use changes to a permitted use not requiring a conditional use permit;
- C. the lot area of a conditional use is subsequently reduced in size; or
- D. a conditional use becomes nonconforming and subsequently is discontinued or ceases to exist for a continuous period of one year.

Statutory Authority: *MS s 15B.06*

History: *34 SR 900*

Published Electronically: *January 15, 2010*

2400.3160 VARIANCES.

Subpart 1. **Variance application.** An application for a variance from the requirements of this chapter must be submitted to the zoning administrator and contain:

A. a statement setting forth the precise nature and extent of the proposed variance and the reasons the variance is being requested;

B. supporting documentation necessary to provide a complete description of the proposal including site plan, architectural plans and drawings, topographical information, and project cost data; and

C. a detailed statement addressing each of the applicable variance criteria contained in this chapter and the reasons the variance request conforms to those criteria.

Subp. 2. **Disposition of variance requests.** The board shall grant or deny a variance request pursuant to the procedures in items A to E and the standards in subpart 3.

A. Upon receipt of a variance request or the determination by the zoning administrator that a variance is needed, the zoning administrator must send written notice to all persons who have registered their names with the board for the purpose of being notified of rulemaking proceedings or variance requests and to all parties who may be affected by the decision. The notice must be sent to all owners and possessors of record of property within 350 feet of the property.

The notice must contain a brief description of the variance request, a statement that any person wishing to comment on the request may do so in writing, and a statement that the board will not act on the variance request until interested persons have been afforded at least 30 calendar days after the issuance of the notice to submit their comments.

B. If, after receiving the variance request, the board determines that additional information is needed, it may direct the person seeking the variance to submit additional data regarding the variance request to the board or the zoning administrator or to appear before the board or the zoning administrator to provide additional information.

C. To facilitate full consideration of a variance request, the board may, in its discretion, request that the person seeking the variance and other persons who have submitted written comments regarding the variance appear before the board to make arguments to the board. The board must provide persons requested to appear notice of the request at least seven days before the board meeting at which the variance request is to be considered. This procedure does not constitute a contested case as defined in Minnesota Statutes, section 14.02, subdivision 3.

D. If a person requesting a variance fails to follow the variance procedures specified in this part, the variance shall be denied.

E. Within 30 days after its action on the request, the board must set forth in writing and submit to the person requesting the variance and other persons who have submitted written comments the reasons why it has granted or denied the variance request.

Subp. 3. **Standards for review of variance requests.** The board may grant a variance to the application of any of its rules, except for its design standards and sign rules, only if it determines that all of the following criteria have been met:

A. the property in question cannot be put to a reasonable use under the strict application of the rules;

B. the plight of the landowner is due to circumstances unique to the property, and the circumstances were not created by the landowner;

C. the proposed variance is in keeping with the spirit and intent of this chapter and is consistent with the health, safety, comfort, morals, and welfare of the inhabitants of the Capitol area and the city of St. Paul;

D. the proposed variance does not impair an adequate supply of light and air to adjacent property, nor does it alter the essential character of the surrounding area or unreasonably diminish established property values within the surrounding area;

E. the variance request, if granted, does not permit any use that is not permitted under this chapter for the property in the district where the affected land is located, nor does it alter or change the zoning district classification of the property; and

F. the request for variance is not based solely on the desire to increase the value or income potential of the land parcel.

Subp. 4. **Variations to design standards.** The board may grant a variance to the application of the design standards in this chapter only if it determines that:

A. strict application of the design rules would prevent implementation of a design that, in terms of meeting the intent of this chapter, is equal to or superior to the design alternatives authorized by this chapter; and

B. the criteria in subpart 3, items B to F, have been met.

Subp. 5. **Variations to sign rules.** The board may grant a variance to application of its sign rules only if it determines that:

A. unusual conditions exist with respect to a specific building or lot that require the installation of a unique sign;

B. the granting of the variance does not result in the installation of a sign in a zoning district in which such a sign is not permitted by this chapter; and

C. the criteria in subpart 3, items B to F, have been met.

Statutory Authority: *MS s 15B.06*

History: *34 SR 900*

Published Electronically: *January 15, 2010*

2400.3165 REZONINGS AND ZONING AMENDMENTS.

Any person or entity wanting to amend the zoning rules or petition for rezoning must follow the procedures for petition for adoption of a rule in the Administrative Procedure Act, Minnesota Statutes, chapter 14.

Statutory Authority: *MS s 15B.06*

History: *34 SR 900*

Published Electronically: *January 15, 2010*

2400.3170 APPEALS.

Any decision of the zoning administrator may be appealed to the board within ten days of the time the applicant or property owner is notified of the zoning administrator's decision. The board must act upon the appeal following the same procedures specified for variance requests in part 2400.3160.

Decisions of the board may be appealed using the procedures for determination of validity of a rule in the Administrative Procedure Act, Minnesota Statutes, chapter 14.

Statutory Authority: *MS s 15B.06*

History: *34 SR 900*

Published Electronically: *January 15, 2010*

2400.3175 ENFORCEMENT AND PENALTIES.

The zoning administrator must enforce this chapter and has the power to certify zoning compliance and to make inspections of premises necessary to carry out duties as outlined in this chapter.

A person who violates any zoning rule is guilty of a misdemeanor under Minnesota Statutes, section 15B.06. The board may move to abate, by injunction, a violation of these zoning rules.

Statutory Authority: *MS s 15B.06*

History: *34 SR 900*

Published Electronically: *January 15, 2010*

2400.3180 FEES.

Fees for inspection and the issuance of permits or certificates required or issued under this chapter must be collected by the zoning administrator in advance of issuance. The amount of the fees must be established by resolution of the board and shall cover the cost of notification, inspection, and supervision resulting from enforcement of this chapter. The fee schedule is available on request at the board offices.

When any fees are not paid within six months of authorization of any permit or certificate, the authorization is null and void.

Statutory Authority: *MS s 15B.06*

History: *34 SR 900*

Published Electronically: *January 15, 2010*