

**CHAPTER 5230**  
**DEPARTMENT OF LABOR AND INDUSTRY**  
**PIPEFITTERS; POWER PIPING SYSTEMS**

5230.0010	ORGANIZATION AND DUTIES OF ADVISORY COUNCIL FOR PIPEFITTING EXAMINATIONS.	5230.0690	BOLTING.
5230.0020	DUTIES OF THE SECRETARY.	<b>STEAM PRESSURES ABOVE 25 PSI BUT NOT ABOVE 125 PSI AND TEMPERATURES NOT IN EXCESS OF 450 DEGREES FAHRENHEIT</b>	
5230.0030	QUALIFICATIONS AND DUTIES OF INSPECTORS.	5230.0750	VALVES.
5230.0040	DEFINITIONS.	5230.0760	FITTINGS.
5230.0050	LICENSING AND REGISTRATION REQUIREMENT.	5230.0770	PIPE JOINTS.
5230.0060	APPLICATIONS FOR REGISTRATION.	5230.0780	PIPE.
5230.0070	PIPEFITTER QUALIFICATIONS.	5230.0790	BOLTING.
5230.0080	JOURNEYMAN PIPEFITTER QUALIFICATIONS.	<b>STEAM PRESSURES 25 PSI AND BELOW AND TEMPERATURES NOT IN EXCESS OF 450 DEGREES FAHRENHEIT</b>	
5230.0090	EXAMINATION OF APPLICANTS FOR LICENSES.	5230.0850	VALVES.
5230.0100	FEES.	5230.0860	FITTINGS.
5230.0115	PIPEFITTER TRAINEES.	5230.0870	PIPE JOINTS.
5230.0120	RIGHTS OF LICENSED CONTRACTING PIPEFITTER.	5230.0880	PIPE.
5230.0130	DUTIES OF LICENSED CONTRACTING PIPEFITTERS.	5230.0890	BOLTING.
5230.0140	DISPLAY OF LICENSES.	5230.0950	BOILER FEED SYSTEMS AND OTHER WATER PIPING NOT OTHERWISE COVERED.
5230.0150	RIGHT TO DO BUSINESS.	5230.0960	BOILER FEED PIPING.
5230.0160	SEVERANCE OF LICENSEE.	5230.0970	BLOWOFF PIPING AND TANKS.
5230.0170	CHANGES AND TRANSFERS OF LICENSE.	5230.0980	WATER COLUMN.
5230.0180	SURRENDER OF LICENSE UPON REVOCATION.	5230.0990	SAFETY VALVES.
5230.0190	DUPLICATE LICENSES.	5230.1000	STEAM PIPING.
5230.0200	AUTOMATIC REINSTATEMENT.	5230.1010	SERVICE WATER AND CONDENSING WATER SYSTEMS.
5230.0210	RENEWAL AFTER REVOCATION.	5230.1020	INSTRUMENT AND CONTROL PIPING.
<b>CODE FOR POWER PIPING SYSTEMS</b>			
5230.0250	PURPOSE.	5230.1030	FABRICATION OF PIPE HANGERS, SUPPORTS, ANCHORS, SWAY BRACINGS, AND VIBRATION DAMPENERS.
5230.0260	SCOPE.	5230.1040	SPACING BETWEEN PIPE SUPPORTS.
5230.0270	REFERENCES TO STANDARDS AND SPECIFICATIONS.	5230.1050	FABRICATION OF PIPE JOINTS OTHER THAN WELDED.
5230.0280	REQUIRED COMPLIANCE.	5230.1060	EXPANSION AND FLEXIBILITY.
5230.0290	MINIMUM CONSTRUCTION STANDARD.	5230.1070	WELDING OF PIPE JOINTS.
5230.0300	DIMENSION GUIDE.	5230.1080	STANDARD QUALIFICATION FOR WELDING PROCEDURES, WELDERS, AND WELDING OPERATORS.
5230.0310	PRESSURES AND TEMPERATURES.	5230.1090	PROCEDURE QUALIFICATION.
5230.0320	MATERIALS.	5230.1100	PERFORMANCE QUALIFICATION.
5230.0330	TABLE 1 DEFINED.	5230.1110	RECOMMENDED FORMS OF PROCEDURE SPECIFICATION.
5230.0340	FLANGES.	5230.1120	MATERIALS; THEIR SPECIFICATIONS AND IDENTIFICATION.
5230.0350	VALVES.	5230.1130	FITTINGS FOR INSTRUMENT AND CONTROL PIPING.
5230.0360	PRESSURE-REDUCING AND RELIEF VALVES.	5230.1200	FIGURE 3: RECOMMENDED END PREPARATIONS.
5230.0370	FITTINGS.	5230.1210	FIGURE 4: BUTT WELDING OF PIPES OR FITTINGS OF UNEQUAL WALL THICKNESSES.
5230.0380	SPECIAL FITTINGS.	5230.1220	FIGURE 5: TYPICAL JOINTS WITH BACKING RING.
5230.0390	BOLTING.	5230.1230	FIGURE 6: DETAILS OF WELDING FLANGES.
5230.0400	PIPE THREADS.	5230.1240	FIGURE 7: MINIMUM DIMENSIONS REQUIRED FOR SOCKET WELD FITTINGS.
5230.0410	PIPE JOINTS.	5230.1250	FIGURE 8: POSITIONS OF GROOVE WELDS.
5230.0420	SUBSTITUTE REQUIREMENTS.	5230.1260	FIGURE 9: QUALIFYING POSITIONS.
5230.0430	GASKETS.	5230.1270	ORDER OF REMOVAL OF TEST SPECIMENS.
5230.0440	THERMAL EXPANSION.	<b>AMMONIA REFRIGERATION SYSTEMS</b>	
5230.0450	HANGERS, SUPPORTS, AND ANCHORS.	5230.5000	MINIMUM STANDARDS.
5230.0460	PIPE SLEEVES.	5230.5010	INCORPORATIONS BY REFERENCE.
5230.0470	DRAINS, DRIPS, AND STEAM TRAPS.	5230.5015	AMMONIA TASK FORCE.
5230.0480	INSPECTION AND TESTS.	5230.5020	DEFINITIONS.
5230.0490	CLEANING.	5230.5025	AMMONIA GOVERNED AND DEFINED.
5230.0500	HYDROSTATIC TESTS.	5230.5250	LOCATIONS GOVERNED AND DEFINED.
5230.0510	THICKNESS OF PIPE.	5230.5300	REFRIGERATING SYSTEM CLASSIFICATION BY TYPE.
5230.0520	VARIATIONS IN PRESSURE AND TEMPERATURE.	5230.5350	RESTRICTIONS ON PLACEMENT OF AMMONIA PIPING. LIMITATIONS ON SYSTEM SIZING, AND PRESSURE RELIEF VENTING REQUIREMENTS.
<b>SPECIFIC REQUIREMENTS; STEAM PRESSURES ABOVE 350 PSI AND NOT ABOVE 2,500 PSI AND TEMPERATURES NOT IN EXCESS OF 1,100 DEGREES FAHRENHEIT</b>			
5230.0550	VALVES.	5230.5400	REQUIREMENTS FOR INDUSTRIAL OCCUPANCIES.
5230.0560	FITTINGS.	5230.5605	AIR COOLED CONDENSERS.
5230.0570	PIPE JOINTS.	5230.5610	AIR COOLED DESUPERHEATERS.
5230.0580	PIPE.	5230.5615	COMPRESSORS.
5230.0590	PIPES FOR SPECIAL USES.	5230.5620	EVAPORATIVE CONDENSERS.
5230.0600	OTHER PIPE PERMITTED.		
5230.0610	BOLTING.		
<b>STEAM PRESSURES ABOVE 125 PSI AND NOT ABOVE 250 PSI AND TEMPERATURES NOT IN EXCESS OF 450 DEGREES FAHRENHEIT</b>			
5230.0650	VALVES.		
5230.0660	FITTINGS.		
5230.0670	PIPE JOINTS.		
5230.0680	PIPE.		

# MINNESOTA RULES 2007

991

## PIPEFITTERS; POWER PIPING SYSTEMS 5230.0010

5230.5625	SHELL AND TUBE CONDENSERS.	5230.5820	ELECTRICAL STANDARDS FOR AMMONIA INSTALLATIONS.
5230.5630	PRESSURE VESSELS.	5230.5825	INSULATION.
5230.5635	EVAPORATORS.	5230.5915	PIPING JOINTS.
5230.5640	REFRIGERANT PUMP.	5230.5925	WELDING.
5230.5645	REFRIGERATION CONTROL VALVES.	5230.5930	STOP VALVES.
5230.5650	CONTROLS; ELECTRIC; PNEUMATIC.	5230.5935	MISCELLANEOUS MATERIALS.
5230.5655	PRESSURE RELIEF DEVICES.	5230.5940	PIPING HANGERS AND SUPPORTS.
5230.5660	SETTING OF PRESSURE RELIEF DEVICES.	5230.5945	PRESSURE RELIEF PROTECTION.
5230.5665	PRESSURE VESSEL PROTECTION.	5230.5950	INSTALLATION REQUIREMENTS.
5230.5675	TESTING.	5230.5960	FOUNDATIONS AND EQUIPMENT.
5230.5680	CONSTRUCTION MATERIAL SELECTION; PIPE, VALVES, FITTINGS, ACCESSORIES.	5230.6100	SYSTEM TESTING.
5230.5690	ULTIMATE STRENGTH REQUIREMENT.	5230.6110	SIGNS.
5230.5700	BUILDING STRUCTURE AND MACHINE ROOM DESIGN.	5230.6115	REFRIGERANTS.
5230.5705	OPEN FLAMES.	5230.6120	MASKS OR HELMETS.
5230.5710	VENTILATION FOR MACHINERY ROOMS	5230.6125	MAINTENANCE AND OPERATION.
		5230.6130	DECLARATION OF TEST.
		5230.6200	AMMONIA HANDLING AND STORAGE.

### 5230.0010 ORGANIZATION AND DUTIES OF ADVISORY COUNCIL FOR PIPE-FITTING EXAMINATIONS.

**Subpart 1. Election of chair and secretary.** The council shall organize by electing from its members a chair and a secretary, which elections must be confirmed by the commissioner, Department of Labor and Industry before becoming effective.

**Subp. 2. Biannual examinations.** The council shall meet not less than two times a year for examinations and shall meet at such other times as it deems necessary or when called by the secretary.

**Subp. 3. Examination and certification.** The council shall examine all applicants for contracting or journeyman pipefitters' licenses, and after being satisfied of an applicant's qualifications and passage of the examination, shall certify the applicant to the department for issuance of a license.

**Subp. 4. Violations by licensee.** Upon information coming to the council of any licensee having obtained a license through error, misrepresentation, or fraud, or of the licensee's incompetency, or of a willful violation of any of the rules applicable to the work of pipefitting or to the adopted Code of Minimum Standards, the council shall make an investigation as to the probable truth of such information. If the facts elicited by such investigation appear to warrant a suspension or revocation of the licensee's license, the council shall file with the commissioner written charges against the licensee and recommendation for the suspension for a stated length of time or revocation of the license. Thereupon, the commissioner shall proceed in accordance with the provisions of Minnesota's Administrative Procedure Act. If the license is suspended, it shall be reinstated at the end of the period of suspension, and if it is revoked an application for a new license cannot be made within one year from the date of revocation.

**Subp. 5. Reinstatement of suspended license.** If any person whose license has been suspended or revoked has adjusted the cause for the suspension or revocation in a manner satisfactory to the council, or if the period of suspension has elapsed, the council shall so certify to the commissioner who may reinstate the suspended license or reissue the revoked license to such person, as the case may be, for the remainder of the license year.

**Subp. 6. Recommendation for dismissal.** The council shall notify the department of any misbehavior, neglect of duty, or incompetency, with a recommendation for dismissal if it deems the charge to be of sufficient gravity.

**Subp. 7. Change in rules.** The council shall recommend to the department any changes it deems advisable to these rules or the Code of Minimum Standards.

**Subp. 8. Records.** The council shall keep a record of all meetings, hearings, and examinations.

**Subp. 9. Interpretation of code.** The council shall determine questions of interpretation of provisions of the Code of Minimum Standards, which determinations shall be subject to review by the department, and shall submit questions of interpretation of the law or of these rules directly to the department.

**Subp. 10. Performance of duties.** The council shall faithfully perform duties outlined by the Code of Minimum Standards and these rules.

Subp. 11. **Member approval.** A member of the council may be removed during the member's term of office in accordance with Minnesota Statutes, section 15.059, subdivision 4.

**Statutory Authority:** *MS s 175.171; 326.48*

**History:** *14 SR 1877; 17 SR 1279*

NOTE: This part is repealed effective December 1, 2007, by Laws 2007, chapter 140, article 13, section 3.

### 5230.0020 DUTIES OF THE SECRETARY.

The secretary of the council shall be an employee of the department and have general charge of the office of the Pipefitting Division and its books and records, including those of the council. Specifically, the duties shall include the following:

A. to maintain a record of all proceedings of the council, together with the necessary registers pertaining to applications for examinations and licenses, showing thereon, for each, the date of application, name, qualifications, place of business, place of residence, and whether the license was granted or not;

B. to receive all moneys derived for examination fees and remit same to department;

C. to call meeting of the council whenever the secretary deems the same to be necessary, or when requested by a majority of the council or by the commissioner;

D. to issue notices and summons to licensees, complaints and witnesses of hearings by the council on charges or violations of the law or the Code of Minimum Standards;

E. to issue notices to applicants for licenses of the time and place of examination;

F. to keep complete and detailed records of complaints and evidence pertaining thereto and have the same at hearings of the council thereon;

G. to furnish to the council such information in the secretary's possession as may be necessary for the proper performance of its duties or as it may from time to time require;

H. to prepare, with the advice and assistance of the council, a budget of expenses quarterly and transmit a copy thereof to the department;

I. to supervise the duties of inspectors and employees of the division and notify the council of any incompetence, misbehavior, or neglect of duty by them; and

J. to issue all licenses upon receipt of certification from the council, and approved by the commissioner, that the applicant has qualified and has successfully passed the examination. The secretary shall sign and issue renewals of licenses without such certification.

**Statutory Authority:** *MS s 175.171; 326.48*

**History:** *14 SR 1877; 17 SR 1279*

NOTE: This part is repealed effective December 1, 2007, by Laws 2007, chapter 140, article 13, section 3.

### 5230.0030 QUALIFICATIONS AND DUTIES OF INSPECTORS.

Inspectors shall be responsible for the fulfillment of their duties, which shall include the following:

A. They shall report to the secretary of the council or the department all violations of the law or Code of Minimum Standards, with recommendation for action on such violations.

B. They shall inspect the installation of all high pressure piping and appurtenances when requested or when deemed advisable to determine if such installation meets code requirements. They shall also inspect high pressure piping underground and overhead or in any building at any time to determine the safety operations of such piping and appurtenances.

C. They shall at all times be alert in ascertaining whether persons engaging in the business or occupation of high pressure piping are complying with the provisions of the registration act and Code of Minimum Standards, and especially as to whether or not such persons are licensed.

D. They shall be thoroughly conversant with all provisions of the registration act, the Code of Minimum Standards, and these rules.

E. They shall at all times be courteous in the conduct of their duties and shall acquaint the persons engaged in the business of high pressure piping with the provisions of the registration act and Code of Minimum Standards.

F. They shall be furnished with a badge or certificate of identification and shall display the same whenever requested when on duty.

G. They shall refrain from debating any question of disputes where violations are found, but shall be empowered to inform violators of the provisions of the code.

H. They shall not divulge any of their opinions or findings pertaining to their duties as inspectors to any person not connected with the Division of Pipefitting Standards unless instructed to do so by their superior officers, nor shall they divulge to the public any matters of a private nature in the possession of the division.

I. They shall not have authority to start any action or legal proceeding pertaining to the enforcement of the registration act or Code of Minimum Standards unless instructed by their superior officers to do so.

J. They shall have authority to give notice to installers or the property owner by attaching a tag to the piping or equipment advising that the piping installation does not meet the Minnesota code requirements or that it was installed by persons not licensed to make such installation and that the equipment shall not be put into operation until the law and code are complied with and the tag removed by an authorized person.

**Statutory Authority:** *MS s 175.171; 326.48*

**History:** *14 SR 1877*

### 5230.0040 DEFINITIONS.

Subpart 1. **Contracting pipefitter.** A “contracting pipefitter” is any person engaged in the planning, superintending, and practical installation of high pressure piping and appurtenances, and otherwise lawfully qualified to construct high pressure piping installations and make replacements to existing plants, who is also qualified to conduct the business of high pressure piping installations and who is familiar with the laws, rules, and minimum standards governing same.

Subp. 2. **High pressure steam.** “High pressure steam” shall mean a pressure in excess of 15 pounds per square inch.

Subp. 3. **Journeyman pipefitter.** A “journeyman pipefitter” is any person other than a contracting pipefitter who as his or her principal occupation is engaged in the practical installation of high pressure piping and appurtenances in the employ of a contracting pipefitter.

Subp. 4. **Pipefitter trainee.** A “pipefitter trainee” is any person other than a contracting or journeyman pipefitter, whose principal occupation is learning and assisting in the installation of high pressure piping and appurtenances under the direct supervision of a licensed pipefitter.

**Statutory Authority:** *MS s 175.171; 326.48*

**History:** *14 SR 1877; 17 SR 1279*

NOTE: This part is repealed effective December 1, 2007, by Laws 2007, chapter 140, article 13, section 3.

### 5230.0050 LICENSING AND REGISTRATION REQUIREMENT.

No person, firm, corporation, or association shall engage in the business or work at the occupation of high pressure piping in Minnesota without first obtaining a license and being registered as a contracting or journeyman pipefitter, as the case may be, and no licensed contractor shall employ a journeyman pipefitter, to install high pressure piping unless the journeyman is a licensed pipefitter; and no person shall work as a pipefitter trainee without being registered as such, nor longer than four years without making application for examination and license as a journeyman pipefitter. No person shall work as an apprentice pipefitter without entering an agreement of apprenticeship approved by the division of voluntary apprenticeship, nor longer than four years without making application for examination and license as a journeyman pipefitter.

Licenses shall be granted as contracting or journeyman pipefitters upon proof of qualifications therefor as hereinafter provided.

An applicant for a contractor’s license to do business in the name of a firm or partnership shall be a bona fide member or employee of the firm or partnership. An applicant for a

contractor's license to do business in the name of a corporation shall be a regular employee or member in the corporation.

**Statutory Authority:** *MS s 16A.1285; 175.171; 326.46 to 326.521*

**History:** *14 SR 1877; 25 SR 992*

### 5230.0060 APPLICATIONS FOR REGISTRATION.

Subpart 1. **Contractor and journeymen licenses.** Application for a contractor's license and registration shall be made to the secretary of the Division of Pipefitting Standards at least 30 days prior to the next scheduled examination on blanks provided for that purpose by the division. Application for a journeyman's license shall be filed with the division at least ten days prior to the next examination. The council may waive the rule applying to journeyman examinations in emergency cases. If the statements made by the applicant in said application form indicate that the applicant possesses the necessary qualifications to take an examination, the secretary shall notify him or her of the time and place of examination. If, on examination, the applicant fully qualifies, the council shall so certify to the department, which shall thereupon issue to the applicant a license as a contracting or journeyman pipefitter, as the case may be, for the remainder of the calendar year. If an applicant fails to qualify at an examination, the council shall so certify to the secretary, who shall notify the applicant of failure to pass.

Subp. 2. **Reexamination.** Any applicant who fails to pass the first examination may be reexamined at the next regular examination of which the applicant is notified without the payment of another fee, but thereafter, all applications for reexamination shall be accompanied by the regular statutory fee.

**Statutory Authority:** *MS s 175.171; 326.48*

**History:** *14 SR 1877; 17 SR 1279*

NOTE: Subpart 2 is repealed effective December 1, 2007, by Laws 2007, chapter 140, article 13, section 3.

### 5230.0070 PIPEFITTER QUALIFICATIONS.

Applicants for license as a contracting pipefitter shall:

- A. be at least 21 years of age;
- B. possess sufficient education to read and comprehend blueprints, specifications, and terms of contracts, and to compute the cost of installing high pressure piping and equipment;
- C. have worked at the trade of pipefitting for at least five years;
- D. be examined as to their knowledge of high pressure pipefitting, the requirements of the laws and minimum standards for the installation of high pressure piping in the state of Minnesota, their ability to lay out a plan of high pressure piping, and their knowledge of the physics and mechanics applicable to high pressure piping;
- E. generally demonstrate to the council their fitness to properly, intelligently, and lawfully carry on the business of a contracting and employing pipefitter in the state of Minnesota;
- F. be of good moral character;
- G. pay an examination fee; and
- H. pass the required examination by at least 70 percent.

**Statutory Authority:** *MS s 175.171; 326.48*

**History:** *14 SR 1877*

### 5230.0080 JOURNEYMAN PIPEFITTER QUALIFICATIONS.

Applicants for license shall:

- A. be at least 20 years of age;
- B. possess sufficient education to read and comprehend blueprints and specifications for the installation of high pressure piping;
- C. be of good moral character;

D. have been a registered pipefitter trainee or journeyman pipefitter for at least four years;

E. pay an examination fee; and

F. pass the required examination by at least 70 percent.

**Statutory Authority:** *MS s 175.171; 326.48*

**History:** *14 SR 1877*

### 5230.0090 EXAMINATION OF APPLICANTS FOR LICENSES.

Subpart 1. **Contents.** Examinations shall consist of written or oral questions and drawings of plans and sketches, except that when an applicant is disabled for a written examination, the examination may be entirely oral. All questions and sketches shall pertain to practical experience and knowledge of pipefitting and be standard, but may be changed from time to time.

Subp. 2. **Grading.** Examination papers shall be reviewed by at least two members of the council. Each answer or sketch shall be graded on the basis of 100 for perfect. The council may grant up to ten percent for experience in the trade or to persons who are certified welders based upon actual experience on high pressure pipefitting as shown on the application. An average of at least 70 percent shall constitute the passing mark.

Subp. 3. **Test results.** Applicants shall be notified of the outcome of their examination after their papers have been graded. The notice to those who failed to pass shall inform them of their privilege of reexamination without the payment of another fee at the next examination held of which they are notified.

**Statutory Authority:** *MS s 175.171; 326.48*

**History:** *14 SR 1877; 17 SR 1279; L 2005 c 56 s 2*

### 5230.0100 FEES.

Subpart 1. **General.** Fees shall be for the examination and to cover the cost of a license for the remainder of the calendar year in which the examination is taken or for which the application is made if the applicant qualifies for a license.

Subp. 2. **Application for renewal.** A license that has expired within one year of application for renewal may be renewed without an examination on filing an application for renewal with the department, accompanied by the fee required in this part. An application for renewal received by the department more than 30 days after the expiration date of the license must be accompanied by the late fee in subpart 3, item G.

If a license holder has failed to submit an application for renewal within one year of the date of the expiration of the license, renewal is not allowed unless the applicant files the application, pays the fee required by this part, and passes the examination required by this chapter.

A license holder may obtain an inactive license by filing the renewal application, paying the fee required by this part, and not engaging in the business or work at the occupation of high pressure piping in Minnesota without first activating a license and being registered as a contracting or journeyman pipefitter. A license holder with an inactive license must pay the renewal fee required by this part to activate a license.

Subp. 3. **Examination and license.** The fees for examination and license are as follows:

- A. journeyman pipefitter individual competency examination and license, \$100;
- B. renewal of journeyman pipefitter individual competency license, \$60;
- C. contracting pipefitter individual competency examination and license, \$250;
- D. renewal of contracting pipefitter individual competency license, \$220;
- E. high pressure pipefitting business license, \$350;
- F. inactive contracting pipefitter and journeyman pipefitter individual competency license, \$30; and
- G. late fees:

- (1) contracting pipefitter individual competency license, \$250;
- (2) journeyman pipefitter individual competency license, \$90;
- (3) high pressure pipefitting business license, \$380; and
- (4) inactive journeyman or contracting pipefitter individual competency license, \$60.

Payment of examination and license fees must accompany the application. There will be no refund of fees paid.

Subp. 3a. **High pressure pipefitting business license procedure.** To obtain a high pressure pipefitting business license, as required by Minnesota Statutes, section 326.48, subdivision 2, an applicant must submit a form approved by the department and signed by the applicant. The application shall include the applicant's certification that the applicant has:

- A. workers' compensation insurance required by law or that the applicant is exempt;
- B. public liability insurance as required by Minnesota Statutes, section 326.48, subdivision 4; and
- C. a high pressure pipefitting business license performance bond that meets the requirements of Minnesota Statutes, section 326.48, subdivision 3, including that the bond is in favor of the state of at least \$15,000 penal amount and is filed with the secretary of state.

With the application the applicant shall submit copies of the applicant's workers' compensation insurance certificate, if not exempt; the applicant's public liability insurance certificate; the applicant's high pressure pipefitting business license performance bond; and a check for the amount of the fee specified in subpart 3. The term of the high pressure pipefitting business license shall be a calendar year or the balance of the calendar year after application. High pressure pipefitting business licenses must be renewed annually on a calendar year basis.

A holder of a high pressure pipefitting business license must employ at least one full-time individual holding an individual contracting pipefitter competency license at all times. Only full-time employees who are licensed individual contracting pipefitters may obtain high pressure piping permits in the name of the high pressure pipefitting business licensee.

The high pressure pipefitting business licensee must notify the department within five business days after it last employed a licensed individual contracting pipefitter on a full-time basis. Upon ceasing to employ at least one individual contracting pipefitter competency license holder on a full-time basis, the business license holder must reemploy at least one individual contracting pipefitter competency license holder on a full-time basis within 60 calendar days of the cessation to retain its business license without reapplication. If the business license holder does not reemploy an individual contracting pipefitter competency license holder within 60 days of the cessation, the high pressure pipefitting business license shall lapse.

Subp. 4. **Permit to construct or install power piping, ammonia refrigeration systems, or anhydrous ammonia piping which form a part of a refrigeration, liquification, process, or manufacturing system.** A person, firm, or corporation that constructs or installs power piping, anhydrous ammonia, or ammonia refrigeration systems must file an application for a permit with the Department of Labor and Industry, or with a municipality that is authorized by law to issue that type of permit, before beginning construction or installation. The department's fees for a permit to construct or install power piping, anhydrous ammonia, or ammonia refrigeration systems are:

- A. filing fee (application for permit), \$50; and
- B. when filed prior to the start of construction or installation, an inspection fee of \$100, plus 0.020 of the first \$1,000,000, plus 0.010 of the next \$2,000,000, plus 0.0005 of the amount over \$3,000,000 of the cost of constructing or installing the power piping, anhydrous ammonia, or ammonia refrigeration systems as defined under part 5230.0260 and Minnesota Statutes, section 326.461, subdivision 2; or
- C. when filed after the start of construction or installation, an inspection fee of \$100 plus 0.030 of the first \$1,000,000, plus 0.015 of the next \$2,000,000, plus 0.000725 of the amount over \$3,000,000 of the cost of constructing or installing the power piping, anhy-

drous ammonia, or ammonia refrigeration systems as defined under part 5230.0260 and Minnesota Statutes, section 326.461, subdivision 2, or \$1,000, whichever is greater. The department shall consider any extenuating circumstances that may cause a permit application to be filed after the start of construction before requiring payment of the higher permit fee.

**Subp. 5. Permit payment alternatives.** The department shall make the following alternatives available for payment of permit applications:

A. a lump-sum payment at the time the permit application is submitted to the department;

B. quarterly payments based on the actual cost of labor and materials incurred that quarter to construct or install the power piping, anhydrous ammonia, or ammonia refrigeration systems; and

C. an annual payment based on the actual cost of labor and materials incurred to construct or install the power piping, anhydrous ammonia, or ammonia refrigeration systems. This payment method is only available under those circumstances where a licensed high pressure piping business does continuous high pressure piping work at a single work site. A log of work completed, with the cost of labor and materials, shall be maintained and provided to the department at inspection and with final payment. A nonrefundable \$300 payment shall be made, in addition to the application filing fee, to the department when requesting this permit payment alternative.

The department shall not accept any applications for permits from any parties that are in arrears on their permit payments. The department shall revoke any approved permit where payments are 60 days in arrears.

**Subp. 6. Pipefitter trainee registration fee.** The annual fee for registration of a pipefitter trainee is \$50. An application for renewal received by the department more than 30 days after the expiration date must be accompanied by the annual fee and a \$30 late fee. The pipefitter trainee's registration shall become immediately inactive and suspended the day after the expiration date of the license if the pipefitter trainee's registration is not renewed, and shall remain inactive and suspended until the registration is renewed.

**Statutory Authority:** *MS s 16A.128; 16A.1285; 175.171; 183.44; 183.545; 326.46 to 326.521*

**History:** *9 SR 2008; 12 SR 1148; 15 SR 2492; 18 SR 31; 21 SR 1245; 25 SR 992*

NOTE: Subparts 1, 3, and 4 are repealed effective December 1, 2007, by Laws 2007, chapter 140, article 13, section 3.

**5230.0110** Subpart 1. [Repealed, 14 SR 1877; 25 SR 992]

Subp. 2. [Repealed, 14 SR 1877; 25 SR 992]

Subp. 2a. [Repealed, 25 SR 992]

Subp. 3. [Repealed, 25 SR 992]

### **5230.0115 PIPEFITTER TRAINEES.**

Subpart 1. **Trainee qualifications.** A person learning the trade of pipefitting shall be registered with the department and meet the following criteria:

A. be at least 18 years of age;

B. possess sufficient education to learn how to read and comprehend blueprints and specifications for the installation of high pressure piping;

C. be employed by a licensed high pressure pipefitting business;

D. learn the trade of pipefitting pursuant to a training program on file with the department; and

E. pay the registration fee.

**Subp. 2. Registration.** A licensed high pressure piping business shall register pipefitting trainees with and pay the registration fee to the department before the pipefitter trainee may participate in the construction or installation of high pressure piping. The pipefitter trainee shall be registered on a form prescribed by the commissioner. The pipefitter trainee must sign the registration form. Registration of a pipefitter trainee shall be renewed annually,



provided the registration renewal fee is paid and the pipefitter trainee is making progress toward becoming a licensed journeyman pipefitter.

**Subp. 3. Training program.** A registered pipefitter trainee shall learn the trade of pipefitting pursuant to a training program established and maintained by the high pressure piping business. The high pressure piping business shall submit an outline of the training program to the department and must include information on the supervision of a trainee and the work processes to be learned by the pipefitter trainee. The training program must describe how the pipefitter trainee will be supervised consistent with subpart 4, and shall document the hours of work or training in the work processes participated in by the pipefitter trainee on the job and in the classroom. The training program must be signed by the licensed high pressure piping business contracting pipefitter and the pipefitter trainee.

**Subp. 4. Direct supervision.** A pipefitter trainee learning and assisting in the construction, replacement, and installation of high pressure piping shall be under the direct supervision of a licensed journeyman or contracting pipefitter. "Direct supervision" means the pipefitter trainee and the licensed pipefitter are on the same job site and working in close proximity and according to the training program filed with the department.

**Subp. 5. Completion of training.** The pipefitter trainee shall make application for examination and license as a journeyman pipefitter upon completion of four years of employment and training in the construction and installation of high pressure piping. Renewal of a pipefitter trainee registration shall be denied after five years unless the high pressure piping business can present good cause for renewing the pipefitter trainee registration.

**Subp. 6. Changes in address.** The licensed high pressure piping business or contracting pipefitter shall immediately notify the department of a change in address of the registered pipefitter trainee.

**Subp. 7. Trainee registration fee.** The licensed high pressure piping business shall pay the pipefitter trainee registration fee to the department.

**Subp. 8. Registration card.** The department shall issue to each registered pipefitter trainee a wallet card that shall at all times be in the possession of the registered pipefitter trainee during business hours and shall be displayed when required by a representative of the Division of Pipefitting Standards or the department. The registration card shall include, at a minimum, the pipefitter trainee's name, registration number, and employer's name. The registration card shall at no time be in the possession of any person other than the registered pipefitter trainee to whom it was issued. Registration cards are not transferable.

**Subp. 9. Apprentices exempt.** A high pressure pipefitting apprenticeship program approved by the department's voluntary apprenticeship division pursuant to Minnesota Statutes, section 178.08, and its apprentices are exempt from this part and are not required to separately register apprentices as trainees, pay the trainee registration fee, file the training program, or meet the other requirements of this part.

**Statutory Authority:** *MS s 16A.1285; 175.171; 326.46 to 326.521*

**History:** *25 SR 992*

#### 5230.0120 RIGHTS OF LICENSED CONTRACTING PIPEFITTER.

A contracting pipefitter's license shall entitle the pipefitter to work as a journeyman pipefitter under rules applicable to journeyman pipefitters, but a journeyman pipefitter's license shall not entitle the holder thereof to do business as a contracting pipefitter.

**Statutory Authority:** *MS s 175.171; 326.48*

**History:** *14 SR 1877; 17 SR 1279*

#### 5230.0130 DUTIES OF LICENSED CONTRACTING PIPEFITTERS.

A contracting pipefitter employing a journeyman pipefitter or a pipefitter trainee shall comply with all the laws, rules, and minimum standards of the state of Minnesota, paying promptly for labor and material furnished an owner, and reporting income tax and conforming to the laws governing the relationship of master and servant, including the carrying of workers' compensation insurance, paying the Social Security tax, paying wages when due,

furnishing written contracts of employment, and employing licensed pipefitters on high pressure pipe work.

**Statutory Authority:** *MS s 175.171; 326.48*

**History:** *14 SR 1877; 17 SR 1279*

#### **5230.0140 DISPLAY OF LICENSES.**

All certificates of licenses of a contracting pipefitter shall be posted in a conspicuous place in the office of the contractor's place of business and license cards issued to persons shall at all times be in possession of the licensee during business hours and shall be displayed when required by a representative of the Division of Pipefitting Standards or the department. Such card shall at no time be in the possession of any other person than the licensee to whom it was issued. Licenses issued hereunder shall not be transferable.

**Statutory Authority:** *MS s 175.171; 326.48*

**History:** *14 SR 1877*

#### **5230.0150 RIGHT TO DO BUSINESS.**

The right of any firm, corporation, or association to do business under a license issued to a member thereof shall depend upon the holder's active continuance in the business of such firm, corporation, or association.

**Statutory Authority:** *MS s 175.171; 326.48*

#### **5230.0160 SEVERANCE OF LICENSEE.**

If the member of a firm, corporation, or association holding a license for it shall sever that connection with such concern, the concern shall have no right to continue the business of high pressure pipefitting without procuring another license.

**Statutory Authority:** *MS s 175.171; 326.48*

**History:** *14 SR 1877; 17 SR 1279*

#### **5230.0170 CHANGES AND TRANSFERS OF LICENSE.**

Changes in the name or place of business of a firm, corporation, or association for which an individual is holding a license and the removal of the residence of a licensed journeyman from one city to another shall be reported immediately to the secretary of the Division of Pipefitting Standards by the licensee.

**Statutory Authority:** *MS s 175.171; 326.48*

**History:** *14 SR 1877*

#### **5230.0180 SURRENDER OF LICENSE UPON REVOCATION.**

When a pipefitter's license is revoked, the licensee shall at once surrender the certificate and identification card to the secretary of the Division of Pipefitting Standards.

**Statutory Authority:** *MS s 175.171; 326.48*

**History:** *14 SR 1877; 17 SR 1279*

#### **5230.0190 DUPLICATE LICENSES.**

Duplicate licenses and identification cards may be issued by the secretary upon proof that the original is lost or mutilated.

**Statutory Authority:** *MS s 175.171; 326.48*

#### **5230.0200 AUTOMATIC REINSTATEMENT.**

When a license has for any cause been suspended for a stated time, it shall automatically be again in force on the expiration of the period of suspension if such period is within the time for which the license was issued; provided, that if the cause for suspension has been adjusted in a manner satisfactory to the council, it may recommend to the department a reduction of the period of suspension or immediate reinstatement of the license.

**Statutory Authority:** *MS s 175.171; 326.48*

**5230.0210 RENEWAL AFTER REVOCATION.**

When a license has for any cause been revoked, it cannot be renewed without the procedure for an original license; provided, that where a license has been revoked for some cause other than incompetency the department may in its discretion waive the requirement of an examination if an application for a new license is made within one year from the date of revocation, but not thereafter.

**Statutory Authority:** *MS s 175.171; 326.48*

**CODE FOR POWER PIPING SYSTEMS****5230.0250 PURPOSE.**

This code prescribes minimum requirements for design, manufacture, test, and installation of power piping systems, as defined below, for steam generating plants, central heating plants, industrial plants, and district heating.

**Statutory Authority:** *MS s 326.46*

**5230.0260 SCOPE.**

“Power piping systems” shall be understood to include all steam piping and the component parts such as pipe, flanges, bolting, gaskets, valves, and fittings, within or forming a part of the above-mentioned plants, including central and district heating steam or hot water distribution piping away from the plant, building heating piping when the pressure exceeds 15 psi gage for steam, or 30 psi gage for hot water and a temperature exceeding 250 degrees Fahrenheit, whether the piping is installed underground or elsewhere.

Valves, fittings, and piping for boilers, as prescribed in the ASME Code for Power Boilers, are within the scope for this code but provisions of the ASME Code for Power Boilers shall govern where they exceed corresponding requirements of this code.

Economizers, heaters, tanks, and other pressure vessels are outside the scope of this code, but connecting piping shall conform to the requirements herein specified.

**Statutory Authority:** *MS s 326.46*

**5230.0270 REFERENCES TO STANDARDS AND SPECIFICATIONS.**

Unless otherwise specified, reference to an “American Standard,” in this code is to the latest revision of that standard as approved by the American Standards Association. The use of the latest revisions of all other standards or specifications mentioned in this code is intended.

The policy of the sectional committee in making reference to standards and specifications is stated in part 5230.1120, subpart 4.

**Statutory Authority:** *MS s 326.46*

**5230.0280 REQUIRED COMPLIANCE.**

The standards and specifications cited herein are minimum requirements. Dimensions and materials, unless otherwise specified, shall comply with these standards and specifications.

**Statutory Authority:** *MS s 326.46*

**5230.0290 MINIMUM CONSTRUCTION STANDARD.**

Construction shall be equal to or better than required by this code. Materials shall have physical and chemical properties at least equal to its minimum requirements.

**Statutory Authority:** *MS s 326.46*

**5230.0300 DIMENSION GUIDE.**

Adherence to American Standard dimensions is strongly recommended wherever practicable. However, other designs of at least equal strength and tightness and capable of withstanding the same hydrostatic test requirements may be used.

**Statutory Authority:** *MS s 326.46*

**5230.0310 PRESSURES AND TEMPERATURES.**

All pressures referred to in this code, unless otherwise stated, are expressed in pounds per square inch above atmospheric pressure, i.e., psi gage. All temperatures, unless otherwise stated, are the metal temperatures of the respective materials.

**Statutory Authority:** *MS s 326.46*

**5230.0320 MATERIALS.**

Subpart 1. **Minimum requirement.** The materials used shall be capable of meeting the physical and chemical requirements and tests of the respective specifications in Table 1 of ASA B31.1–1955 Code for Pressure Piping. Any materials allowed under this code shall not be used for service in excess of pressures and temperatures herein specified except as noted.

Subp. 2. **Future materials.** Should it be desired to use any materials or methods of manufacture not now covered by this code or which may be developed in the future, it is intended that the manufacturer shall provide details of design and construction which will be as safe as otherwise provided by the rules in the code. Where it is desired to use materials not included in Table 1, written application shall be made to the department fully describing the proposed material and the contemplated use, requesting that an allowable stress (S value) be assigned. Such materials shall not be used until the stress values have been approved.

**Statutory Authority:** *MS s 326.46*

**5230.0330 TABLE 1 DEFINED.**

“Table 1” refers to American Standard Code for Pressure Piping and is not printed in this code book.

**Statutory Authority:** *MS s 326.46*

**5230.0340 FLANGES.**

The dimensions and drilling for all line or end flanges shall conform to the requirements of the B16 series of the American Standards for cast iron, steel, and bronze material for the respective pressures and temperatures as stated in the specific requirements of parts 5230.0570, 5230.0660, 5230.0670, and 5230.0770. For marking of flanges, see this code.

**Statutory Authority:** *MS s 326.46*

**5230.0350 VALVES.**

It is mandatory that valves be:

A. of the design or equal to the design which the manufacturer thereof recommends for the service; and

B. of materials allowed by the code for the pressure and temperature.

Body metal thickness of steel valves shall not be less than that required by American Standard for Steel Pipe Flanges and Flanged Fittings, ASA B16.5. Each valve, of a size permitting, shall bear the maker’s name or trademark and reference symbol to indicate the service conditions for which the maker guarantees it. See also part 5230.1120, subpart 2.

All screw–end valves shall be threaded according to the American Standard for Taper Pipe Threads (B2.1). Flanged–end valves shall have connecting–end flanges conforming to the B16 series of American Standards for cast iron, steel, and bronze corresponding to the maximum pressure and service for which the valve is to be used. Face–to–face dimensions shall comply with B16.10 for types of valves covered in the standard. Welding–end valves may be used if welded directly into the line in accordance with part 5230.1070. It is recommended that the ends be prepared in accordance with details shown therein.

**Statutory Authority:** *MS s 326.46*

**5230.0360 PRESSURE–REDUCING AND RELIEF VALVES.**

Subpart 1. **Location of valves.** Where pressure–reducing valves are used, one or more relief or safety valves shall be provided on the low–pressure side of the reducing valve in case the piping or equipment on the low–pressure side does not meet the requirements for the full initial pressure. The relief or safety valve shall be located adjoining or as close as possible to

the reducing valve. Proper protection shall be provided to prevent injury or damage caused by escaping fluid or steam and in compliance with part 5230.0970, subpart 3, item C.

Subp. 2. **Hand-controlled bypasses.** The use of hand-controlled bypasses around a reducing valve is permissible provided the bypass does not have a greater capacity than the reducing valve and the low-pressure side is adequately protected by relief valves.

Subp. 3. **Dimensions and materials.** The flange dimensions, wall thickness, and material of reducing and relief valves shall conform to the requirements specified herein for valves and fittings for the pressures and temperatures to which they may be subjected.

Subp. 4. **Pressure gage installation.** It is mandatory that a pressure gage be installed on the low-pressure side of a reducing valve. Where two or more reducing valves are installed in series, a pressure gage shall be installed on the low-pressure side of each pressure-reducing valve.

Subp. 5. **Exhaust and pump suction lines.** Exhaust and pump suction lines for any service and pressure shall have relief valves of suitable size unless the lines and attached equipment are designed for the maximum pressure to which they may accidentally or otherwise be subjected, or unless a suitable alarm indicator, such as a free-blowing relief valve is installed where it will warn the operator of such equipment.

**Statutory Authority:** *MS s 326.46*

#### 5230.0370 FITTINGS.

The minimum metal thickness of all flanged or screwed fittings and the strength of factory-made welding fittings shall not be less than that specified for the pressures and temperatures in the respective American Standards. For markings on fittings, see part 5230.1120, subpart 2.

**Statutory Authority:** *MS s 326.46*

#### 5230.0380 SPECIAL FITTINGS.

Where special screwed or flanged fittings are required to overall dimensions differing from those of the regular shapes specified in the American Standards referred to, they shall conform to these standards with respect to minimum wall thickness and flange dimensions, if flanged, and to the specific requirements of this section of the code. They shall be designed to withstand the hydrostatic test pressures as specified in part 5230.0500. All material shall conform to the requirements given herein for the particular pressure and temperature rating.

Special welded steel fittings such as elbows, tees, etc., may be used if they comply with the requirements of section 6 of this code. Fittings with welding ends may be used in accordance with the specific requirements of this part, parts 5230.0560, subpart 3; 5230.0600, subpart 2; 5230.0760, subpart 2; or 5230.0860, subpart 2 regarding the service intended.

**Statutory Authority:** *MS s 326.46*

#### 5230.0390 BOLTING.

Subpart 1. **Standards.** The following standards shall apply to bolting:

A. For steam service pressure in excess of 250 psi or for steam or water service temperature exceeding 450 degrees Fahrenheit, the bolting material shall conform to ASTM Specification A 193.

B. For temperatures exceeding 750 degrees Fahrenheit only bolt-studs are recommended.

C. When cast iron flanges are used, bolting material shall be of carbon steel conforming to ASTM Specification A 307, Grade B, or A 107, Grade 1120, except as otherwise permitted in part 5230.1050, subpart 4.

Subp. 2. **Flange bolts or bolt-studs.** Flange bolts or bolt-studs shall be of the dimensions and material specified for the purpose in the corresponding American flange standards. Bolts or bolt-studs shall extend completely through the nuts and, if desired, may have reduced shanks of a diameter not less than the diameter at root of threads.

Subp. 3. **Carbon steel bolts.** Carbon steel bolts may be American Standard regular square or heavy hexagon bolts and shall have American Standard heavy semifinished hexagonal nuts (B18.2).

Subp. 4. **Alloy steel bolt–studs.** Alloy steel bolt–studs may be threaded at both ends or full length, or American Standard (B18.2) heavy semifinished hexagon bolts may be used. They shall have American Standard heavy semifinished hexagonal nuts (B18.2). It is recommended that all bolts or bolt–studs and accompanying nuts intended for high–temperature service be threaded in accordance with American Standard B1.1, Class 2A external threads, Class 2B internal threads.

Subp. 5. **Nuts.** Nuts shall be American Standard heavy semifinished hexagonal (B18.2) and shall be threaded as indicated herein. Nuts shall conform to ASTM Specification A194. Nuts cut from bar stock so that their axes will be parallel to the direction of rolling of the bar may be used in all sizes for joints in which one or both flanges are cast iron; they shall not be used for joints in which both flanges are steel except for nut sizes one–half inch and smaller, which are permissible in any case.

Subp. 6. **Washers.** Washers, when used under nuts, shall be of forged or rolled steel.

**Statutory Authority:** *MS s 326.46*

#### **5230.0400 PIPE THREADS.**

All pipe threads on pipes, valves, fittings, etc., shall conform to the American Standard for Taper Pipe Threads B2.1.

**Statutory Authority:** *MS s 326.46*

#### **5230.0410 PIPE JOINTS.**

Pipe joints shall comply with fabrication rules and details in part 5230.1050, subpart 4.

**Statutory Authority:** *MS s 326.46*

#### **5230.0420 SUBSTITUTE REQUIREMENTS.**

Qualification of welding procedures and welders under Section IX of the ASME Boiler and Pressure Vessel Code is acceptable in lieu of the requirements of part 5230.1070.

**Statutory Authority:** *MS s 326.46*

#### **5230.0430 GASKETS.**

Gaskets, where required, shall be of a material that resists attack by the fluid carried in the pipe line, shall be strong enough to hold the pressure, and perform the purpose intended throughout the temperature range encountered. Gaskets shall be as thin as the finish of surfaces will permit to reduce possibility of blowing out.

For all lines under pressure and above 250 degrees Fahrenheit the gaskets shall be metallic, asbestos, or other nonburning material. For further details concerning gaskets, refer to part 5230.1050, subpart 5.

**Statutory Authority:** *MS s 326.46*

#### **5230.0440 THERMAL EXPANSION.**

Thermal expansion of piping shall be provided for preferably by pipe bends, offsets, or changes in direction of the pipe line itself. Where pipe bends or offsets are used or where the pipe line direction is changed to provide for expansion, the provisions of part 5230.1060, subpart 5 shall be followed.

Expansion joints of either the slip–sleeve or swivel types may be used if: their materials conform to this code, their structural and working parts are of ample proportions, and for pressures above 15 psi, the design prevents complete disengagement of the working parts while in service.

Nonreinforced corrugated copper expansion joints shall not be used for steam pressures exceeding 25 psi. Corrugated copper expansion joints when reinforced with exterior rings or sleeves may be used for steam pressures not exceeding 200 psi.

Nothing in this part shall be construed to limit using expansion joints, corrugated pipe, or creased, corrugated, wrinkled, or plain bends made of the same material as the remainder of the pipe, or of other material suitable for the pressure and temperature conditions.

**Statutory Authority:** *MS s 326.46*

**5230.0450 HANGERS, SUPPORTS, AND ANCHORS.**

Piping and equipment shall be supported in a thoroughly substantial and workmanlike manner, rigid enough to prevent excessive vibration, and anchored sufficiently to prevent undue strains on boilers and equipment served. Hangers, supports, and anchors shall be made of durable materials. In tunnels and buildings of permanent fireproof construction, these materials shall be noncombustible. In buildings of nonfireproof construction, piping may be supported on or hung from wood structures if all piping used for conveying fluid at temperatures above 250 degrees Fahrenheit is spaced or insulated from such wooden members to prevent dangerous heating.

Hangers and supports shall permit free expansion and contraction of the piping between anchors. All piping shall be carried on adjustable hangers or properly leveled supports, and suitable springs, sway bracing, vibration dampeners, etc., shall be provided where necessary.

Pipe hangers, supports, anchors, etc., shall be designed and fabricated to comply with part 5230.1030.

**Statutory Authority:** *MS s 326.46*

**5230.0460 PIPE SLEEVES.**

Where steam pipes pass through walls, partitions, floors, beams, etc., constructed of combustible material, protecting metal sleeves or thimbles shall be provided to give a clearance of not less than one-fourth inch under hot and cold conditions all around the pipe, or pipe and covering. When steam pipes pass through metal partitions, etc., a clearance of at least one-fourth inch under hot and cold conditions shall be left all around the pipe, or pipe and covering. In any case, if the fluid temperature exceeds 250 degrees Fahrenheit, the pipe shall be insulated inside the sleeves with a covering of at least standard thickness.

Walls, floors, partitions, beams, etc., shall not be cast solidly to or built up around and in contact with a steam, hot water, or hot oil pipe. Where such pipe must be installed in a concrete floor or other building member, it shall be protected for the entire buried length with a suitable protecting pipe sleeve of steel, cast iron, wrought iron, or tile; exception may be taken to the preceding rules where pipes pass through walls, floors, partitions, etc., that must be kept watertight.

**Statutory Authority:** *MS s 326.46*

**5230.0470 DRAINS, DRIPS, AND STEAM TRAPS.**

**Subpart 1. Requirement.** Suitable drains or drips shall be provided wherever necessary to drain the condensate from all sections of the piping and equipment wherever it may collect. Suitable drains shall also be provided to empty water lines, water storage tanks, equipment containing water, etc., when such piping and equipment is out of service. At least one valve shall be placed in each drip or drain line.

**Subp. 2. Proper drainage.** Drip lines from steam headers, mains, separators, and other equipment shall be properly drained by traps installed in accessible locations and below the level of the apparatus drained. Drip pumps, drip tanks, and open discharge drips (preferably with orifice control) may be used in lieu of traps, if they are safely installed, protected, and operated under regular supervision. All drain lines shall have drip valves for free blow to the atmosphere.

**Subp. 3. Connections.** Drip lines from steam headers, mains, separators, or other equipment operating at different pressures shall not be connected to discharge through the same trap. Where several traps discharge into one header which is or may be under pressure, a stop valve and a check valve shall be placed in the discharge line from each trap.

**Subp. 4. Trap discharge piping.** Trap discharge piping shall have the same thickness as the inlet piping unless it is vented to atmosphere or operated under low pressure and has no stop valves. The trap discharge piping shall have at least the pressure rating of the maximum discharge pressure to which it may be subjected. Trap discharge piping shall be protected against freezing where necessary. Drainage from steam traps, if open to the atmosphere, shall be safeguarded to prevent accidents from hot discharge.

# MINNESOTA RULES 2007

1005

PIPEFITTERS; POWER PIPING SYSTEMS 5230.0520

Subp. 5. **Trap discharge.** The discharge of a high pressure trap shall not empty into a low pressure receiver unless first run through a flash tank or there is an ample sized vent so a trap failure could not increase the pressure in low pressure receiver tank.

**Statutory Authority:** *MS s 326.46*

## 5230.0480 INSPECTION AND TESTS.

All material shall be capable of meeting the inspection and test requirements described in the corresponding specification listed in Table 1 of ASA B31.1-1955. Unless otherwise specified by the purchaser, the manufacturer's certification that these tests have been met shall be accepted.

**Statutory Authority:** *MS s 326.46*

## 5230.0490 CLEANING.

The inside of all pipes, valves, and fittings shall be smooth, clean, and free from blisters, loose mill scale, sand, and dirt when erected. All lines should be cleaned after installation and before placing in service.

**Statutory Authority:** *MS s 326.46*

## 5230.0500 HYDROSTATIC TESTS.

Subpart 1. **Before erection.** All valves, fittings, etc. shall be capable of withstanding a hydrostatic shell test made before erection equal to twice the primary steam service pressure, except that steel fittings and valves shall be capable of withstanding the test pressures as given in the American Standard for Steel Pipe Flanges and Flanges Fittings ASA B16.5 for the specific material, pressure standard and facing involved (ring joint facing for welding ends). Pipe shall be capable of meeting the hydrostatic test requirements contained in the respective specifications in Table 1 ASA B31.1-1955, under which it was purchased.

Subp. 2. **After erection.** All piping systems shall be capable of withstanding a hydrostatic test pressure of one and one-half times the design pressure, except that the test pressure shall in no case exceed the adjusted pressure-temperature rating for 100 degrees Fahrenheit as given in the American Standard for Steel Pipe Flanges and Flange Fittings ASA B16.5 for the material and pressure standard involved. For systems joined wholly with welded joints the adjusted pressure rating shall be that for ring joint facing. For systems joined wholly or partly with flanged joints the adjusted pressure rating shall be that for the type of facing used.

The hydrostatic test after erection shall be applied wherever practicable and shall comply with part 5230.1070, subpart 10. In no case shall the test pressure be less than 50 psi nor shall it be made with a test medium having a temperature in excess of 100 degrees Fahrenheit.

**Statutory Authority:** *MS s 326.46*

## 5230.0510 THICKNESS OF PIPE.

For inspection purposes the minimum thickness of pipe wall required at different pressures and for temperatures shall not exceed those recommended by the manufacturer.

**Statutory Authority:** *MS s 326.46*

## 5230.0520 VARIATIONS IN PRESSURE AND TEMPERATURE.

Piping systems shall be considered safe for operation if the maximum sustained pressure and temperature on any part do not exceed the pressure and temperature allowed by this code, for all component parts of the system. It is recognized that occasional departures from the nominal operating pressure and temperature inevitably occur and therefore the piping system will also be considered safe for occasional operation for short periods at higher pressures and temperatures.

Either pressure or temperature, or both, may exceed the nominal design values if the computed stress in the pipe wall does not exceed the allowable S value for the expected temperature by more than the following allowances for the period of duration indicated:

A. up to 15 percent increase above the S value during 10 percent of the operating period;



B. up to 20 percent increase above the S value during one per cent of the operating period.

**Statutory Authority:** *MS s 326.46*

**SPECIFIC REQUIREMENTS; STEAM PRESSURES ABOVE 350 PSI  
AND NOT ABOVE 2,500 PSI AND TEMPERATURES NOT IN  
EXCESS OF 1,100 DEGREES FAHRENHEIT**

**5230.0550 VALVES.**

Subpart 1. **Nominal size.** All valves in nominal sizes three inches and smaller for pressures above 250 psi but not above 400 psi, two inches and smaller for pressures above 400 psi but not above 600 psi, and 1-1/2 inches and smaller for pressures above 600 psi may have screwed, flanged, or welding ends. Stem threads of gate, angle, and globe valves of above sizes may be internal or external with reference to the valve bonnet.

Subp. 2. **Larger sizes.** For all valves larger than sizes specified in subpart 1 flanged or welding ends shall be used. Stem threads of gate, angle, and globe valves shall be external with reference to the valve body and used with an outside yoke. Bonnet joints may be flanged, welded, or of other designs, except that screwed bonnet connections which depend upon the thread to make a tight joint are not permitted. Steam valves eight inches and larger shall have a bypass of at least three-fourths inch nominal size. Sizes of bypasses should be increased if required for mechanical strength or vibration. Pipe for bypasses shall be seamless steel of a material at least equal to that used for the line. Pipe lighter than Schedule 80 of ASA B36.10 shall not be used for bypasses. Bypasses may be integral or attached.

Subp. 3. **Valve qualities.** All valves shall be manufacturer's standard, or equal for the respective pressure and temperature and shall be steel, or nonferrous material as recommended by the manufacturer and as stipulated in this code for this pressure-temperature range. Malleable iron valves may be used for service pressures not over 300 psi and temperatures not over 500 degrees Fahrenheit. Flanges of steel flanged valves shall comply with the American Standard B16.5 for respective pressure and temperature.

**Statutory Authority:** *MS s 326.46*

**5230.0560 FITTINGS.**

Subpart 1. **Nominal sized fittings.** All fittings in nominal sizes above three inches for pressures above 250 psi but not above 400 psi, two inches for pressures above 400 psi but not above 600 psi, and 1-1/2 inches for pressures above 600 psi but not above 2,500 psi shall have flanged ends or welding ends.

Subp. 2. **Flanged fittings.** Flanged fittings shall conform to the American Standard B16.5 for dimensions and for pressure and temperature ratings and shall be of cast or forged steel, but nonferrous materials may be used subject to limitations under part 5230.0320.

Subp. 3. **Welding fittings.** Welding fittings shall comply with American Standard for Steel Butt-Welding Fittings ASA B16.9 or American Standard for Steel Socket-Welding Fittings ASA B16.11 where applicable, and the material shall conform to ASTM Specifications A 216, A 217, or A 234, or material conforming to the requirements of part 5230.0320. Special fittings or welded assemblies fabricated in shop or field shall conform to this code. The material of special welding fittings shall conform to ASTM Specifications A 216, A 217, or A 234, or to the requirements of part 5230.0320. Special fittings or welded assemblies shall be construed to embrace cast, forged, rolled, or extruded fittings of special dimensions, and built-up manifolds, segmental elbows, fabricated swages, orange-peel bull plugs, or any similar construction not covered by American Standards B16.9 or B16.11 for factory-made welding fittings.

Subp. 4. **Forged- or cast-steel screwed fittings.** Forged- or cast-steel screwed fittings are permitted in small nominal sizes up to and including three inches for pressures above 250 psi but not above 400 psi, two inches for pressures above 400 psi but not above 600 psi, and 1-1/2 inches for pressures above 600 psi but not above 2,500 psi if their design is suitable for the pressure and temperature. Malleable iron screwed fittings conforming to the

# MINNESOTA RULES 2007

1007

## PIPEFITTERS; POWER PIPING SYSTEMS 5230.0650

300–pound American Standard B16.19 may be used for pressures not over 300 psi if the temperature is not over 500 degrees Fahrenheit.

**Statutory Authority:** *MS s 326.46*

### 5230.0570 PIPE JOINTS.

Flanges and bolting shall conform to the American Standard B16.5 for respective pressures and temperatures. Unions shall be forged steel and suitable for the pressure or malleable iron to the AAR Specification M404. For joints other than welded, refer to part 5230.1050. Welded joints shall be constructed as detailed under part 5230.1070 and welding operators shall qualify according to part 5230.1080.

**Statutory Authority:** *MS s 326.46*

### 5230.0580 PIPE.

Subpart 1. **Pressures greater than 600 psi.** For pressures above 600 psi, the pipe shall be:

- A. seamless steel meeting ASTM Specifications A 106, A 312, A 335 or A 376; or
- B. forged and bored steel meeting A 369; or
- C. automatic welded steel meeting A 312; or
- D. electric–fusion–welded steel pipe meeting with ASTM Specification A 155.

Subp. 2. **Pressures greater than 250 psi.** For pressures above 250 psi, but not above 600 psi, pipe shall be:

- A. seamless steel in accordance with ASTM Specification A 106;
- B. electric–fusion–welded steel pipe in accordance with ASTM Specification A 155;
- C. electric–resistance–welded steel pipe of ASTM Specification A 135; or
- D. seamless or electric–resistance–welded steel pipe of ASTM Specification A 53.

Subp. 3. **Pressures less than 250 psi.** For service up to 750 degrees Fahrenheit and pressures of not over 250 psi, any of the following classes of pipe may be used:

- A. electric–fusion–welded steel pipe of ASTM Specification A 134, or A 139;
- B. electric–resistance–welded steel pipe of ASTM Specification A 135;
- C. seamless or welded steel pipe of ASTM Specification A 53; or
- D. wrought iron pipe of ASTM Specification A 72.

Pipe permissible for the service specified in subpart 3 may be used for temperatures higher than 750 degrees Fahrenheit, unless otherwise prohibited, if the S value in accordance with part 5230.0510 is used when calculating the pipe wall thickness.

**Statutory Authority:** *MS s 326.46*

### 5230.0590 PIPES FOR SPECIAL USES.

Grade A seamless steel pipe of ASTM Specification A 106, wrought iron pipe of ASTM A 72, Grade A seamless steel pipe of ASTM A 53, or Grade A electric–welded pipe of ASTM A 53, A 135, or A 139 shall be used for close coiling, cold bending, or other special uses.

**Statutory Authority:** *MS s 326.46*

### 5230.0600 OTHER PIPE PERMITTED.

Pipe meeting API Specification 5L may also be used. See part 5230.0320.

**Statutory Authority:** *MS s 326.46*

### 5230.0610 BOLTING.

Bolting shall conform to ASTM Specification A 193. Nuts shall conform to ASTM Specification A 194. See part 5230.0390.

**Statutory Authority:** *MS s 326.46*

## STEAM PRESSURES ABOVE 125 PSI AND NOT ABOVE 250 PSI AND TEMPERATURES NOT IN EXCESS OF 450 DEGREES FAHRENHEIT

### 5230.0650 VALVES.

Gate, angle, and globe valves three inches and smaller may have inside screw. All stop valves eight inches and over shall be bypassed. Pipe used in a bypass shall be of steel or

wrought iron. All gate valves larger than three inches shall have outside screw and yoke where clearance permits. Where clearance is insufficient, nonrising stem gate valves are permissible but it is recommended an indicator be required where lack of one would be a hazard.

All valves shall be manufacturer's standard or equal for the specified pressure and temperature. Bodies, bonnets, and yokes shall be of cast iron, malleable iron, steel, bronze, brass, nickel, or nickel alloy. Drilling and facing of flanges of flanged valves shall comply with American Standard B16b, B16.5 (for 150-pound steel), or B16.24 (for bronze).

**Statutory Authority:** *MS s 326.46*

#### 5230.0660 FITTINGS.

Subpart 1. **General requirement.** Fittings shall be of steel, cast iron, malleable iron, bronze, or brass.

Subp. 2. **Flanged steel fittings.** Flanged steel fittings shall conform to the requirements for 300-pound fittings in the American Standard B16.5, except that the 150-pound fittings conforming to the American Standard B16.5 may be used for the adjusted pressure-temperature ratings established therein.

Subp. 3. **Welding fittings.** Welding fittings shall comply with American Standard for Steel Butt-Welding Fittings (B16.9) or American Standard for Steel Socket-Welding Fittings (B16.11) where applicable, and the material shall conform to ASTM Specifications A 216, A 217, or A 234 or material conforming to the requirements of part 5230.0320. Special fittings or welded assemblies fabricated in shop or field shall conform to this code. The material of special welding fittings shall conform to ASTM Specifications A 216, A 217, or A 234, or to the requirements of part 5230.0320. Special fittings or welded assemblies shall be construed to embrace cast, forged, rolled, or extruded fittings of special dimensions, and built-up manifolds, segmental elbows, fabricated swages, orange-peel bull plugs, or any similar construction not covered by American Standards B16.9 or B16.11 for factory-made welding fittings.

Subp. 4. **Cast-iron fittings.** Flanged cast-iron fittings shall conform to the Class 250 American Standard B16b and may be used for the pressure and temperature ratings established therein. Screwed cast-iron fittings shall conform to the 250-pound American Standard B16.4.

Subp. 5. **Malleable iron fittings.** Screwed malleable iron fittings shall conform to the 300-pound American Standard B16.19 except that 150-pound malleable iron fittings conforming to the American Standard B16.3 may be used for pressures not in excess of 150 psi.

Subp. 6. **Brass or bronze fittings.** Flanged brass or bronze fittings shall conform to the 300-pound American Standard B16.24, except that 150-pound brass or bronze fittings conforming to B16.24 may be used for pressure not in excess of 150 psi.

Screwed brass or bronze fittings shall conform to the 250-pound American Standard B16.17.

**Statutory Authority:** *MS s 326.46*

#### 5230.0670 PIPE JOINTS.

Steel flanges and bolting shall conform to the 300-pound American Standard B16.5. Cast iron flanges shall conform to the Class 250 American Standard B16b for the pressure and temperature ratings established in the standard. Bronze flanges and bolting shall conform to the 150-pound and 300-pound American Standard B16.24 for the respective pressures and temperatures. The 150-pound American Standard B16.5 may be used if permitted by its table of adjusted pressure-temperature ratings. Unions shall be suitable for the pressure. For joints other than welded, refer to part 5230.1050, subpart 2. Welded joints shall be constructed as detailed under part 5230.1070 and welding operators shall qualify according to part 5230.1100.

**Statutory Authority:** *MS s 326.46*

#### 5230.0680 PIPE.

For pressures and temperatures within this specific requirement group, any of the following classes of pipe may be used:

# MINNESOTA RULES 2007

1009

## PIPEFITTERS; POWER PIPING SYSTEMS 5230.0760

- A. electric–fusion–welded steel pipe of ASTM Specification A 134, or A 139;
- B. electric–resistance–welded steel pipe of ASTM A 135;
- C. seamless or welded steel pipe of ASTM Specification A 53; or
- D. wrought iron pipe of ASTM Specification A 72.

Copper pipe or tubing and brass pipe may be used for this class of service provided the temperature is not above 406 degrees Fahrenheit.

Grade A seamless steel pipe of ASTM Specification A 53, or wrought iron pipe of ASTM Specification A 72, or Grade A electric–welded pipe of ASTM A 53, A 135, or A 139 shall be used for close coiling, cold bending, or other special uses.

The foregoing shall not exclude cast–iron pipe if it conforms to the specifications and pressure–temperature ratings in this section of the code.

Pipe permissible for the above service may be used for temperatures higher than 450 degrees Fahrenheit, unless otherwise prohibited, if an S value in accordance with part 5230.0510 is used.

Pipe meeting API Specifications 5L may also be used. See part 5230.0320.

**Statutory Authority:** *MS s 326.46*

### 5230.0690 BOLTING.

Bolting material shall be of steel. Carbon steel bolts and bolt–studs purchased under a definite specification may be able to resist calculated stresses for piping systems up to 250 psi and temperatures of 450 degrees Fahrenheit, but for pressures in excess of 160 psi, ASTM Specification A 193 is recommended for bolting material, except that where cast–iron flanges are used bolting material shall be of carbon steel. Nuts shall meet ASTM Specification A 194.

**Statutory Authority:** *MS s 326.46*

### STEAM PRESSURES ABOVE 25 PSI BUT NOT ABOVE 125 PSI AND TEMPERATURES NOT IN EXCESS OF 450 DEGREES FAHRENHEIT

### 5230.0750 VALVES.

All valves shall be manufacturer’s standard for the specified pressure and shall have cast–iron, malleable iron, steel, or brass bodies, bonnets, disks, and yokes. Drilling and facing of flanges of flanged valves shall conform with American Standard B16.1 or B16.24.

**Statutory Authority:** *MS s 326.46*

### 5230.0760 FITTINGS.

Subpart 1. **General requirement.** Fittings shall be of steel, cast iron, malleable iron, bronze, or brass.

Subp. 2. **Flanged steel fittings.** Flanged steel fittings shall conform to the requirements for 150–pound fittings in the American Standard B16.5.

Subp. 3. **Welding fittings.** Welding fittings shall comply with American Standard for Steel Butt–Welding Fittings (B16.9) or American Standard for Steel Socket–Welding Fittings (B16.11) where applicable, and the material shall conform to ASTM Specifications A 216, A 217, or A 234, or material conforming to the requirements of part 5230.0320. Special fittings or welded assemblies fabricated in shop or field shall conform to this code. The material of special welding fittings shall conform to ASTM Specifications A 216, A 217, or A 234, or to the requirements of part 5230.0320. Special fittings or welded assemblies shall be construed to embrace cast, forged, rolled, or extruded fittings of special dimensions, and built–up manifolds, segmental elbows, fabricated swages, orange–peel bullplugs, or any similar construction not covered by American Standards B16.9 or B16.11 for factory–made welding fittings.

Subp. 4. **Cast–iron fittings.** Flanged cast–iron fittings shall conform to the Class 125 American Standard B16.1 and may be used for the pressure and temperature ratings established therein. Screwed cast–iron fittings shall conform to the 125–pound American Standard B16.4.

**5230.0760 PIPEFITTERS; POWER PIPING SYSTEMS**

1010

Subp. 5. **Screwed malleable iron fittings.** Screwed malleable iron fittings shall conform to the 150-pound American Standard B16.3.

Subp. 6. **Brass or bronze fittings.** Flanged brass or bronze fittings shall conform to the 150-pound American Standard B16.24. Screwed brass or bronze fittings shall conform to the 125-pound American Standard B16.15.

**Statutory Authority:** *MS s 326.46*

**5230.0770 PIPE JOINTS.**

Steel flanges shall conform to the 150-pound American Standard B16.5. Cast-iron flanges and bolting shall conform to the Class 125 American Standard B16.1 for the pressure and temperature ratings established in the standard. Bronze flanges and bolting shall conform to the 150-pound American Standard B16.24. Unions shall be suitable for the pressure and temperature. For joints other than welded refer to part 5230.1050, subpart 2. Welded joints shall be constructed as detailed under part 5230.1070. Welding operators shall qualify according to part 5230.1070. Cast-iron pipe joints may be welded with bronze, nickel, or nickel alloy, or 18 Cr-8 Ni electrodes, if the temperature is not over 353 degrees Fahrenheit.

**Statutory Authority:** *MS s 326.46*

**5230.0780 PIPE.**

Pipe shall be of steel, wrought iron, cast iron, copper, or brass subject to the limitations given in part 5230.0510. Steel pipe meeting ASTM Specification A 120 may be used except for close coiling or bending.

**Statutory Authority:** *MS s 326.46*

**5230.0790 BOLTING.**

Bolting material shall be of carbon steel or wrought iron threaded in accordance with American Standard for Screw Threads B1.1, coarse thread series.

**Statutory Authority:** *MS s 326.46*

**STEAM PRESSURES 25 PSI AND BELOW AND TEMPERATURES  
NOT IN EXCESS OF 450 DEGREES FAHRENHEIT****5230.0850 VALVES.**

All valves shall be of the manufacturers' standard for 25 psi pressure and shall have cast-iron, malleable iron, or brass bodies, bonnets, disks, and yokes. Flanges of flanged valves shall conform to the 25-pound American Standard B16B2 for pipe sizes four inches and above and to the 125-pound American Standard B16.1 for sizes under four inches, or to American Standard B16.24.

**Statutory Authority:** *MS s 326.46*

**5230.0860 FITTINGS.**

Subpart 1. **Minimum requirements.** For minimum requirements fittings shall be of cast iron, malleable iron, or other material allowed under this code.

Subp. 2. **Cast iron.** Flanged cast-iron fittings shall conform to the 25-pound American Standard B16b2. Screwed cast-iron fittings shall conform to the 125-pound and 250-pound American Standard B16.4.

Subp. 3. **Malleable iron.** Screwed malleable iron fittings shall conform to the 150-pound American Standard B16.3.

Subp. 4. **Brass or bronze.** Screwed brass or bronze fittings shall conform to the 125-pound American Standard B16.15.

Subp. 5. **Steel.** Welding fittings shall comply with American Standard for Steel Butt-Welding Fittings B16.9 or American Standard for Steel Socket-Welding Fittings B16.11 where applicable, and the material shall conform to ASTM Specifications A 216, A 217, or A 234, or material conforming to the requirements of part 5230.0320. Special fittings or

welded assemblies fabricated in shop or field shall conform to this code. The material of special welding fittings shall conform to ASTM Specifications A 216, A 217, or A 234, or to the requirements of part 5230.0320. Special fittings or welded assemblies shall be construed to embrace cast, forged, rolled, or extruded fittings of special dimensions, and built-up manifolds, segmental elbows, fabricated swages, orange-peel bull plugs, or any similar construction not covered by American Standards B16.9 or B16.11 for factory-made welding fittings.

**Statutory Authority:** *MS s 326.46*

#### **5230.0870 PIPE JOINTS.**

For minimum requirements cast-iron flanges shall conform to the 25 psi American Standard B16b2. Companion flanges shall conform to Class 125 American Standard B16.1. Bronze flanges shall conform to 150-pound American Standard B16.24. Unions when used shall be suitable for the pressures. For joints other than welded, refer to part 5230.1050, subpart 2. Screwed joints may be used for pipe sizes as detailed under part 5230.1050, subpart 2. Welded joints shall be constructed as detailed under part 5230.1070 and welding operators shall qualify according to part 5230.1070, subpart 2. Cast-iron pipe joints for this class of service may be welded with bronze, nickel, or nickel alloy, or 18 Cr-8 Ni electrodes, if the temperature is not over 353 degrees Fahrenheit.

**Statutory Authority:** *MS s 326.46*

#### **5230.0880 PIPE.**

Pipe shall be of steel, wrought iron, brass, copper, or cast iron. For limitations on copper pipe and tube and brass pipe, see part 5230.0960, subpart 7.

**Statutory Authority:** *MS s 326.46*

#### **5230.0890 BOLTING.**

Bolting material shall be of steel or wrought iron.

**Statutory Authority:** *MS s 326.46*

#### **5230.0950 BOILER FEED SYSTEMS AND OTHER WATER PIPING NOT OTHERWISE COVERED.**

Subpart 1. **Requirements.** The following requirements shall apply to all boiler feed systems and systems for water, except that on boiler feed systems the piping from the boiler drum or equivalent point to and including the feed valves required by ASME Boiler and Pressure Vessel Code.

Subp. 2. **Highest pressure and temperature.** Hot water systems shall be designed for the highest pressure and temperature actually existing in the piping under normal operation.

Boiler feed piping systems shall be designed for the highest pressure exerted by the boiler feed pumps at any load under normal operation and on the highest corresponding temperature, actually existing. Where water passes through heaters in series, the temperature rating of the piping shall conform to the actual temperatures produced by the heaters in each part of the system; but in no case shall pipe or fitting be rated less than 1.25 times the safety valve setting on the boiler.

**Statutory Authority:** *MS s 326.46*

#### **5230.0960 BOILER FEED PIPING.**

Subpart 1. **Two means of feeding water.** Boilers having more than 500 square feet of water heating surface shall have at least two means of feeding water. Each source shall be capable of supplying water to the boiler at a pressure of six percent higher than the highest setting of any safety valve on the boiler. For boilers that are fired with solid fuel not in suspension, one source of feeding shall be steam operated.

Subp. 2. **Check valve and globe valve or plug cock.** The feed pipe to the boiler or boilers shall be provided with a check valve and at least one globe valve or plug cock. The stop or globe valve to be placed between the check valve and boiler and when a globe valve is used, the water inlet shall be under the disk.

Subp. 3. **Pressure requirement.** All valves and fittings on the feed water piping from the pump to the boiler including the stop and check valves shall be equal at least to the requirement of the American Standards for a pressure 1.25 times the maximum allowable working pressure of the boiler or 1.25 times the lowest set pressure of any safety valve in the boiler drum, except as otherwise provided in the ASME Boiler Code or American Standards Association.

Subp. 4. **Materials.** Valves and fittings made of any material permitted by the code for pressure rating of 125 pounds or more and marked as required by the code may be used for feed line and blowoff service up to 80 percent of the rated pressure, except where certain materials are specified, and in no case shall they be used for temperatures exceeding that permitted by the code.

Subp. 5. **Design.** Where the pressure and temperature requirements of the feed piping system, as defined in part 5230.0950 fall within the scope of part 5230.0610, inclusive, the feed piping system shall be designed in accordance with these paragraphs but flanges, fittings, and valves may be selected in accordance with the adjusted pressure-temperature ratings given in the American Standard for Steel Pipe Flanges and Flange fittings B16.5. Where the requirements of the feed piping system or hot water piping, as defined in part 5230.0950, fall within the scope of parts 5230.0650 to 5230.0690 and parts 5230.0750 to 5230.0790, inclusive, the entire piping system including fittings and flanges shall conform to or at least be equal to the steam piping requirements in parts 5230.0650 to 5230.0690 and parts 5230.0750 to 5230.0790.

All pressures and temperatures specified in parts 5230.0950 and 5230.0960 refer to continued normal operation. For short time operation excess pressures and temperatures may be allowed as specified in part 5230.0520.

Subp. 6. **Bypasses.** No bypasses around valves shall be required for pressures under 600 psi. For pressures 600 psi and above, it is recommended that all valves eight inches and over in size be equipped with a bypass of at least three-fourths inch nominal size.

Subp. 7. **Exceptions.** Brass or copper pipe and tube may be used where a temperature of 406 degrees Fahrenheit is not exceeded.

Cast-iron pipe may be used where a pressure of 300 psi or a temperature of 450 degrees Fahrenheit is not exceeded.

**Statutory Authority:** *MS s 326.46*

### 5230.0970 BLOWOFF PIPING AND TANKS.

Subpart 1. **Classification.** The following requirements for blowoff piping apply to the entire system beyond the blowoff valves on the boiler to the blowoff tank or other point where the pressure is reduced approximately to atmospheric and cannot be increased by closing a valve. However, boiler blowoff piping that may be subjected to full boiler pressure, shall be capable of withstanding full boiler pressure.

Subp. 2. **Design.** Blowoff piping shall be designed as for saturated steam in accordance with the following table, but all fittings shall be of steel.

A. Steel fittings shall be used on the blowoff piping between the boiler and the blowoff valves when the pressure exceeds 100 psi. All pipe connections between the boiler and the blowoff tank shall be made as direct as possible using sweep bends having a radius of four times the diameter of the pipe. Where conditions make the use of sweep bends prohibitive, long sweep fittings that comply with the standards of blowoff fittings set out in the ASME Power Code may be used.

B. The inlet shall enter the shell at a tangent and shall be above the surface of the water in the tank. A wearing plate shall be attached to the inside of the shell opposite the inlet opening.

C. The outlet opening shall be connected with internal pipe or baffle extending downward to within a few inches of the bottom of the tank. A three-fourth inch syphon breaker shall connect the outlet piping with the vent pipe.

# MINNESOTA RULES 2007

1013

## PIPEFITTERS; POWER PIPING SYSTEMS 5230.0990

### Subp. 3. Recommended pipe sizes for blowoff systems up to 450 pounds.

Blowoff Inlet	Water Outlet	Vent
* 3/4	3/4	2
1	1	2-1/2
1-1/4	1-1/4	3
1-1/2	1-1/2	4
2	2	5
2-1/2	2-1/2	6

\*For boilers of 100 square feet of heating surface or less.

A. The blowdown from any boiler shall not be connected directly to any sanitary sewer system. The blowdown must first pass through a blowoff tank or other apparatus that will reduce the pressure to not more than five pounds and the temperature to not more than 180 degrees Fahrenheit.

B. All piping between the boiler and blowoff valve on pressures exceeding 100 pounds shall be of double strength. Galvanized pipe or fittings shall not be used.

C. When the pressure exceeds 100 pounds, two blowoff valves shall be used, at least one valve shall be of the slow opening type.

D. Globe valves or gate valves are not to be used on new installations unless such globe or gate valves are designed for blowoff service.

E. Blowoff tanks shall be installed in such a manner that inspection can be made of any part of the tank at all times.

F. Blowoff tanks placed underground shall be installed in a properly walled pit with a space of not less than 18 inches between the tank and wall, and not less than 12 inches between the tank and the floor.

G. The end of the blowoff pipe from any steam boiler or the vent pipe from any blowoff tank or other apparatus shall not terminate in any location where the discharge can endanger the life or limb of any person or the property in which any such apparatus is located.

H. The state plumbing code provides: "The exhaust, blowoff, sediment, or drip pipe from any steam boiler or steam trap shall not be connected directly to any sewer, drain, soil waste, or vent pipe. The water or steam of condensation from such pipe before it shall enter any sewer or drain shall be discharged into a suitable catch basin or condenser." The foregoing section is adopted and made a part of this code.

**Statutory Authority:** *MS s 326.46*

### 5230.0980 WATER COLUMN.

Crosses shall be used on all right angle turns on the piping to the water column. The minimum size pipe connecting the water column to the boiler shall be not less than one inch in diameter.

No pipe connections may be made on the water column piping except those connected to equipment or appurtenances used to measure, record, or regulate. This would include steam gauge, low water cutoff, pressure controls, pump controls, etc. Not included would be such equipment as whistles or soot blowers.

Cast-iron plugs shall not be used in crosses. Galvanized pipe or galvanized fittings shall not be used on any connection directly to the boiler.

If any valves are used between the water column and boiler, they shall be of the straight way type with either a lever or rising stem and shall be sealed open.

On power boilers where pressures exceed 100 pounds, two valves shall be used on the blowoff pipe on the water column, one of which shall be of the plug type with gland and shall be installed as close to the water column as possible.

**Statutory Authority:** *MS s 326.46*

### 5230.0990 SAFETY VALVES.

Subpart 1. **Required number.** Each boiler shall have at least one safety valve and if it has more than 500 square feet of water heating surface, it shall have two or more safety valves.



Subp. 2. **Two or more valves.** When two or more safety valves are used on a boiler, they may be mounted either separately or as twin valves made by placing individual valves on Y bases, or duplex valves having two valves in the same body casing. Twin valves in the same body shall be the same size.

Subp. 3. **Connection.** The safety valve or valves shall be connected to the boiler independent of any other steam connection, and attached as close as possible to the boiler, without any unnecessary intervening pipe or fitting. Every safety valve shall be connected so as to stand in an upright position, with spindle vertical.

Subp. 4. **Placement.** No valve of any description shall be placed between the required safety valve or valves and the boiler, nor on the discharge pipe between the safety valve and the atmosphere. When a discharge pipe is used, the cross-sectional area shall be not less than the full area of the outlet. All safety valve discharges shall be so located or piped as to be carried clear from running boards or platforms. If the discharge pipe is more than ten feet in length, the diameter of the pipe should be increased to the next size to relieve any back pressure on the safety valve. If the discharge pipe runs in both a horizontal and vertical position, it shall be pitched away from the valve and properly drained.

Subp. 5. **Vertical position.** When a safety valve discharge pipe runs in a vertical position it should be supported with proper hangers in such a manner as to avoid any vibration or undue stress on the safety valve, and also provisions must be made to drain any collection of condensate so it will not accumulate above the seat of the safety valves. It is recommended that drip pan elbows be used whenever possible to drain accumulation of condensation from relief valves.

**Statutory Authority:** *MS s 326.46*

#### 5230.1000 STEAM PIPING.

When boilers are connected to a common steam main, the steam connection from each boiler having a manhole opening shall be fitted with two stop valves having an ample free blow drain between them. The discharge of this drain shall be visible to the operator while manipulating the valve. The stop valves shall consist preferably of one automatic nonreturn valve set next to boiler and a second valve of the outside-screw-and-yoke type; or, two valves of the outside-screw-and-yoke type shall be used.

When pressure reducing valves are used, one or more relief or safety valves shall be provided on the low pressure side of the reducing station in the event that the piping or equipment on the low pressure side does not meet the requirements for the full initial pressure. Proper protection shall be provided to prevent possible injury or damage caused by the discharge from the safety valves. The relief or safety valves shall be installed as close to the reducing valves as possible. It is mandatory that a pressure gage be installed on the low pressure side of the reducing valve.

**Statutory Authority:** *MS s 326.46*

#### 5230.1010 SERVICE WATER AND CONDENSING WATER SYSTEMS.

Subpart 1. **Above 175 psi but not above 400 psi.** Service water piping systems above 175 psi but not above 400 psi shall be designed as prescribed for 250 psi saturated steam pressure in parts 5230.0650 to 5230.0690, except that for valves, the manufacturer's rating shall be adhered to for the service pressure.

Subp. 2. **Above 43 psi but not above 175 psi.** Service water piping systems above 43 psi but not above 175 psi shall be designed as prescribed for 125 psi saturated steam pressure in parts 5230.0750 to 5230.0790.

Subp. 3. **43 psi and below.** Condensing water and service water systems up to and including 43 psi pressure shall be designed as prescribed for 25 psi saturated steam pressure in parts 5230.0850 to 5230.0890. Bell and spigot joints may be used if permitted by part 5230.1050.

Subp. 4. **Bypasses.** No bypasses around valves shall be required.

Subp. 5. **Welding.** Welding operators for work on service water and condensing water systems shall qualify according to part 5230.1070.

**Statutory Authority:** *MS s 326.46*

**5230.1020 INSTRUMENT AND CONTROL PIPING.**

Subpart 1. **Scope.** These requirements shall apply to the design of instrument and control piping for safe and proper operation of the piping itself. They do not cover design of piping to secure proper functioning of instruments for which the piping is installed.

The term "instrument piping" shall apply to all valves, fittings, tubing, and piping used to connect instruments to main piping or to other instruments or apparatus or to measuring equipment as used within the classification of part 5230.0260.

The term "control piping" shall apply to all valves, fittings, tubing, and piping used to interconnect air or hydraulically operated control apparatus also classified in accordance with part 5230.0260 as well as to interconnect instrument transmitters and receivers.

"Sampling piping" shall apply to all valves, fittings, tubing, and piping used for the collection of samples of steam, water, and oil. It shall conform to minimum requirements for the main line to which it connects.

This paragraph does not include tubing used in permanently closed systems, such as fluid-filled temperature responsive devices.

Subp. 2. **Materials and design.** The materials employed for valves, fittings, tubing, and piping shall meet the particular conditions of service and the requirements of the applicable specifications listed under general parts 5230.0320 to 5230.0350, with allowable stresses.

Subp. 3. **Takeoff connections.** Takeoff connections at the source together with attaching bosses or adapters when used shall be made of material at least equivalent to that of the pipe or vessel to which they are attached. They shall be designed to withstand full line pressure and temperature and all stresses including those induced by fatigue, without failure. The nominal pipe size of the takeoff connections shall be not less than one-half inch for service conditions not in excess of either 900 psi or 800 degrees Fahrenheit, and three-fourths inch nominal pipe size (for adequate physical strength) for conditions which exceed either of these limits.

To prevent overstressing the main stream line by contact with the colder condensate return from the instrument, steam meter, or instrument takeoff connections shall be lagged in with the steam main. For temperatures in excess of 800 degrees Fahrenheit they may also be arranged to make metallic contact lengthwise with the steam main.

Bosses or adapters may be used for temperatures not exceeding 800 degrees Fahrenheit, provided the hole drilled through the pipe wall is the same diameter as the inside diameter of the takeoff connections. For higher temperatures the adapter may be provided with a thermal sleeve which extends entirely through the pipe wall.

Subp. 4. **Main line shutoff valves.** Shutoff valves shall be provided at the end of takeoff connections. They shall be capable of withstanding the maximum working pressure and temperature of the piping system to which the takeoff nipples are attached.

Subp. 5. **Reservoirs or condensers.** In dead end steam service, and optionally for other services, condensing reservoirs, and connecting nipples which immediately follow the main line shutoff valves, shall be made of low carbon steel or other suitable material for the saturated steam temperature corresponding to the actual line pressure.

Subp. 6. **Connecting tubing or piping.** For instruments between shutoff valves and instrument:

A. Copper, copper alloys, and other nonferrous materials, may be used in dead end steam, water, oil, and similar services up to the maximum main line pressures and temperatures provided that the temperature within the connecting lines for continuous service does not exceed 406 degrees Fahrenheit. Where condensers are used of a design such that they are filled with part steam and part water so that the temperature of the water in the reservoir is above 406 degrees Fahrenheit, a five-foot length of uninsulated steel tubing shall immediately follow the condenser, ahead of the connecting copper tubing to the instrument.

B. For higher pressures and temperatures steel or alloy steel may be used up to the maximum.

C. The minimum size of the tubing or piping is a function of its length, the volume of fluid required to produce full scale deflection of the instrument, and the service of the in-

strument. When required to prevent plugging as well as to obtain sufficient mechanical strength, the inside diameter of the pipe or tube should not be less than 0.36 inch, with a wall thickness of not less than 0.049 inch. When these requirements do not apply, smaller sizes with wall thickness in due proportion, may be used.

D. The piping shall be designed in accordance with part 5230.0510, with due allowance for water hammer when required. Unless required by corrosive conditions however, the factor "C" need not apply. In view of the absence of proper standards on the matter, the hardness of the tubing used should conform to the specifications established by the manufacturer of the fittings to be used.

For control: the same materials may be used for control piping as for instrument piping except that the minimum inside diameter shall be 0.178 inch instead of 0.36 inch, with a minimum wall thickness of 0.028 inch.

Subp. 7. **Other valves.** Blowdown valves at or near the instrument shall be of the gradual opening type and for steam service shall be suitable for saturated steam temperature corresponding to the actual line pressure. For other than steam service they shall be suitable for the actual main line pressure and temperature.

When blowdown valves are used, valves at the instrument as well as any intervening fittings and tubing between such blowdown valves and the meter, may be suitable only for 1-1/2 times the design pressure at 100 degrees Fahrenheit. When blowdown valves are not used, instrument valves shall conform to the requirements of the first paragraph of this subpart.

Subp. 8. **Fittings and joints.** For dead-end steam service and for water above 100 degrees Fahrenheit, steel fittings of the flared or socket welded types, part 5230.1130, subpart 2, items A and C, or other suitable types of similar design shall be used in accordance with the pressure-temperature conditions given in the chart in this section.

Subp. 9. **Special safety provisions.** Connecting piping subject to clogging from solids or deposits shall be provided with suitable connections for cleaning. Connecting piping handling air and gases containing moisture or other extraneous materials shall be provided with suitable drains or settling chambers or traps in accordance with part 5230.0470. Connecting piping to which may contain liquids shall be protected from damage due to freezing by heating or other adequate means.

Subp. 10. **Supports.** Supports shall be furnished as specified in part 5230.0450 not only for safety but also to protect the piping against detrimental sagging, external mechanical injury, abuse, and exposure to unusual service conditions.

Subp. 11. **Installation.** Instrument and control piping shall be inspected and tested in accordance with parts 5230.0480 and 5230.0500, and cleaned as specified in part 5230.0490.

**Statutory Authority:** *MS s 326.46*

### 5230.1030 FABRICATION OF PIPE HANGERS, SUPPORTS, ANCHORS, SWAY BRACINGS, AND VIBRATION DAMPENERS.

Subpart 1. **General materials requirements.** All materials used in the fabrication of equipment included in this chapter of the code shall be capable of meeting the general requirements designated herein. The dimensions and the physical and chemical characteristics of these materials shall be chosen so that the factors of safety, under the operating conditions, are not less than those specified herein under part 5230.1040, subpart 8. Construction equal to or better than required by this code is mandatory, including the use of materials having physical and chemical properties at least equal to its minimum requirements.

Subp. 2. **Materials standards.** The policy of the sectional committee in making reference to standards and specifications is stated in part 5230.1120, subpart 4. All materials used shall be capable of meeting the respective standard specifications given in part 5230.0320.

Subp. 3. **Specific material requirements.** All equipment for permanent hangers, supports, and anchors shall be fabricated from durable materials for the service conditions involved.

In tunnels and in buildings of fireproof construction, the use of wood and wire for piping supports shall be limited to rigging and temporary supports during erection. All permanent supports shall be fabricated from noncombustible materials.

# MINNESOTA RULES 2007

1017

## PIPEFITTERS; POWER PIPING SYSTEMS 5230.1040

In buildings of nonfireproof construction and in areas outside of buildings, piping may be supported by or hung from wooden structures provided that all piping used for conveying fluids at a temperature above 230 degrees Fahrenheit shall be spaced for insulated from such wooden members to prevent dangerous heating.

Steel or wrought iron, except as provided in subpart 3 and part 5230.1040, subparts 2 to 4, shall be used throughout in the fabrication of hanger rods, turnbuckles, beam clamps, pipe clamps, and straps, chains, supports, rollers, guides, bases, and all other parts used for the support of piping. Parts of supports which are subjected principally to bending or tension loads, and which are subjected to working temperatures for which carbon steel is not recommended, shall be made of suitable alloy steel.

**Statutory Authority:** *MS s 326.46*

### 5230.1040 SPACING BETWEEN PIPE SUPPORTS.

Subpart 1. **Maximum spacing.** Suggested maximum spacing between pipe supports for straight runs of standard wall pipe and heavier pipe at maximum operating temperature of 750 degrees Fahrenheit.

(Does not apply where there are concentrated loads between supports, such as flanges, valves, specialties, etc.)

Nominal Pipe Size Inches	Maximum Span Feet
1	7
1-1/2	9
2	10
2-1/2	11
3	12
3-1/2	13
4	14
5	16
6	17
8	19
10	22
12	23
14	25
16	27
18	28
20	30
24	32

The above spacing based on a combined bending and shear stress of 1500 psi when pipe is filled with water and the pitch of the line is such that a sag of 0.1 inch between supports is permissible.

Subp. 2. **Cast iron.** Cast iron may be used for the fabrication of roller bearing bases, rollers, guides, anchor bases, brackets, and parts of piping supports upon which the loading will be mainly that of compression. Cast iron shall not be used for hanger rods, turnbuckles, clamps, or any parts which will be subjected principally to tension loads.

Subp. 3. **Malleable iron castings.** Malleable iron castings of suitable design may be used for pipe clamps, beam clamps, hanger flanges, clips, bases, swivel rings, and parts of pipe supports but their use shall be limited to such cases where the malleable iron will not be within a distance of 12 inches from piping subjected to temperatures of 450 degrees Fahrenheit.

Subp. 4. **Corrosion resistant metals.** Nonferrous metals or corrosion-resisting steel alloys should be used for equipment to support piping under conditions causing excessive corrosion of ordinary steel or wrought iron. Cast iron or malleable iron castings, if warranted as a protection against the expected corrosion, also may be used but their use shall be subject to the requirements of subparts 2 and 3.

**Subp. 5. Protective coatings.** Under conditions causing atmospheric rusting or slight corrosion, corrosion-resisting materials need not be used, but a protective coating such as a hot dipped galvanizing, a weather-resisting paint, or other suitable protection shall be applied after fabrication to all parts where required. Under conditions causing mild corrosion such as atmospheric rusting, which are not of an intensity to warrant the use of corrosion-resistant materials, a durable protective coating such as hot-dipped galvanizing, weather-resisting paint or other suitable protection should be applied to all parts after fabrication or after installation.

Under any conditions, exposed screw threads on parts of this equipment where corrosion-resisting materials are not used shall be greased immediately after fabrication. Paints, slushes, or other suitable protective coatings may be used instead of grease.

**Subp. 6. General limitations.** The following limitations apply:

A. Supports shall prevent excessive variation of supporting effort, and possible resonance with imposed vibrations. The construction shall also be such that complete release of the piping load will be impossible in the case of spring failure or misalignment.

B. The fabrication of helical and elliptical springs for spring hangers and supports shall be in accordance with the respective specifications. Springs shall be fabricated so that the proper working fiber stress, depending upon the type of spring and the service for which it is intended, shall not be exceeded.

C. All parts of the supporting equipment shall be fabricated and assembled so that they will not be disengaged by movement of the supported piping.

D. Pipe, straps, or bars of strength equal to the equivalent hanger rod may be fabricated for use instead of hanger rods.

E. Hangers used for the support of piping of two inch minimal pipe size and larger shall be fabricated to permit adequate adjustment after erection while still supporting the load. Exception to this maybe made in cases where hangers are to be used for the support of piping requiring exact grades, for which they may be fabricated as rigid hangers.

F. Screw adjustments shall be fabricated so that all threaded members conform to American Standard B1.1 coarse-thread series Class 2 fit. Turnbuckles and adjusting nuts shall have the full length of thread in service. Means shall be provided for determining that full length of thread is in service. All screw or equivalent adjustments shall be provided with suitable locking features.

G. Supports shall be spaced so as to prevent excessive sag, bending, and shear stresses in the piping, with special consideration given to those piping sections where flanges, valves, etc., impose concentrated loads. Where calculations are not made, suggested maximum spacing of hangers or supports for carbon steel piping operating at 750 degrees Fahrenheit and lower are given in this part. Where greater distance between supports, concentrated loads, higher temperatures, or vibration considerations are involved, special consideration should be given to effects of bending and shear stresses. See also part 5230.1060, subpart 5, item E.

**Subp. 7. Dimensional limitations.** The following dimensional limitations apply:

A. Straps. Straps shall be limited to the minimum dimensions of one-eighth inch thickness by one inch width for use in locations protected from the weather. The minimum strap thickness for locations exposed to the weather shall be one-fourth inch. As exceptions to this, where straps are to be used for supporting pipe of one inch nominal size or smaller, the minimum strap dimensions shall be 1/16 inch thickness by three-fourths inch width in locations protected from the weather, and one-eighth inch thickness in locations exposed to the weather.

B. Hanger rods. The maximum load carried by a hanger rod used for the support of piping shall be based on the allowable stress of the material as specified in Par. 607, except that in no case shall hanger rods less than three-eighths inch diameter be used for supporting pipe of two inch nominal size and smaller or less than one-half inch diameter rod for supporting pipe 2-1/2 inches nominal size and larger. Safe loads for all threaded hanger rods shall be based on the root area of the threads. When the temperature of any part of a hanger rod does not exceed 450 degrees Fahrenheit and hanger rod material conforms to ASTM Specifica-

# MINNESOTA RULES 2007

1019

## PIPEFITTERS; POWER PIPING SYSTEMS 5230.1040

tion A 107, such rods may be used for support of loads not in excess of those given in this part. Where rods are exposed to the weather or other corrosive elements, they shall be protected as stated in subpart 5 or fabricated from materials as described in subpart 3, according to the conditions. The minimum rod sizes for ferrous materials for these corrosive conditions shall be given for the noncorrosive condition. For nonferrous materials the minimum rod area for corrosive conditions shall be increased by the ratio of allowable stresses of steel to allowable stress of the nonferrous material used.

C. Load carrying capacities of threaded, hot, rolled, steel rod to ASTM Spec. A-107.

Nominal Rod Diameter	Root Area Thread	Maximum Safe Load, Pounds, 450 degrees Fahrenheit
3/8	0.068	610
1/2	0.126	1,130
5/8	0.202	1,810
3/4	0.302	2,710
7/8	0.419	3,370
1	0.552	4,960
1-1/8	0.693	6,230
1-1/4	0.889	8,000
1-3/8	1.053	9,470
1-1/2	1.293	11,630

D. Chain. Chain used for hangers shall be limited to stock having a minimum diameter of 3/16 inch or equivalent area for supporting pipe of two inches nominal size or smaller. For supporting pipe of 2-1/2 inches nominal size and larger, chain used in the fabrication of hangers which are to be located in places protected from the weather shall be limited to stock having a minimum diameter of three-eighths inch or equivalent area. Rods for chain hangers shall be fabricated in accordance with subpart 7. Where such composite chain hangers are to be exposed to the weather or other corrosive elements, castings, and chain stock as well as the rods and all parts shall be fabricated, where applicable, from materials with the same minimum requirements as described in subpart 4 or protected as stated in subpart 5 according to conditions. The minimum sizes of chain stock for these corrosive conditions shall be as given above for the noncorrosive condition.

E. Bolted clamps. Bolted clamps formed from plate or rectangular sections used in connection with rod or chain hangers shall have minimum thickness of 3/16 inch. Bolts used with these clamps shall have a minimum diameter of three-eighths inch. All parts of the bolted clamps, including bolts, shall conform with the requirements of part 5230.1030, subpart 3; and subpart 9 of this part.

F. Welded attachments. Lugs, plates, angle clips, etc., used as part of an assembly for the support or guiding of pipe may be welded directly to the pipe provided the material is of good weldable quality and the design is adequate for the load. The design of hanger lugs for attachment to piping for high temperature service shall be such as to provide for differential expansion between the pipe wall and the attached lug. Welds shall be proportioned so that the shear stresses shall not exceed 0.8 times the S values of the code under which piping is designed for the respective operating temperatures of the piping. If materials for attachments have different stress values than the pipe the lower stress value of the two should be used. All such attachment welds shall be preheated as required for the pipe. Postheating is required for carbon steel attachments to carbon steel pipe if the attachment welds exceed three-fourths inch throat dimension. Preheating and postheating of attachments to alloy pipe shall be in accordance with the procedure qualifications. Welding shall be done by operators and procedures qualified in accordance with the rules of part 5230.1070.

Subp. 8. **Allowable stresses.** The allowable stress for the base material of all parts of supporting assemblies shall not exceed the appropriate S value taken from the allowable stress tables in the applicable section of the code at the maximum operating temperature of the part in question for seamless material of the same nominal chemical analysis and with tensile and yield strengths not higher than the materials used.

For other carbon steel materials used below 650 degrees Fahrenheit the allowable stress shall be no more than 12,000 psi.

The allowable stress shall be reduced 25 percent for threaded members based on the area, at the root of threads and for welds in support assemblies or for attachments to piping.

An increase in allowable stress of 20 percent shall be allowed for short time overloading conditions.

For requirements pertaining to springs see subpart 6, items A and B.

**Subp. 9. Loading.** The required strength of all supporting equipment, except springs, shall be based on the weight of the pipe, the weight of medium transported, or the medium used for testing, whichever is heavier, and the weight of the insulating cover, if used.

Weight calculations for springs should be based upon the normal operating conditions of the piping. They should not include the weight of the hydrostatic test fluid. Springs shall be designed for unit fiber stresses that will not be exceeded during any condition of loading or test; otherwise suitable travel stops to prevent overstressing the spring shall be provided.

Exceptions may be made in the case of supporting equipment for large gas or air piping, exhaust steam relief, or safety valve relief piping, but only under conditions where the possibility of any of these lines becoming full of water or other liquid is very remote.

Wind pressure shall be included in the calculations for the strength and structural features of the supports for exterior piping. Snow and ice loads shall also be considered in localities where such conditions occur.

**Subp. 10. Supports permitting pipe movement.** Hangers and supporting equipment shall be fabricated and assembled to permit the free movement of piping as caused by thermal expansion and contraction or by other causes. This should be accomplished by the use of long rod hangers, spring hangers, chains, hangers, or supports fitted with rollers, machined blocks, elliptical, or circular rings of larger diameter than the pipe causing contact only at the bottom, trolley hangers, or equivalent. Rolling supports shall be accurately made, properly guided, and shall roll freely. Hanger rods shall be provided with welded or forged eyes, pivoting clamps, T heads with suitable sockets, or equivalent. In all cases allowance shall be made for rod clearance to permit swinging without setting up severe bending action in the rods. When pipe is covered by insulation, a suitable metal shield properly constructed and secured to the covered pipe should be used to protect the covering at points where the pipe is supported on movable rolling supports or in larger diameter rings, except that where the nature of the material permits, the pipe may rest directly on the insulation without metallic supports.

**Subp. 11. Spring hangers, compensating hangers, sway bracings, and vibration dampeners.** The following limitations apply:

A. The design fabrication and installation of this equipment shall not constrain the piping when expansion or contraction occurs, to such an extent as to cause excessive transfer of loads from support to piping or from support to support. In any case, supports, whether of the rigid or spring types, shall be capable of taking the entire piping load imposed by weight transfer, by failure of springs in spring supports, or added load resulting from testing during erection.

B. All springs shall be provided with means to prevent misalignment, buckling, eccentric loading of the spring, and with stops to prevent excessive spring deflection that would be the cause of excessive spring stresses.

C. It is recommended that all hangers employing springs be provided with means to indicate at all times the proper position of the spring with respect to the hot and cold position of the piping system, except where they are used either to cushion against shock or where the operating temperature of the piping system does not exceed 250 degrees Fahrenheit.

D. Each spring or compensating-type hanger or support shall be designed to exert a supporting force equal to the load at point of attachment to the pipe, as determined by weight balance calculations. On high temperature and critical lines where changes in thermal conditions in the piping cause a change in supporting effect of such hanger or support, the excess or deficiency of support shall be included in the determination of total stresses in the piping.

E. On high temperature and critical piping at locations subject to appreciable movement with thermal changes, the use of spring or compensating type hangers or supports,

designed to provide a substantially uniform supporting force equal to the load throughout the range of travel, is recommended. The piping should also be supported in a manner to keep thrust and moments on equipment at a minimum.

F. On high temperature and critical piping when conditions of item E do not apply, either compensated type hangers or supports, or spring hangers, which are designed for a maximum variation in supporting effect of 25 percent for the total vertical travel between the hot and cold positions, may be used.

G. When necessary to prevent abnormal movement or vibration in pipelines, sway braces or vibration dampeners shall be used. They shall be installed so as to cause minimum possible restraint to the normal thermal movements. The use of sway braces of the energy-absorbing or instant counter force acting type are recommended for control of undesirable pipeline movement. Rigid braces are also effective in controlling movement provided they do not restrict the flexibility of the piping or provided their effect is taken into account in the design of the piping flexibility.

Subp. 12. **Counterweights.** Counterweights when used instead of spring hangers shall be provided with stops to limit travel. Weights shall be positively secured with bolts or placed in suitable box compartments. The fabrication of chains, cables, hanger, and rocker arm details, or other devices used to apply the counterweight load to the piping, shall be subject to the requirements indicated herein under part 5230.1030, subparts 1 and 2.

Subp. 13. **Anchors and guides.** Anchors, guides, pivots, or restraints shall be fabricated and assembled in such a form as to secure the desired points of piping in relatively fixed positions. They shall permit the line to expand and contract freely in opposite directions away from the anchored or guided point, and shall be so arranged as to be structurally suitable to withstand the thrust, torsional forces, and load conditions of operation. Materials and fabrication shall be in accordance with the requirements of parts 5230.1030, subparts 1 and 3, and 5230.1040, subpart 8.

Where corrugated or slip-style expansion joints are used, anchors shall be provided to force the expansion movement into the joint, with such anchors designed to withstand a force equal to the force as recorded by the manufacturer for the operating pressure at which the joint is to be used. If the manufacturer does not supply this force figure, the anchor shall be designed to withstand a force equal to the sum of the product of the maximum internal area times the maximum working pressure in the line plus an allowance to overcome friction. Where friction factor is not known, the anchor shall be designed to withstand a force equal to twice the product of the maximum internal area times the maximum pressure in the line. In all cases the allowable stresses in the line shall be in accordance with part 5230.1040, subpart 8.

All lines containing expansion joints shall be properly guided to direct movement into the expansion joint.

**Statutory Authority:** *MS s 326.46*

### **5230.1050 FABRICATION OF PIPE JOINTS OTHER THAN WELDED.**

Subpart 1. **Classification.** The following classifications apply:

A. Ferrous pipe. Specific requirements are outlined herein for threaded joints and the more common type of flanged joints. However, this code permits the use of special joints such as rubber or flexible rings held tight by pressure and properly retained; sleeve or gland type, hub and spigot, screwed, or flanged union connections, flared and compression type joints, and any other connection, the joints and materials of which are suitable for the service conditions encountered as required by other sections of the code.

B. Nonferrous pipe. Valves, fittings, and flanges may be attached to nonferrous pipe and tubing by the following methods, and may be used at pressures and temperatures permitted by this code for the pipe or tubing unless otherwise specified: by threading when the pipe is made to standard pipe size dimensions, by flanged or lapped connection, by flared or compression type joints where such joints are suitable for the pressure encountered, or by soldered or brazed socket sleeve type joints.

Joints of the socket sleeve type, in accordance with American Standard for Cast Brass Solder-Joint Fittings, ASA B16.18, and American Standard for Wrought Copper and Wrought Bronze Solder-Joint Fittings, ASA B16.22, may be used for pressure and temperature ratings therein specified.



Other socket sleeve type joints using a brazing solder melting at or above 1,100 degrees Fahrenheit, where the brazed junction between pipe and sleeve extend full depth of socket, are acceptable. Fillet brazed joints are not acceptable.

Subp. 2. **Threaded joints.** Screw threads shall conform to American Standard for Tap-Per Pipe Threads, ASA B2.1, or to API Standards 5L for line pipe threads and 5A for casing threads.

Subp. 3. **Flange requirements.** The following requirements apply:

A. Flanges cast or forged integral with pipe, fittings, or valves shall be permitted in sizes and for the maximum service ratings covered by the American Standards or as defined in other sections of this code.

B. Screwed companion flanges shall be permitted in sizes and for maximum service ratings covered by American Standards or as defined in other sections of this code. The requirements for threaded joints in part 5230.1050, subpart 3 apply to this type of flange.

C. Lapped flanges shall be permitted in sizes and pressure standards established in the American Standard for Steel Pipe Flanges and Flanged Fittings, ASA B16.5, or as defined in other sections of this code.

D. Slip-on welding flanges shall be permitted in sizes and pressure standards established in the American Standard for Steel Pipe Flanges and Flanged Fittings, ASA B16.5, or as defined in other sections of this code. For methods of welding, see part 5230.1230, figure 6a-b. For service below 150 psig, slip-on flanges fabricated from flat plates may be substituted for hubbed slip-on flanges, provided the inherent weakness of locating the weld at the region of highest flange stress is taken into account in establishing the service temperature and pressure conditions. For service 150 psig and above, slip-on flanges fabricated from flat plate may be used provided the thickness of the flange is equivalent to the flange thickness of the next higher pressure class for the same size (ASA B16.5). The method of attachment shall be as shown in part 5230.1050, subpart 3, figure 6 a-b.

E. Welding neck flanges shall be permitted in sizes and pressure standards established in the American Standard for Steel Pipe Flanges and Flanged Fittings, ASA B16.5, or as defined in other sections of this code. The bore of the flange shall correspond to the inside diameter of the pipe used. The welding shall comply with part 5230.1070 on welding of pipe joints.

F. Socket-welding flanges shall be permitted in sizes and pressure established in the American Standard for Steel Pipe Flanges and Flanged Fittings, ASA B16.5, or as defined in other sections of this code.

G. Steel flanges, provided with grooves into which the pipe is expanded, shall be permitted in sizes and for maximum service ratings outlined for screwed companion flanges in part 5230.1050, subpart 3.

Subp. 4. **Flange facing, facing finish, and flange bolting.** The following limitations apply:

A. The flanges described in the following standard are regularly faced as shown below:

Rating	Material	Dimensional Standard	Facing
25	Cast iron	ASA B16b2	Plain (flat)
125	Cast iron	ASA B16.1	Plain (flat)
250	Cast iron	ASA B16b	1/16 raised
150 & 300	Brass or bronze	ASA B16.24	Plain (flat)
150	Corrosion resistant	MSS SP-42	Plain (flat)
150 & 300	Steel	ASA B16.5	1/16 raised
400, 600, 900, 1,500 & 2,500	Steel	ASA B16.5	1/4 raised

B. Other flange facings as shown in American Standard for Steel Pipe Flanges and Flanged Fittings, ASA B16.5, are permitted. Such facings shall be subject to pressure temperature limitations shown in ASA B16.5 or as defined in other sections of this code.

C. The finish of facings shall be in accordance with MSS Standard Finishes for Contact Faces of Connecting-End Flanges of Valves and Fittings, MSS SP-6.

D. Twenty-five psi and class 125 cast-iron integral or screwed companion flanges may be used with a full face gasket or with a ring gasket extending to the inner edge of the bolt holes. When using a full-face gasket, the bolting may be of heat-treated carbon steel, ASTM A 261, or alloy steel, ASTM A 193. When using a ring gasket, the bolting shall be of carbon steel equivalent to ASTM A 307 Grade B without heat-treatment other than stress relief.

E. When bolting together two class 250 integral or screwed companion cast-iron flanges, having 1/16 inch raised faces, the bolting shall be of carbon steel equivalent to ASTM A 307 grade B, without heat-treatment other than stress relief.

F. 150 psi steel flanges may be bolted to cast-iron valves, fittings, or other parts, having either integral class 125 cast-iron flanges or screwed class 125 companion flanges. When such construction is used, the 1/16 inch raised face on the steel flange shall be removed. When bolting such flanges together using a ring gasket extending to the inner edge of the bolt holes, the bolting shall be of carbon steel equivalent to ASTM A 307 grade B, without heat treatment other than stress relief. When bolting such flanges together using a full face gasket, the bolting may be heat treated carbon steel, ASTM A 261, or alloy steel, ASTM A 193.

G. 300 psi steel flanges may be bolted to cast-iron valves, fittings, or other parts having either integral class 250 cast-iron flanges or screwed class 250 cast-iron flanges or screwed 250 cast-iron companion flanges without any change in the raised faces on either flange. Where such construction is used, the bolting shall be of carbon steel equivalent to ASTM A 307 grade B, without heat treatment other than stress relief. Good practice indicates that the raised face on the steel flange should be removed, but also in this case, bolting shall be of carbon steel equivalent to ASTM A 307 grade B without heat-treatment other than stress relief.

Subp. 5. **Gaskets.** The following limitations apply:

A. Dimensions of nonmetallic gaskets are shown in American Standard for Non-metallic Gaskets, ASA B16.21.

B. Paper, vegetable fiber, rubber, or rubber-inserted gaskets shall not be used for temperatures in excess of 250 degrees Fahrenheit.

C. Asbestos composition gaskets may be used as permitted in the American Standard for Steel Pipe Flanges and Flanged Fittings, ASA B16.5. This type of gasket shall not be used on lines carrying oil or other fluids above their spontaneous ignition temperatures unless specifically approved in the individual sections of this code.

D. The use of metal or metal asbestos gaskets, is not limited as to pressure provided that the gasket material is suitable for the service temperature. These types of gaskets are recommended for use with the small male-and-female or the small tongue-and-groove facings. They may also be used with steel flanges having large male-and-female, large tongue-and-groove, or raised face.

E. Full face gaskets shall be used with all bronze flanges and are recommended for corrosion resistant steel flanges conforming to MSS SP-42, and may be used with 25 psi or class 125 cast iron flanges. Ring gaskets, with an outside diameter extending to the inside of the bolt holes, may be used with cast iron flanges or with plain or raised face steel flanges.

F. In order to secure higher unit compression on the gasket, gaskets of a width less than the full male face of the flange may be used with steel flanges with any of the following facings; raised face, large male and female; otherwise, widths of gaskets for large male and female joints are recommended to be equal to the width of the male face. Widths of gaskets for small male and female, or for all tongue-and-groove joints shall be equal to the width of the male face, or tongue. All gaskets shall have an inside diameter equal to, or larger than, the port opening.

G. Rings for ring joints shall be of dimensions and quality established in the American Standard for Ring-Joint Gaskets and Grooves for Steel Pipe Flanges and Flanged Fittings, ASA B16.20.

**Statutory Authority:** *MS s 326.46*

**5230.1060 EXPANSION AND FLEXIBILITY.**

Subpart 1. **Scope.** The provisions of this chapter are not applicable to gas, air, and oil cross-country transmission (underground) piping.

Subp. 2. **Preamble.** Piping systems are subject to a diversity of loadings creating stresses of different types and patterns, of which only the following more significant ones need generally be considered in piping stress analysis: pressure, internal or external; weight of pipe, fittings, and valves, containing fluid and insulation, and other external loadings such as wind; or thermal expansion of the line.

The first two loadings produce sustained stresses which are evaluated by conventional methods. The stresses due to thermal expansion on the other hand, if of sufficient initial magnitude will be relaxed as a result of local flow in the form of yielding or in the form of creep. The stress reduction which has taken place will appear as a stress of reversed sign in the cold condition. This phenomenon is designated as self-springing of the line and is similar in effect to cold springing. This amount of such self-springing will depend on the magnitude of the initial hot stress and the temperature. Accordingly, while the hot stress tends to diminish with time, the sum of the hot and cold stresses during any one cycle will remain substantially constant. This sum is referred to as the stress range. The fact that the stress range is the determining factor leads to the selection of an allowable combined stress (range) in terms of the sum of the hot and cold S values.

Subp. 3. **Adverse conditions.** Where due to severe service conditions or special configurations, excessive local strains may occur under prolonged heating in materials of limited ductility, the effect of such conditions should be considered. For example, it is possible to have a pipe line configuration with the following adverse conditions:

A. one or more branches which are small in size compared with the majority of the piping;

B. a calculated high expansion stress level in the small size branch with the remainder of the piping at relatively low expansion stress levels; or

C. a relatively small elastic deformation in the small size branch coincident with the high expansion stress level; and a relatively large amount of absorbed expansion stored in the low stressed areas of the system to act as an elastic follow up spring thereby maintaining elastic deformation on the small size, high expansion stressed area.

When all three of the above conditions exist, it is possible to produce an undesirable amount of creep in the small size, high expansion stressed area. Such undesirable creep could be avoided by a redesign of the piping or by judicious cold springing of the system. Until more is known about the fabrication and treatment of austenitic steels, it is recommended that the design of piping systems of such materials be approached with greater overall care as to general elimination of local stress raisers, inspection, material selection, fabrication quality, and erection. As a part of this approach the need for hot plastic flow can be minimized by careful cold springing.

Subp. 4. **Cold springing.** The beneficial effect of judicious cold springing in assisting the system to attain its most favorable condition sooner is recognized. Inasmuch as the life of a system under cyclic condition depends primarily on the stress range rather than the stress level at any one time, no credit for cold spring is warranted with regard to stresses. In calculating end thrusts and moments acting on equipment containing moving or removable parts with close clearances, the actual reactions at any one time rather than their range are significant and credit accordingly is allowed for cold spring in the calculations of thrusts and moments.

Subp. 5. **Materials.** The following limitations apply:

A. This chapter applies to all classes of materials permitted by the code.

B. The thermal expansion range shall be determined from item C the difference between the unit expansion shown for the maximum normal-operating metal temperature and that for the minimum normal-operating metal temperature. For hot lines, this may usually be taken as the erection temperature. For materials not included in this table, reference shall be made to authoritative source data, such as publication of the National Bureau of Standards.

# MINNESOTA RULES 2007

1025

PIPEFITTERS; POWER PIPING SYSTEMS 5230.1070

## C. Linear expansion of piping:

Constants per 100 feet

Formula:

Metal

E = expansion in inches per 100 feet of pipe

Steel .00804

Wrought Iron .00816

F = starting temperature

Cast Iron .00780

T = final temperature

Copper and Brass .01140

E = constant x (T - F)

D. General: Piping systems shall be designed to have sufficient flexibility to prevent thermal expansion from causing failure from over-stress of the piping material or anchors, leakage at joints, or detrimental distortion of connected equipment resulting from excessive thrusts and moments.

Flexibility shall be provided by changes of direction in the piping through the use of bends, loops, and offsets; or provisions shall be made to absorb thermal strains by expansion joints of the slip joint or bellows type.

If desirable, flexibility may be provided by creasing or corrugating portions or all of the pipe.

In this case, anchors or ties of sufficient strength and rigidity shall be installed to provide for end forces due to fluid pressure and other causes.

In order to modify the effect of expansion and contraction, runs of pipe may be cold sprung. Cold spring may be taken into account in the calculation of the reactions as shown, provided an effective method of obtaining the designed cold spring is specified and used.

To find temperature of saturated steam, take square root of gauge pressure times 14 plus 198.

Example: Find temperature of 100# psi saturated steam.

$$100^2 = 10 \times 14 = 140 \text{ plus } 198 = 338 \text{ degrees Fahrenheit.}$$

$$100\# \text{ Saturated Steam} = 338 \text{ degrees Fahrenheit.}$$

E. Supports: Pipe supports and restraints not expressly considered in flexibility calculations shall be designed to minimize interference with the thermal expansion of the line. The design and spacing of supports shall be checked to assure that the sum of the longitudinal stresses due to weight, pressure, and other sustained external loading does not exceed allowable stress.

F. Elastic constants and coefficients of thermal expansion. The coefficients of thermal expansion and values of linear expansion per 100 feet are given in item C.

**Statutory Authority:** *MS s 326.46*

## 5230.1070 WELDING OF PIPE JOINTS.

Subpart 1. **Scope.** This part concerns the welding of pipe joints in both wrought and cast ferrous materials, and more specifically covers butt joints in pipe, valves, flanges and fittings, and fillet joints in pipe branches, slip-on flanges, socket weld fittings, etc., as applied in pipe lines and connections to apparatus or equipment. The requirements of this code are applicable except where the welding of such joints are covered by other codes or state regulatory bodies, such as the Power Boiler and Unfired Pressure Vessel sections of the ASME Boiler and Pressure Vessel Code. The general provisions of this part are subject to accompanying code regulations as to pressure, temperature, and fluid carried.

This part applies to the manual application of shielded metal arc, inert gas metal arc, and gas welding processes, and to the automatic, semiautomatic, and machine welding application of the submerged arc and inert gas shielded arc processes. These rules may, however, be applied to other manual or machine welding processes in so far as the rules are applicable.

Standard qualifications for welding procedures, welders, and welding operators made in accordance with section IX of the ASME Boiler and Pressure Vessel Code will also qualify for such work under this code as outlined below.

Subp. 2. **Manufacturer's or contractor's responsibility.** Each manufacturer or contractor shall be responsible for the quality of the welding done by the organization and shall, except as provided in item F, conduct tests not only of the welding procedure to determine its suitability to insure welds which will meet the required tests, but also of the welders to determine their ability to properly apply the procedure, as follows:

A. The welding procedure followed during the qualifying test shall be recorded in detail, and shall be accessible to the purchaser or the purchaser's agent. This procedure shall be adhered to during subsequent construction. Recommended forms for recording the results of procedure qualification tests are given in part 5230.1110, subparts 1 and 2.

B. Qualification tests on ferrous materials shall be in accordance with the provisions of parts 5230.1090 and 5230.1100. Qualification tests may be in accordance with the provisions of part A, section IX, ASME Boiler and Pressure Vessel Code.

C. Welding qualification tests on nonferrous materials shall be in accordance with part B, Requirements for Nonferrous Materials, section IX, ASME Boiler and Pressure Vessel Code.

D. The employer shall assign an identification number, letter, or symbol to each welder which shall be used to identify the work of that welder.

E. The employer shall maintain a record of the welders employed, showing the date and result of tests and the identification mark assigned to each. These records shall be certified by the manufacturer and be accessible to the purchaser or the purchaser's agent.

F. To avoid duplication of qualification tests of procedures or welders, the procedures or welders qualified as required above by one employer may, if suitable, be accepted by another employer on piping using the same or an equivalent procedure wherein the essential variables are within the limits established in parts 5230.1090, subpart 2, and 5230.1100, subpart 4. It is the contractors, fabricators, or purchasers prerogative to accept or reject qualification tests made by others. An employer accepting the qualification tests of welders by another employer shall clearly indicate in the record of such welders, the employer by whom the welders were qualified and the dates of such qualification; by so doing the employer accepts the responsibility for the welder's work.

Subp. 3. **Definitions.** For convenience in reference, some of the more common terms relating to pipe welding are defined in "Standard Welding Terms and Their Definitions," American Welding Society A3.0.

Subp. 4. **Material.** All ferrous materials used in the fabrication of any welded pipe or piping assembly or attachments welded thereto, and covered by this code shall be of good weldable quality and conform to ASTM or API material specifications.

Subp. 5. **Base metal preparation for welding.** Butt welds: preparation of pipe ends shall be done preferably by machining and/or grinding, although oxygen or arc cutting is acceptable if the cut is reasonably smooth and true and all heavy oxide is thoroughly cleaned from the flame cut surfaces. Preheating may be required on certain alloy materials of the air hardening type in order to prevent surface checking or cracking adjacent to the torch-cut surface. The discoloration which may remain on the flame cut surface is not considered to be detrimental oxidation. End preparations are given in part 5230.1200, figure 3, as representing present recommended practice. For more detailed dimensional information, reference may be made to American Standard Steel Pipe Flanges and Flanged Fitting, ASA B16.5.

Surfaces for welding shall be cleaned and shall be free from paint, oil, rust, scale, or other objectionable material which may be detrimental to the weld.

The ends of pipe-to-pipe, pipe-to-fitting, and pipe-to-valve joints shall be aligned as accurately as is practical within the existing commercial tolerances on pipe diameters, pipe wall thickness, and out-of-roundness. Alignment should provide the most favorable conditions for the deposition of the root bead. This alignment must be preserved during welding. In smaller internal diameter shall be internally trimmed so that the adjoining internal diameters will result in approximately the same thickness as in part 5230.1210, figure 4. In no case, however, shall trimming of the inside diameter result in a wall thickness less than the minimum required for the service condition as prescribed in the applicable section of this code.

The root opening of the joint shall be as given in the manufacturer's procedure specification.

Backing rings may or may not be used. Where ferrous metal backing rings are used they shall be made from material of good weldable quality and shall not exceed .05 percent sulfur. The material of the backing ring should be compatible with the chemical composition of the pipe, valve, fitting, or flange with which it is to be used and preferably be of the same composition. When two abutting surfaces are welded to a third member used as a backing ring and one or two of the three members are ferritic and the other member or members are of an austenitic grade of material, a procedure qualification shall be required. Backing rings may be of the continuous machined or split band type. Some acceptable types are shown in part 5230.1220, figure 5.

If pipe ends are bored for accurate fitting machined rings, such boring shall not reduce the pipe wall below the minimum required thickness. In some instances it may be necessary to deposit weld metal on the inside diameter of the pipe or welding fitting to provide sufficient material for machining to insure satisfactory seating of machined backing rings.

If the pipe ends are of the upset type they may be bored to allow for a completely recessed backing ring, provided in any case the remaining net section of the finished joint is not less than the minimum required thickness.

Backing rings of nonferrous or nonmetallic materials may be permitted provided they have no effect on the mechanical, physical, and chemical properties of the weld. The satisfactory use of such materials shall be determined by procedure qualification.

Fillet welds: slip-on flanges, socket weld fittings, and valves shall be prepared in accordance with applicable parts of this subpart and reference to parts 5230.1230, figure 6, and 5230.1240, figure 7.

A one-eighth inch vent hole may be desirable in the hub of any slip-on flange which is subject to being front and back welded and which is also subject to furnace stress relieving.

**Subp. 6. Welding procedure.** Butt welds: butt joints may be of the single vee, double vee, or other suitable type of groove with or without backing rings. When backing rings are used, typical joint designs as in subpart 5 are recommended. When backing rings are used and the nominal pipe wall thickness and service conditions are such that it is not considered necessary or practical to machine the inside of the pipe, the joint design shown in part 5230.1220, figure 5 is recommended. When backing rings are used and the nominal pipe wall thickness and service conditions are such that it is considered necessary to machine the inside of the pipe, the joint designs shown in part 5230.1220, figure 5 (b) or (c) or applicable combinations of these joint design details are recommended.

If tack welds are used, they shall either be made by a qualified welder and the same procedure as the completed weld, or be removed during the welding operation. When heavy assemblies are transferred from the location of fit-up to the location of welding, extreme care should be exercised to see that all joints have been adequately tack welded or welded to prevent the cracking of these welds, or the distortion of the assembly during such transfer. Piping which is to be welded in place shall be properly aligned and adequately supported during tack welding and subsequent welding in order to avoid the possible cracking of tack welds and initial beads.

The welding procedure shall be such as to assure substantially full root penetration and thorough fusion of the deposited metal with the base metal. Assurance of the specified degree of penetration actually obtained in production welds, is dependent upon the degree and type of examination made. The degree of examination and basis of rejection shall be a matter of prior agreement between the fabricator or contractor and purchaser.

The external surface of butt welds shall be free from undercuts greater than 1/32 inch in depth, overlaps or abrupt ridges or valleys and shall merge smoothly into the pipe surface at the weld toe. The thickness of weld reinforcement shall not exceed 3/32 inch for pipe thickness up through one-half inch, one-eighth inch for pipe thickness over one-half inch through one inch, or one-eighth inch times weld width for pipe thickness over one inch.

Fillet welds may be convex to concave. The size of a fillet weld is determined by the leg length of the largest inscribed right isosceles triangle.

Seal welding of threaded joints is permitted provided the external threads are entirely covered by the seal weld. Seal welds shall not exceed three-eighths inch throat dimension

and shall not be considered as contributing to the strength of joints. Seal welding shall be done by qualified welders.

Subp. 7. **Preheating.** Preheating shall be required as stipulated for the various materials listed in the various "P" groups, as follows:

A. Preheating of materials listed under "P" numbers 1 and 2 is not mandatory but under certain conditions is recommended. Under field conditions or otherwise where the ambient temperature is less than 32 degrees Fahrenheit, local preheating to a hand-hot condition is suggested for all materials listed in "P" numbers 1 and 2. Experience has indicated that preheating to 250 degrees Fahrenheit is advisable (regardless of ambient temperature) when welding those materials listed under "P" number 1 which have minimum tensile properties of 70,000 psi or higher.

B. Preheating to 300 degrees Fahrenheit minimum shall be required when welding all materials listed under "P" number 3.

C. Preheating to 375 degrees Fahrenheit minimum shall be required when welding all materials listed under "P" number 4.

D. Preheating to a temperature of 450 degrees Fahrenheit minimum shall be required when welding material listed under "P" numbers 5 and 6.

E. Preheating of material listed under "P" number 7 shall be a matter of agreement between the manufacturer or contractor and the purchaser.

F. Preheating of the austenitic stainless grades of material listed under "P" number 8 is optional and is not a requirement of this code.

G. When welding dissimilar materials having different preheat requirements, the preheating temperature shall be that established in the procedure specification.

Preheating may be accomplished by any suitable method provided that it is uniform and that the temperature is maintained above the minimum during the actual welding operations.

The preheating temperature shall be checked by the use of temperature indicating crayons, thermocouple pyrometers, or any other suitable method to assure that the required preheat temperature is obtained prior to and maintained during the welding operation.

Subp. 8. **Stress relieving schedule.** Unless otherwise provided in other sections of this code, the following stress relieving schedule will apply:

A. Welded joints in carbon steel materials as listed under "P" number 1, shall be stress relieved when the pipe wall thickness is three-fourths inch or greater. In unreinforced and reinforced branch connections, the thickness of the run shall govern. When flanges are attached by fillet welds, the thickness of the pipe shall govern.

B. Welded joints in wrought iron pipe as listed under "P" number 2 shall require stress relieving only as a matter of agreement between the purchaser and the fabricator.

C. Welded joints in carbon molybdenum steel material listed under "P" number 3, shall be stress relieved when the pipe wall thickness is one-half inch or greater.

D. Welded joints in all other alloy materials listed under "P" number 3, and all materials listed under "P" numbers 4, 5, and 6, shall be stress relieved without regard to wall thickness.

E. Stress relieving or other post weld heat treatment of the high alloy ferritic materials listed under "P" number 7 and the austenitic stainless grades of material listed under "P" number 8 is not a requirement of this code, but may be performed as a matter of agreement between the purchaser and the fabricator. If stress relieving or heat treatment is agreed upon, it should be compatible with the analysis of both the base metal and the weld metal and should be determined as most suitable for the particular service application.

F. In welds between dissimilar ferritic materials, if either material requires stress relieving, the joint shall require stress relieving.

G. In welds between austenitic and ferritic materials, stress relieving or other post weld heat treatment of the welded joint is optional. Stress relieving or heat treatment, if used, shall be a matter of agreement between the contractor and the purchaser. Due to differences in the coefficient of thermal expansion existing between dissimilar materials, careful consideration should be given to the selection of a heat treatment, if any, that will be beneficial to the welded joint.

Subp. 9. **Stress relieving temperature.** Stress relieving should not be confused with other post weld heat treatments which, if required, shall be a matter of agreement between the manufacturer and the purchaser. Such post weld heat treatments may or may not obviate the necessity of stress relieving depending upon the maximum temperature attained in the post weld heat treatment and the rate of cooling from the temperature.

Stress relieving shall be performed at a temperature of 1,100 degrees Fahrenheit or over for carbon steels, and 1,200 degrees Fahrenheit or over for ferritic alloy steels. The exact temperature range shall be established in the procedure specification.

When stress relieving a joint between dissimilar ferritic materials or between austenitic and ferritic materials, having different stress relieving requirements, the temperature used shall be that established in the procedure specification.

The parts heated shall be brought uniformly to the required temperature and held at that temperature for a period of time proportioned on the basis of at least one hour per inch of pipe wall thickness, but in no case less than one-half hour, and shall be allowed to cool slowly and uniformly.

Subp. 10. **Methods of stress relieving.** Methods of stress relieving are:

A. Heating the complete structure as a unit.

B. Heating a complete section containing the weld or welds to be stress relieved before attachment to other sections of work.

C. Heating a part of the work by heating slowly a circumferential band containing the weld at the center. The width of the band which is heated to the required temperature shall be twice that of the weld reinforcement but need not exceed the width of the weld reinforcement by more than two inches. Extreme care should be used to obtain a uniform temperature around the entire circumference of the pipe. The temperature shall diminish gradually outward from the ends of this band.

D. Branches or other welded attachments for which stress relief is required, should preferably be furnace stress relieved. Where furnace stress relief is impractical, local stress relief may be accomplished by heating a circumferential band around the pipe on which the branch or attachment is welded with the branch or attachment at the middle of the heated band. The width of the band shall be at least two inches greater than the diameter of the weld joining the branch or attachment to the header. The entire band shall be brought up to the temperature and held for the time specified.

Subp. 11. **Equipment for local stress relieving.** Stress relieving may be accomplished by electric induction heating, electric resistance heating, fuel fired ring-burners, fuel fired torch, or other suitable means of heating provided a uniform temperature is obtained and maintained during the stress relieving cycle.

Subp. 12. **Checking temperature.** The stress relieving temperature shall be checked by the use of thermocouple pyrometers or other suitable equipment to be assured that the proper stress relieving cycle has been accomplished.

Subp. 13. **Identification.** After completing a welded joint, the welder shall stamp or otherwise identify it as the welder's work with his or her assigned number, letter, or symbol.

Subp. 14. **Hydrostatic tests.** Piping and associated equipment fabricated with welded joints shall be capable of withstanding hydrostatic tests as specified in the section of this code covering the class of service for which the pipe is to be used.

In all cases, the required test pressure shall be maintained a sufficient length of time to enable an inspection to be made of all joints and connections.

Subp. 15. **Inspection of welded joints.** Inspection of welded joints:

A. The acceptability of all types of production welds, whether or not complete or random radiography, magnetic particle, fluid penetrant, sectioning, etc., are specified, shall also be judged on the basis of a careful visual examination and/or shop or field hydrostatic test. Injurious defects shall be removed and repaired in accordance with items C and D.

B. When required in the specification or contract, or by agreement between the purchaser and the manufacturer or contractor, the quality of butt welds shall be checked, as follows:



When random radiographic examination, sectioning, or a combination of both, are specified, welded butt joints shall conform to ASME Unfired Pressure Vessel Code, section VIII, par. UW-52, except that unfusion attendant to root misalignment as permitted in subpart 5 shall be considered acceptable provided that such does not encroach on the minimum wall thickness. Furthermore, penetration shall be complete to the inside diameter of the pipe which has the greater inside diameter of the two pieces being joined.

When full radiographic examination is specified, welded butt joints shall conform to the ASME Unfired Pressure Vessel Code, section VIII, par. UW-51.

C. All defects in welds requiring repair, shall be removed by flame or arc gouging, grinding, chipping, and/or machining. All repair welds shall be made using the same, or other qualified welding procedures as that used in making the original welds, including preheating and stress relieving if originally required.

D. All repair welds shall meet the requirements of subpart 2 and shall be acceptable to the purchaser or the purchaser's agent.

Subp. 16. **Qualification of procedures and welders.** The qualification of welding procedures, welders, and welding operators for welded joints of pipe shall be in accordance with parts 5230.1090 and 5230.1100. Qualification tests may also be made in accordance with the provisions of part A, section IX, ASME Boiler and Pressure Vessel Code.

**Statutory Authority:** *MS s 326.46*

**History:** *17 SR 1279*

### 5230.1080 STANDARD QUALIFICATION FOR WELDING PROCEDURES, WELDERS, AND WELDING OPERATORS.

Subpart 1. **General requirements.** Specific reference to the following material is made in part 5230.1070. Reference to this chapter in general, and to part 5230.1070, subpart 2 in particular, should be made before proceeding further in Appendix A of the ANSI code. It is assumed that the manufacturer or contractor has an organization familiar with the various welding codes and capable of designing, engineering, and supervising welded construction.

Each manufacturer or contractor is responsible for the welding done by the organization, and shall conduct the tests required in this section to qualify the welding procedures being used in the construction of the weldments built under this code and the performance of welders and welding operators as defined in part 5230.1100 who apply these procedures, and shall maintain records thereof.

Subp. 2. **Scope.** The following rules apply to the qualification of welding procedures and welder performance for all types of manual, semiautomatic and automatic arc and gas welding processes permitted in other sections of the code. These rules may also be applied in so far as they are applicable to other manual or machine welding processes.

Subp. 3. **Definitions.** Some of the more common terms relating to welding are defined in the American National Standard Code for Pressure Piping, Power Piping, published by ASME, 1983 edition, as amended. These are in substantial agreement with the definitions of the American Welding Society, A 3.0 given in "Standard Welding Terms and their Definitions".

Subp. 4. **Weld orientation.** The orientations of pipe welds with respect to horizontal and vertical planes of reference are classified in accordance with part 5230.1250, figure 8 into four positions. These are flat, horizontal, vertical, and overhead.

Subp. 5. **Welding positions for qualification tests.** Welding positions for qualification tests:

A. Test welds for both procedure qualification and performance qualification shall be made on groove welds in pipe in one or more of the specified basic qualification test positions shown in part 5230.1260, figure 9. An angular tolerance of  $\pm 15$  degrees from the specified horizontal and vertical planes shall be allowed in making the test welds.

B. Both procedure and performance qualifications on groove welds in pipe in a given position, shall also qualify for groove welds in plate and fillet welds in pipe and plate for equivalent welding positions as shown in part 5230.1260, figure 9.

C. The basic qualification test positions are, as follows:

(1) pipe, horizontal rolled; weld, flat position. Pipe with its axis in the horizontal plane and rolled during welding so that the weld metal is deposited from the top and within  $\pm 15$  degrees from the vertical plane;

(2) pipe, vertical fixed; weld, horizontal position. Pipe with its axis in the vertical position and the weld with its axis in the horizontal plane;

(3) pipe, horizontal fixed; weld, flat, vertical, and overhead positions. Pipe with its axis in the horizontal plane and the welding groove in the vertical plane. Welding shall be done without rotating the pipe so that weld metal is deposited from the flat, vertical, and overhead positions.

D. Qualification in test position covered in item C, subitem (1) qualifies for that position only. Test positions covered in item C, subitem (2) or (3) shall qualify for the respective test positions and also for test position covered in item C, subitem (1).

Qualification in test position covered in both item C, subitems (2) and (3) are required for qualification in all weld positions, regardless of orientation of weld or pipe axis.

E. In cases when production welding is to be done in one particular position outside of that defined in item C, subitem (1) both procedure and welder qualification may be made for that position, with the limitation that procedure and welder qualification shall be varied only for the actual special position tested. An angular tolerance of  $\pm 10$  degrees shall apply.

**Subp. 6. Types of test specimens.** Test specimens for making qualification tests are two types; reduced-section tension specimens and guided-bend specimens. The reduced-section tension test is used to determine the tensile strength of the weld joint in procedure qualification tests. The dimensions and preparation of the test specimen shall conform to the requirements. The alternative 0.505 in. specimen may be used for material three-fourths inch and over in thickness. The guided-bend test is used to check for degree of soundness and ductility of the weld in both procedure and performance qualification tests. Guided-bend test specimens are of three kinds, as follows:

A. Side-bend test specimens that conform to the requirements shall be used in making guided-bend tests of welds that are over three-fourths inch in thickness and may be used in making guided-bend tests of welds that are over three-eighths inch in thickness.

B. Face-bend and root-bend test specimens that conform to the requirements shall be used in making guided-bend tests of welds that are 1/16 inch to three-eighths inch in thickness and may be used in making guided-bend tests of welds that are up to three-fourths inch in thickness. The face bend specimen shall be bent with the face of the weld in tension, and the root bend specimen shall be bent with the root of the weld in tension.

**Subp. 7. Reduced section tension tests.** The reduced-section tension test specimens shall be ruptured under tensile load. The tensile strength shall be computed by dividing the maximum load by the product of the least width and corresponding thickness of the specimen as measured before load is applied.

The reduced-section tension test specimen shall have a tensile strength that is not less than the minimum of the specified tensile strength of the base material or of the weaker of the two if materials of different specified minimum tensile strengths are used. If the specimen breaks in the base metal outside of the weld or fusion line, the test shall be accepted as meeting the requirements provided the strength is not more than five percent below the specified minimum tensile strength of the base metal.

**Subp. 8. Guided-bend test.** Side-bend, face-bend, and root-bend specimens shall be bent in a test-jig that has been approved by the Division of Pipefitting Standards. The specimen shall be placed on the die of the test-jig with the weld at mid-span. The side of the specimen turned toward the gap of the jig shall be the face for face-bend specimens, the root for root-bend specimens, and the side with the greater defects, if any, for side-bend specimens. The specimen shall be forced into the die by applying load on the plunger until the curvature of the specimen is such that a 1/32 inch diameter wire cannot be inserted between the die and the specimen.

Guided-bend specimens shall have no cracks or other open defects exceeding one-eighth inch measured in any direction on the convex surface of specimen after bending ex-

cept that cracks occurring on the corners of the specimen during testing shall not be considered, unless there is definite evidence that they result from slag inclusions or other internal defects.

**Statutory Authority:** *MS s 326.46*

**History:** *14 SR 1877; 17 SR 1279*

### 5230.1090 PROCEDURE QUALIFICATION.

**Subpart 1. General requirements.** The procedure of welding to be followed in construction shall be established and recorded in detail by the manufacturer or contractor as a procedure specification, and in the investigation to qualify this procedure, the procedure specification shall be followed. The results of the procedure qualification test shall likewise be recorded in detail. Recommended forms for the procedure specification and procedure qualification test results are given in part 5230.1110, subparts 1 and 2. It is not necessary that these exact forms be used, but the information contained therein should be set forth in any alternate form which is adopted.

**Subp. 2. Essential variables.** The welding procedure must be set up as a new procedure specification and must be completely requalified when any of the changes listed below are made in the procedure. Changes other than those given below may be made in a procedure without the necessity for requalification provided the procedure specification is revised to show these changes.

A. V-1 A change from one welding process to another welding process.

B. V-2 A change in the specification of either or both of the base metals to be welded from one P-number in Table 1 to another P-number. Joints involving two base metals of different P-numbers shall be qualified even where procedure qualification tests on each of the two base metals welded to itself have previously been made.

C. V-3 A change in filler metal analysis or type shall require requalification under the following conditions:

(1) a-1 for metal arc-welding with covered electrodes a change from one F-number to any other F-number;

(2) a-2 for metal arc welding with covered electrodes a change in the chemical composition of the weld deposit from one A-number to any other A-number;

(3) b-1 for gas welding a change from a GAXX to a GBXX type of filler metal and vice versa;

(4) b-2 for gas welding a change from silicon-killed to an aluminum-killed type of filler metal and vice versa;

(5) b-3 for gas welding a change in weld metal composition from one A-number to any other A-number;

(6) c-1 for inert-gas consumable electrode metal arc-welding a change in weld metal composition from one A-number to any other A-number;

(7) c-2 for inert-gas nonconsumable electrode metal arc welding a change in weld metal composition from one A-number to any other A-number;

(8) d-1 for submerged arc welding a change from a filler metal containing 1.75 to 2.25 percent manganese to a filler metal containing less than 1.00 percent manganese or vice versa shall require requalification (the presence or absence of one-half percent molybdenum in the filler metal analysis shall not require requalification);

(9) d-2 for submerged arc-welding a change in filler metal analysis from one A-number to any other A-number;

(10) e-1 for any other welding process a change in the composition of the deposited weld metal from one A-number to any other A-number;

(11) V-4 in submerged arc welding, a change in the nominal composition or type of flux used (requalification is not required for a change in flux particle size);

(12) V-5 the addition of other welding positions than those already qualified (see part 5230.1080, subpart 5);

(13) V-6 a change in the heat treating temperature and time cycle range. The time may vary with the thickness of a specific material without requiring requalification.

(14) V-7 in metal arc-welding, the omission of the backing ring in welding single-welded butt joints; and in gas-welding, the addition of the backing ring in welding single-welded butt joints;

(15) V-8 in semiautomatic or automatic welding, a change from multiple pass per side to single pass per side;

(16) V-9 in semiautomatic or automatic welding, a change from single arc to multiple arc, or vice versa;

(17) V-10 in inert-gas arc-welding (consumable and nonconsumable electrode) a change from one type of inert-gas to another;

(18) V-11 for inert-gas arc-welding, a change from the consumable to nonconsumable electrode process or vice versa;

(19) V-12 For inert-gas nonconsumable electrode arc-welding a change in electrode (such as carbon electrode to tungsten electrode).

**Subp. 3. Preparation of test joint.** The base material, the filler metal, and the joint welding procedure shall comply with the procedure specification. The base materials shall consist of pipe having a minimum nominal diameter of five inches and a minimum wall thickness of three-eighths inch. Larger diameter and heavier wall pipe may be used, however, and will equally satisfy the procedure requirements. A smaller size pipe may be used such as job-size pipe, but in such cases the procedure shall be qualified only within the limitations. The test joint shall be welded using the type of welding groove specified in the procedure specification for use in construction.

**Subp. 4. Type and number of test specimens.** The type and number of test specimens that must be tested to qualify a procedure specification are given in part 5230.1270, subpart 1, figure 10, together with range of thickness that is qualified for use in construction by a given pipe wall thickness used in making the qualification. The test specimens shall be removed in the order shown in part 5230.1270, subparts 1 and 2. All tests shall meet the requirements prescribed in part 5230.1080, subparts 7 and 8.

**Statutory Authority:** *MS s 326.46*

## **5230.1100 PERFORMANCE QUALIFICATION.**

**Subpart 1. Purpose.** These performance qualification tests are devised to determine the ability of welders and operators to make sound welds.

**Subp. 2. Performance qualification of operators.** The following tests are required for operators of machine welding equipment in which the rate of travel and the position of the welding-head with respect to the work are controlled mechanically except for minor adjustments for such factors as out-of-roundness, and lead-angle.

To assure that such an operator can carry out the provisions of the welding procedure, one 12-inch pipe joint, or equivalent length of welded joint shall be examined by radiography for each procedure under which the operator does welding. The radiographs of the joint shall meet the standard for radiography given in the ASME Power Boiler Code, par. P-102 (h) (8) to allow the operator to weld.

Examination by sectioning may be made in lieu of radiographic examination. The welded joint shall be quartered and one side of each of the four cuts shall be etched. Each etched section shall conform to the requirements of par. UW 52 (e) (4) of the 1952 ASME Unfired Pressure Vessel Code.

If objectionable defects are disclosed by the above methods of examination, it shall be cause for examination by the same method of the second and subsequent joints welded by the operator under the machine welding procedure, until the operator demonstrates the capability of carrying out the provisions of the procedure.

Each manufacturer or contractor shall maintain a record of the procedures under which welding operators are examined and the results of the examination.

**Subp. 3. Performance qualification of welders.** Each welder who welds on piping constructed under the rules of this code shall pass the tests prescribed herein for performance qualification. Operators of machine welding equipment as defined in subpart 2 are excluded. The essential variables of the qualification and the test results obtained by each welder shall

be recorded as a performance qualification. A recommended form for recording the performance qualification test results is given in part 5230.1110, subparts 1 and 2.

**Subp. 4. Essential variables.** A welder must be requalified whenever one or more of the changes listed below are made in the procedure specification. Changes other than those listed do not require requalification. A welder that prepares welding procedure qualification test welds meeting the requirements of part 5230.1090, subpart 4 is thereby qualified.

A. W-1 A change from the filler metal used in a performance qualification to a filler metal having a different F-number. Qualification under any F-number up to and including F4 shall qualify a welder for all lower F-numbers. For example, a welder who qualified with number F4 electrodes is thereby qualified to weld with electrodes listed under numbers F1, F2, and F3. Independent qualifications are required for numbers F5 and F6.

B. W-2 The addition of other welding positions than those already qualified. See part 5230.1080, subparts 4 and 5.

C. W-3 A change from upward to downward or from downward to upward in the progression specified for any pass of a vertical weld, other than a wash pass.

D. W-4 The omission of the backing ring in arc-welding single-welded butt joints.

E. W-5 The addition of the backing ring in gas welding.

F. W-6 A change from one welding process to any other welding process.

**Subp. 5. Preparation of test joint.** Test joints shall be prepared as follows:

A. The base material, the filler material, and the welding shall comply with the essential variables entered in the procedure specification, except as otherwise specified in item E.

B. The base material shall consist of pipe having a minimum nominal diameter of five inches and a minimum wall thickness of one-fourth inch.

C. The dimensions of the welding groove for the test joint used in making performance qualification tests on single-welded butt joints with backing ring shall be the same as those for any procedure specification qualified by the manufacturer, or contractor.

D. The dimensions of the welding groove for the test joint used in making performance qualification tests on single-welded butt joints without backing ring shall be the same as those for any procedure specification qualified by the manufacturer.

E. Where a welder is to be qualified with electrodes conforming to ASTM A 316 or A 298, and the proper size pipe materials are not readily available, carbon steel pipe may be substituted for the performance test with the following limitations:

(1) Performance qualification with low-alloy steel electrodes (F-numbers 1, 2, 3, and 4) using carbon steel pipe material is permissible, provided the test specimens are preheated, welded, and postheated in accordance with the procedure specification for the type electrode involved, and further provided that the total alloy content of the weld metal deposit does not exceed six percent.

(2) Performance qualification with austenitic electrodes (F-number 5) using carbon steel pipe material is permissible. No preheating or postheating is required.

**Subp. 6. Type and number of test specimens.** The types and number of specimens required for a performance qualification are given in part 5230.1270, subpart 1, figure 10, together with the range of thickness that is qualified for use in construction by a given wall thickness of test pipe used in making the qualification. All specimens shall be tested and shall meet the requirements prescribed in part 5230.1080, subpart 8.

Two specimens shall be removed from test welds as shown in part 5230.1270, subparts 1 and 2, figures 10 and 11 at approximately 90 degrees apart, with the pipe in the horizontal rolled and vertical fixed position. See part 5230.1260, figure 9. Four specimens shall be removed from the 45 degrees positions of the test weld made with the pipe in the horizontal fixed position. See parts 5230.1260 and 5230.1270. All four specimens shall be tested in order to qualify the welder. Face-bend tests shall be made when required on the specimens from the first and third quadrants part 5230.1270, subpart 1, figure 10. Root-bend tests shall be made, when required, on the specimens from the second and fourth quadrants part 5230.1270, subpart 1, figure 10.

# MINNESOTA RULES 2007

1035

PIPEFITTERS; POWER PIPING SYSTEMS 5230.1110

Subp. 7. **Retests.** A welder who fails to meet the requirements for one or more of the test specimens may be retested. The welder shall make a new test weld for each position on which the welder has failed, all of which shall pass the test requirements.

Subp. 8. **Requalification.** Requalification under a given procedure specification shall be made when there is a specific reason to question the welder's ability to make welds that meet the specification. Requalification need be made in only a single test pipe thickness.

**Statutory Authority:** *MS s 326.46*

**History:** *17 SR 1279*

## 5230.1110 RECOMMENDED FORMS OF PROCEDURE SPECIFICATION.

Subpart. 1. **Metal arc-welding process.**

Procedure Specification for metal arc-welding of \_\_\_\_\_

Specification No \_\_\_\_\_ Date \_\_\_\_\_

Process. The welding shall be done by the metal arc process.

Base metal. The base material shall conform to the specifications for \_\_\_\_\_ (insert here references to standard ASME, ASTM, API, or other code designations, or give the chemical analysis and physical properties).

Filler metal. The filler metal shall conform to Classification Number \_\_\_\_\_ of the ASTM Specification for \_\_\_\_\_ (insert here the title of the desired specification).

Position. The welding shall be done in the \_\_\_\_\_ (give the position or positions in which the welding will be done. See part 5230.1080, subpart 5).

Preparation of base material. The edges or surfaces of the parts to be joined by welding shall be prepared by \_\_\_\_\_ (state whether sheared, machined, ground, gas cut, etc.), as shown on the attached sketches and shall be cleaned of all oil or grease and excessive amounts of scale or rust. (The sketches referred to should show the arrangement of parts to be welded with the spacing and details of the welding groove, if used. Such sketches should be comprehensive and cover the full range of material or base metal thicknesses to be welded.)

Electrical characteristics. The current used shall be \_\_\_\_\_ (state whether direct or alternating and if alternating give the frequency). The base material shall be on the \_\_\_\_\_ (state whether negative or positive when direct current is used) side of the line.

Joint welding procedure. The welding technique, such as electrode sizes, and mean voltages and currents for each electrode, shall be substantially as shown on the attached sketches. (The sketches referred to may be the same as mentioned under "preparation of base material" or may be separate sketches. They should show, for the minimum thickness and for several intermediate thicknesses of base material, the welding technique to be used, whether weaving or beading, the number of layers or passes and diameter of electrode with the mean voltage and current for each layer or pass, and in the case of vertical welds the progression of each pass, whether upward or downward.)

NOTE: Since, in the welding of many materials in the flat position and particularly for the ordinary mild steels, the proper welding "heat" can be readily determined by the appearance of the individual beads of welding, the use of a "standard appearance weld" may be desirable for the flat position. Such a weld should be made in the maximum thickness that will be used in construction, except that the maximum thickness of the standard appearance weld need not exceed three-fourths inch and should show approximately two inches of the surface of each layer, and a cross section through the weld at each layer, where such cross section is found necessary to produce a clearly understandable photograph. When a standard appearance weld is used, the following paragraph should be used in lieu of specifying current and voltage values.

Appearance of welding layers. The welding current and manner of depositing the weld metal shall be such that the layers of welding as deposited shall have the appearance shown on the photographs attached hereto. There shall be practically no undercutting on the side walls of the welding groove or the adjoining base material.

Cleaning. All slag or flux remaining on any bead of welding shall be removed before laying down the next successive bead.

Defects. Any cracks or blow holes that appear on the surface of any bead of welding shall be removed by chipping, grinding, or gouging before depositing the next successive bead of welding.

Peening. (If peening is to be used, it shall be incorporated as part of the specifications, a description being given of the degree of peening to be done.)

Treatment of under side of welding groove. (The method of preparing the under or second side of a groove for welding on that side should be stated in this paragraph.)

Preheating and temperature control. (This paragraph should describe any preheating and control of temperature during and after welding that will be done.)

Heat treatment. (This paragraph should describe any heat treatment or stress relieving that is given the welded parts before or after welding.)

**Subp. 2. Oxyacetylene welding process.**

Procedure specification for Oxyacetylene welding of \_\_\_\_\_

Specification No \_\_\_\_\_ Date \_\_\_\_\_

Process. The welding shall be done by the oxyacetylene process.

Base metal. The base material shall conform to the specifications for \_\_\_\_\_ (insert here references to standard ASME, ASTM, API or other code designations, or give the chemical analysis and physical properties.

Filler metal. The filler metal shall conform to Classification Number \_\_\_\_\_ of the ASTM Specification for \_\_\_\_\_ (insert here the title of the desired specification).

Position. The welding shall be done in the \_\_\_\_\_ (give the position or positions in which the welding will be done. See part 5230.1080, subpart 5).

Preparation of base material. The edges or surfaces of the parts to be joined by welding shall be prepared by (state whether sheared, machined, ground, gas-cut, etc.) as shown on the attached sketches and shall be cleaned of all oil or grease and excessive amounts of scale or rust. (The sketches referred to should show the arrangement of parts to be welded with the spacing and details of the welding groove, if used. Such sketches should be comprehensive and cover the full range of material or base metal thicknesses to be welded.)

Size of welding tip. The range in size of welding tips used shall be as shown on the attached sketch. (The sketches referred to may be the same as mentioned under "preparation of base material" or may be a separate set. They should show the range of tip sizes for each thickness of material).

Nature of flame. The flame used for welding shall be \_\_\_\_\_ (state whether a neutral flame or one with slight excess of acetylene is to be used).

Method of welding. The method of welding shall be that known as \_\_\_\_\_ (describe whether "backhand" or "forehand").

Size of welding rod. The size of rod used for the various base material thicknesses shall be as shown on the attached sketch. (The sketches referred to may be the same as mentioned under "preparation of base material," or may be a separate set.)

Number of layers of welding. The number of layers of welding used shall be as shown on the attached sketches. (The sketches referred to may be the same as mentioned under "preparation of base material" or may be a separate set. They should show the range of thicknesses for which one, two, or more layers are used.)

Cleaning. All slag or flux remaining on any layer of welding shall be removed before laying down the next successive layer.

Defects. Any cracks or blow holes that appear on the surface of any layer of welding shall be removed by chipping, grinding, or gas gouging before depositing the next successive bead of welding.

Peening. (If peening is to be used it shall be incorporated as part of the specifications, a description being given of the degree of peening to be done.)

Treatment of under side of welding groove. (The method of preparing the under or second side of a groove for welding on that side should be stated in this paragraph.)

Preheating and temperature control. (This paragraph should describe any preheating and control of temperature during and after welding that will be done.)

Heat treatment. (This paragraph should describe any heat treatment or stress relieving that is given the welded parts before or after welding.)

**Statutory Authority:** *MS s 326.46*

### 5230.1120 MATERIALS; THEIR SPECIFICATIONS AND IDENTIFICATION.

Subpart 1. **Scope.** This code includes requirements for marking component parts of piping systems which are made in accord with the standards and specifications named in the appendix to this section, and the policy of the sectional committee in making reference to standards and specifications.

Subp. 2. **Marking.** All valves, fittings, flanges, bolting, pipe, and tubing shall be marked in accordance with the marking sections of the standards and specifications to which reference is made in the code, or in accordance with the requirements of MSS SP-25, Standard Marking System for Valves, Fittings, Flanges and Unions of the Manufacturers Standardization Society of the Valve and Fittings Industry.

Subp. 3. **Materials.** All materials used in piping systems designed and constructed under the provisions of this code shall be capable of meeting the physical and chemical properties and tests as set forth in the appropriate specifications given in the individual sections of the code and listed in the appendix to this section. It is strongly recommended that the materials covered by these specifications be used. However, other materials, the specifications for which are not listed but which have properties equal or superior to the minimum requirements herein given, may also be used in accordance with section requirements.

Subp. 4. **Standards and specifications; policy.** Unless otherwise specified, the reference "American Standard" in this code shall mean the latest revision of the standard for the particular purpose as approved by the American Standards Association. The use of the latest revisions of all other standards or specifications mentioned in this code is intended.

The lack of year designation of the numerous dimensional standards and material specifications to which reference is made, and which are, in effect, made a part of the code in so far as they apply, is recognized. It is, however, not considered practicable to refer to a specific edition of each of these standards and specifications in individual sections because they are likely to be revised much more frequently than is this large basic code, and frequent revision of this code just to keep the designation of the reference standard or specification up to date is not considered desirable. Instead, the American National Standard Code for Pressure Piping, Power Piping, published by ASME in New York, the 1983 edition as amended includes specific edition references and will be revised at short intervals as needed.

**Statutory Authority:** *MS s 326.46*

### 5230.1130 FITTINGS FOR INSTRUMENT AND CONTROL PIPING.

Subpart 1. **Scope.** This appendix covers the descriptions of and specification references to the various types of fittings permissible for use with instrument and control piping, covered under part 5230.1020.

Subp. 2. **High-pressure.** High-pressure service:

A. Flared fittings requiring a flaring tool:

(1) The construction of the tube end of flared fittings (i.e., tubing end of connector body, nut, and sleeve when used) shall conform to Specification Mil-F-5509 for minimum performance requirements, except that all straight threads shall be class 2. Modifications may be used if test performance conforms with the requirements of subitem (3).

(2) The angle of flare of tubing shall be 37 degrees from the centerline, or 74 degrees included angle, and flare dimensions shall be in accord with Army-Navy Design 10061.

(3) The test performance shall equal or exceed the requirements of Specification Mil-F-5506.

(4) All pipe threads shall be either American Standard Taper Pipe Threads, ASA B2 or Dryseal American Standard Taper Pipe Threads, NPTF.

B. Flareless fittings. Flareless fittings of which the male connector shall be of a style whereby the gripping member shall grip or bite into the outer surface of the tube, there-



by holding the tube against pressure, without appreciably distorting the inside tube diameter. The gripping member also forms a pressure seal against the body of the fitting.

When the bite-type fitting is used, the joint shall first be made up tight, then disassembled to make sure the depth of "bite" is adequate, and then reassembled.

When the grip-type fitting is used, the outside diameter of the tubing must be determined by "no-go" gage applied to the tube at right angles to each other at the point where the fitting will grip it, to be within the tolerance established by the fitting manufacturer.

The test performance shall equal or exceed the requirements of specification Mil-F-5506.

C. Socket-welded fittings. Socket-welded fittings shall conform in general design to ASA B16.11.

D. Silver-brazed socket-type fittings. Silver-brazed socket-type joints for valves and fittings shall be made with suitable brazing alloys having melting points above 1000 degrees Fahrenheit. Socket depth shall be the equivalent of thread length in fittings of the same diameter and pressure class, and a shoulder shall be provided for the pipe or tubing to butt against. Silver-brazing alloy shall either be end-fed into the fittings, or shall be provided in the form of a preinserted ring in a groove in the fitting. The brazing alloy shall be sufficient to completely fill the annular clearance between the socket and the pipe or tubing.

Subp. 3. **Medium-pressure.** Medium-pressure service:

A. flared type in accordance with SAE General Specifications, Figs. 1 to 4, and Tables 1 and 2, 1949 SAE Handbook;

B. inverted flared type in accordance with SAE General Specifications, Fig. 18, and Tables 11 and 12, 1949 SAE Handbook;

C. compression type, in accordance with SAE General Specifications, Figs. 9 through 13 and Tables 5 and 6 for service up to 500 psi 100 degrees Fahrenheit up to one-half inch tube, 250 psi for larger tubes.

Subp. 4. **Low-pressure.** Low-pressure service:

A. soldered type, per American Standard for Soldered Joint Fittings, ASA B16.18, for service under the following limitations;

B. maximum pressure 50 psi, with max. line temperature well below melting point of solder so as to minimize failure due to creep under load.

**Statutory Authority:** *MS s 326.46*

5230.1200 FIGURE 3: RECOMMENDED END PREPARATIONS.

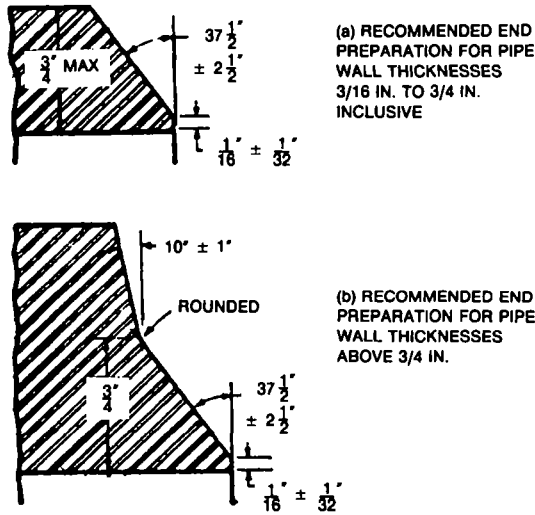

Statutory Authority: *MS s 326.46*

5230.1210 FIGURE 4: BUTT WELDING OF PIPES OR FITTINGS OF UNEQUAL WALL THICKNESSES.

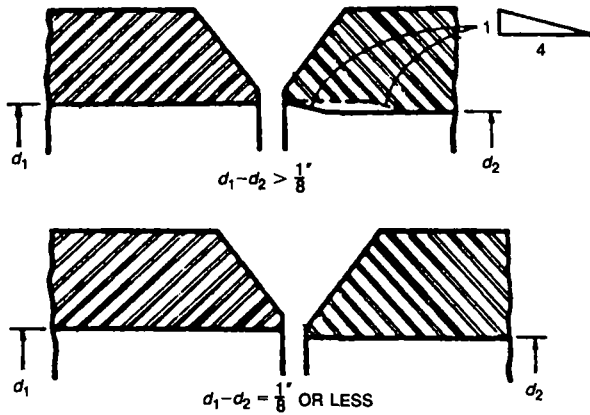

Statutory Authority: *MS s 326.46*

5230.1220 FIGURE 5: TYPICAL JOINTS WITH BACKING RING.

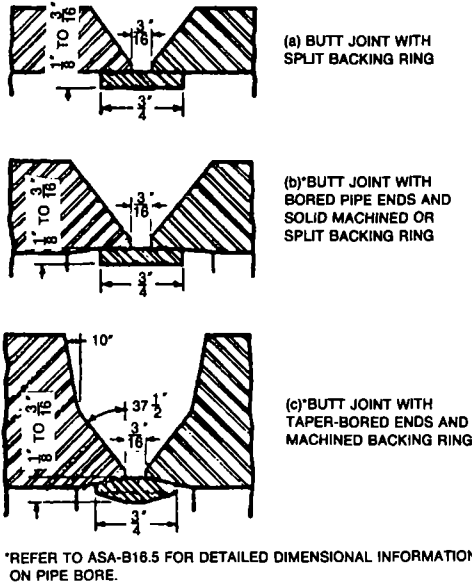

Statutory Authority: *MS s 326.46*

5230.1230 FIGURE 6: DETAILS OF WELDING FLANGES.

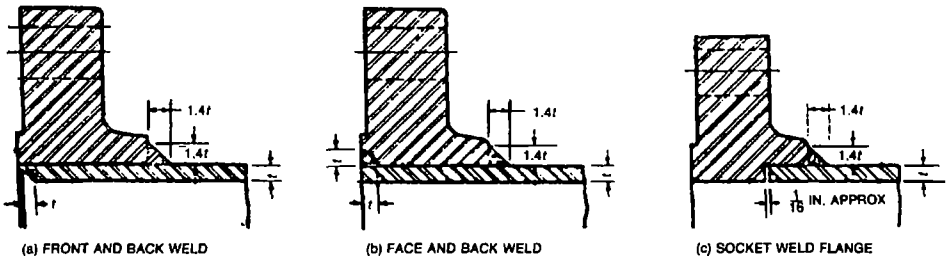

Statutory Authority: *MS s 326.46*

5230.1240 FIGURE 7: MINIMUM DIMENSIONS REQUIRED FOR SOCKET WELD FITTINGS.

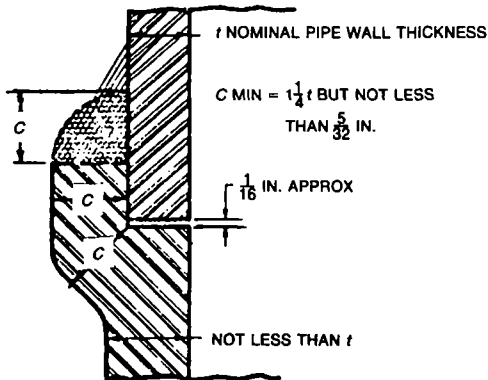

Statutory Authority: *MS s 326.46*

# MINNESOTA RULES 2007

1041

PIPEFITTERS; POWER PIPING SYSTEMS 5230.1250

## 5230.1250 FIGURE 8: POSITIONS OF GROOVE WELDS.

BUTT WELDS IN PIPE IN WHICH THE AXIS OF THE PIPE AT THE JOINT DOES NOT DEVIATE FROM THE HORIZONTAL BY MORE THAN  $\pm 30^\circ$  AND THE PIPE IS ROTATED SO THAT THE WELDING IS ALWAYS DONE WITHIN  $\pm 15^\circ$  OF A VERTICAL PLANE AT THE JOINT.

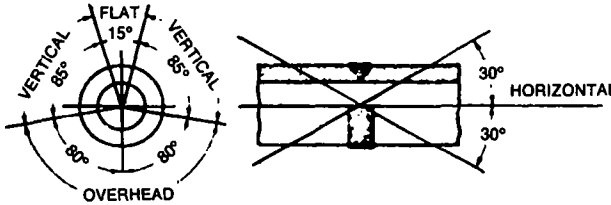

(Horizontal Rolled Position-Flat Weld)

BUTT WELDS IN PIPE IN WHICH THE AXIS OF THE PIPE AT THE JOINT DOES NOT DEVIATE FROM THE VERTICAL BY MORE THAN  $\pm 10^\circ$  AND THE PIPE MAY OR MAY NOT BE ROTATED DURING WELDING SO THAT A HORIZONTAL WELD IS PRODUCED AROUND THE ENTIRE CIRCUMFERENCE.

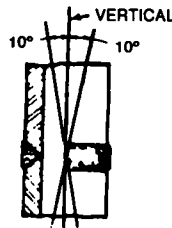

WHEN THE PIPE IS FIXED AND THE AXIS OF THE PIPE AT THE JOINT DEVIATED FROM A HORIZONTAL PLANE BY MORE THAN  $\pm 30^\circ$  AND FROM THE VERTICAL BY MORE THAN  $\pm 10^\circ$ , THE WELDING WILL BE DONE IN A COMBINATION OF HORIZONTAL AND OVERHEAD POSITIONS.

(Vertical Fixed Position-Horizontal Weld)

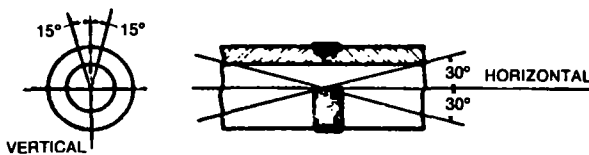

BUTT WELDS IN PIPE IN WHICH THE AXIS OF THE PIPE AT THE JOINT DOES NOT DEVIATE FROM THE HORIZONTAL BY MORE THAN  $\pm 30^\circ$  AND THE PIPE IS FIXED IN THIS POSITION SO THAT THE WELDING IS DONE IN A COMBINATION OF FLAT VERTICAL AND OVERHEAD POSITIONS OF WELDING. (As Shown in the Sketch Above).

(Horizontal Fixed Position-Flat, Vertical, and Overhead Welds)





Statutory Authority: *MS s 326.46*

# MINNESOTA RULES 2007

## 5230.1260 PIPEFITTERS; POWER PIPING SYSTEMS

1042

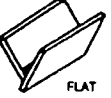
**5230.1260 FIGURE 9: QUALIFYING POSITIONS.**

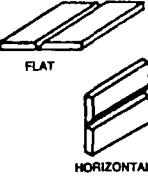
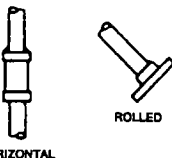
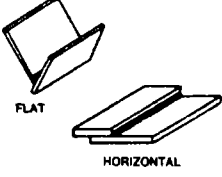
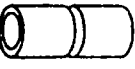
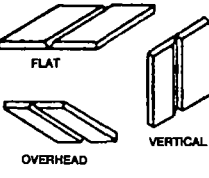
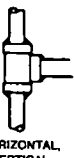
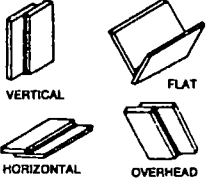
BASIC QUALIFICATION TEST:	GROOVE WELDS IN PLATE	ALSO QUALIFIES FOR:	
		PIPE	FILLET WELDS IN PLATE
 PIPE-HORIZONTAL ROLLED WELD FLAT	 FLAT	 ROLLED	 FLAT
 PIPE-VERTICAL FIXED WELD-HORIZONTAL	 FLAT HORIZONTAL	 HORIZONTAL ROLLED	 FLAT HORIZONTAL
 PIPE-HORIZONTAL FIXED WELD-FLAT, VERTICAL AND OVERHEAD	 FLAT OVERHEAD VERTICAL	 HORIZONTAL, VERTICAL AND OVERHEAD	 VERTICAL FLAT HORIZONTAL OVERHEAD

Qualifying Positions in Groove Welds in Pipe and Corresponding Allowable Working Positions in Groove Welds in Plate and Fillet Welds in Pipe and Plate

**Statutory Authority:** *MS s 326.46*

**5230.1270 ORDER OF REMOVAL OF TEST SPECIMENS.**

Subpart 1. Figure 10.

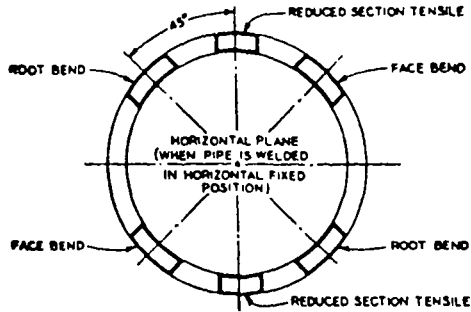

Order of Removal of Test Specimens From Welded Pipe (For Pipe 1/16 to 3/4 in. Thick).

Subp. 2. Figure 11.

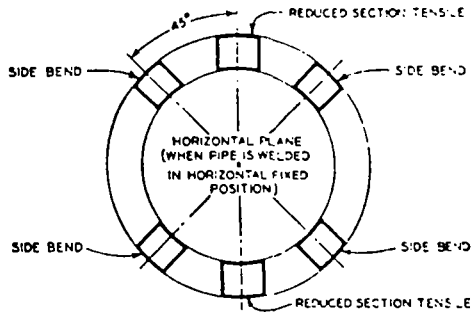

Order of Removal of Test Specimens from Welded Pipe (For Pipe over 3/4 in. Thick)\*  
\*May be used also for Thicknesses 3/8 in to 3/4 in.

**Statutory Authority:** *MS s 326.46*

**AMMONIA REFRIGERATION SYSTEMS**

**5230.5000 MINIMUM STANDARDS.**

Parts 5230.5000 to 5230.6200 form the code for ammonia refrigeration systems and applies to ammonia piping systems used for closed circuit refrigeration systems. Parts 5230.5000 to 5230.6200 are minimum standards and are not intended to be used as or considered as a system design manual except as otherwise specified. If a system has any component designed for temperatures below minus 20 degrees Fahrenheit (minus 28.9 degrees centigrade), then the entire system, including components, must meet the test requirements of the American Society of Mechanical Engineers, American National Standards Institute, B31.5 refrigerating systems for operating at temperatures below minus 20 degrees Fahrenheit (minus 28.9 degrees centigrade).

**Statutory Authority:** *MS s 326.46*

**History:** *17 SR 438*

**5230.5010 INCORPORATIONS BY REFERENCE.**

Items A to E are documents incorporated by reference in parts 5230.5000 to 5230.6200 to the extent of the cited references. The documents are subject to frequent change and are available through the Minitex interlibrary loan system.

A. 1989 American Society of Mechanical Engineers Boiler and Pressure Vessel Code, section VIII, division 1 and section IX; 1989 American Society of Mechanical Engi-

neers, American National Standards Institute, standard B31.5, refrigeration piping; and 1989 American Society of Mechanical Engineers, American National Standards Institute, standard A13.1 scheme for the identification of piping. American Society of Mechanical Engineers, 345 East 47th Street, New York, New York 10017.

B. 1990 American Welding Society, Structural Welding Code—Steel, American National Standards Institute, standard D1.1–90. American Welding Society, 550 Northwest LeJeune Road, Post Office Box 351040, Miami, Florida 33135.

C. 1989 American National Standards Institute, standard Z87.1, Practice for Occupational and Educational Eye and Face Protection, American National Standards Institute, Inc., 1430 Broadway, New York, New York 10018.

D. 1990 Annual Book of American Society for Testing and Materials, Volume 01.01, Steel – Piping, Tubing, Fittings, Publication Number: 01–010190–02, American Society for Testing and Materials, 100 Barr Harbor Drive, West Conshohocken, PA 19428–2959.

**Statutory Authority:** *MS s 326.46*

**History:** *17 SR 438*

### 5230.5015 AMMONIA TASK FORCE.

When a technical organization recognized by the ammonia industry, for example, the American Society of Mechanical Engineers, International Institute for Ammonia Refrigeration, or the American Society of Heating, Refrigeration and Air Conditioning Engineers, adopts substantial changes or modifications in nationally recognized standards for ammonia, a task force of industry representatives may be appointed by the commissioner of the Department of Labor and Industry. The purpose of the ammonia task force will be to review the changes in the standards and to recommend to the commissioner the adoption of applicable changes.

**Statutory Authority:** *MS s 326.46*

**History:** *17 SR 438*

### 5230.5020 DEFINITIONS.

Subpart 1. **Scope.** For purposes of parts 5230.5000 to 5230.6200, the following terms are defined in this part.

Subp. 2. **Accessible.** “Accessible” means to be accessible for inspection or service, such as exposed in shafts, tunnels, or concealed by readily removable construction.

Subp. 3. **Administrative authority.** “Administrative authority” means the inspection agency authorized to inspect high pressure piping under Minnesota Statutes, sections 326.46 and 326.47, subdivision 2.

Subp. 4. **Air cooled condenser.** “Air cooled condenser” means a condenser, including methods for forcing air circulation over the external surface of the condenser coil, for the heat removal necessary to liquify refrigerant vapor on the inside of the tubes.

Subp. 5. **Air cooled desuperheater.** “Air cooled desuperheater” means that part of the system designed to cool the ammonia refrigerant vapor after it is discharged from the compressor and before it enters the condenser with a means of forcing air circulation over the external surface of the desuperheater coil for the heat removal necessary to cool the refrigerant vapor on the inside of the tubes. It does not include desuperheaters that are integral components of condensers.

Subp. 6. **Anhydrous ammonia.** “Anhydrous ammonia,” as used in parts 5230.5000 to 5230.6200, refers to the compound formed by a combination of two gaseous elements, nitrogen and hydrogen. Anhydrous ammonia may be in either gaseous or liquid form. It does not include aqua ammonia (unless as part of a mechanical refrigeration system) which is a solution of ammonia gas in water. When the term ammonia appears, it refers to refrigerant grade anhydrous ammonia, refrigerant 717 (R 717). Anhydrous ammonia also includes mixtures of ammonia and other substances which may act to dilute the ammonia for refrigeration.

Subp. 7. **Approved.** “Approved” means acceptable to the administrative authority having jurisdiction under Minnesota Statutes, sections 326.46 and 326.47, subdivision 2, the

building inspector under Minnesota Statutes, sections 16B.61 and 16B.62, the electrical inspector under Minnesota Statutes, section 326.241, or the plumbing inspector under Minnesota Statutes, section 326.37.

Subp. 8. **An approved nationally recognized testing laboratory.** “An approved nationally recognized testing laboratory” means a laboratory that provides uniform testing and examination procedures under established standards, has personnel with recognized credentials, is properly organized, equipped, and qualified for testing, and has a follow-up inspection service of the current production of the listed products.

Subp. 9. **Automatic expansion valve.** “Automatic expansion valve” means a controlling device that regulates the flow of volatile liquid refrigerant into an evaporator of a refrigeration system and that is actuated toward opening by a lowering of the evaporator pressure below the setting of the valve spring.

Subp. 10. **Automatic liquid refrigerant drain valve.** “Automatic liquid refrigerant drain valve” has the meaning given a high side float valve in subpart 31.

Subp. 11. **Brine.** “Brine” means any liquid used for the transmission of heat without a change in its state.

Subp. 12. **Check valve.** “Check valve” means a control device that permits fluid to flow through the device in one direction, but prevents return of the fluid in the opposite direction.

Subp. 13. **Companion valve or block valve.** “Companion valve” or “block valve” means pairs of mating stop valves, valving off sections of systems, arranged so that the sections may be joined before opening the valves or separated after closing them.

Subp. 14. **Compressor.** “Compressor” means a specific machine, with or without accessories, for compressing refrigerant vapor. A booster compressor is a compressor, with or without accessories, for compressing ammonia refrigerant vapor and discharging to the suction system of a higher stage compressor.

Subp. 15. **Compressor unit.** “Compressor unit” means a condensing unit less the condenser and liquid receiver.

Subp. 16. **Condenser.** “Condenser” means that part of the system designed to liquify refrigerant vapor by removal of heat.

Subp. 17. **Condenser coil.** “Condenser coil” means that part of a condenser constructed of pipe or tubing other than a shell and tube or shell and coil type.

Subp. 18. **Condensing unit.** “Condensing unit” means a specific refrigerating machine combination consisting of one or more power-driven compressors, condensers, liquid receivers when required, and the regularly furnished accessories.

Subp. 19. **Container.** “Container” means a cylinder for the transportation of ammonia refrigerant.

Subp. 20. **Design pressure.** “Design pressure” means the maximum allowable working pressure for which a specific part of a system is designed.

Subp. 21. **Downstream pressure regulator.** “Downstream pressure regulator” means a controlling device that regulates the flow of refrigerant gas or liquid or oil through the device from a section of the system to a lower pressure section of the system and that is actuated toward open by a pressure falling below regulator set-point downstream of the regulator orifice.

Subp. 22. **Duct.** “Duct” means a tube or conduit used for conveying air. The air passages of self-contained systems are not air ducts.

Subp. 23. **Evaporator.** “Evaporator” means that part of the system designed to vaporize liquid refrigerant to produce refrigeration effect.

Subp. 24. **Evaporative condenser.** “Evaporative condenser” means a condenser that obtains cooling effect by the evaporation of water in an air stream on the external surface of the tubes for the heat removal necessary to liquify refrigerant vapor on the inside of the tubes.

Subp. 25. **Evaporator pressure regulator.** “Evaporator pressure regulator” means a controlling device that regulates the flow of primarily gaseous refrigerant from an evapora-



tor section of the system into a lower pressure section and that is actuated toward open by a pressure above set-point ahead of the valve.

Subp. 26. **Exit.** “Exit” means a confined passageway immediately adjacent to the door through which people leave a building.

Subp. 27. **Field test.** “Field test” means a test performed in the field to prove system tightness.

Subp. 28. **Forced feed oil lubrication.** “Forced feed oil lubrication” means that oil is positively provided for lubrication by internal or external mechanical oil pump. It does not include splash-type or drip-type compressor lubrication systems.

Subp. 29. **Flow regulator.** “Flow regulator” means a controlling device that regulates the flow of liquid refrigerant through the device from a section of the system to a lower pressure section of the system and that is actuated by flow rate changes to maintain a predetermined flow rate.

Subp. 30. **High side.** “High side” means the parts of an ammonia refrigerating system subjected to condenser pressure.

Subp. 31. **High side float valve.** “High side float valve” means a controlling device that regulates the flow of volatile liquid refrigerant from a higher pressure section of the system into a lower pressure section and that is actuated toward open by a rising liquid level upstream of the valve.

Subp. 32. **Hot gas bypass regulator.** “Hot gas bypass regulator” means a controlling device that regulates the flow of refrigerant hot gas through the device from a higher pressure section of the system to a lower pressure section of the system and that is actuated toward open by a pressure falling below regulator set-point downstream of the regulator orifice.

Subp. 33. **Inaccessible.** “Inaccessible” means those sections of piping systems installed in walls, floors, ceiling, or other areas where access cannot be made without the removal of permanent construction.

Subp. 34. **Internal gross volume.** “Internal gross volume” means the volume determined from internal dimensions of the container as if the internal parts of the container were not there.

Subp. 35. **Listed.** “Listed” means equipment that has been tested and is identified as acceptable by an approved nationally recognized testing laboratory.

Subp. 36. **Liquid receiver.** “Liquid receiver” means a pressure vessel permanently connected to a refrigerating system by inlet and outlet pipes for storage of liquid refrigerant.

Subp. 37. **Low side.** “Low side” means the parts of a refrigerating system subjected to evaporator pressure.

Subp. 38. **Liquid line.** “Liquid line” means the parts of the system subjected to condenser pressure including those parts where the piping is partly or wholly filled with liquid refrigerant.

Subp. 39. **Low side float valve.** “Low side float valve” means a controlling device that regulates the flow of volatile liquid refrigerant into an evaporator pressure section of the system from a higher pressure section and that is actuated toward closed by a rising liquid level downstream of the valve.

Subp. 40. **Machinery.** “Machinery” means the refrigerating equipment forming a part of the refrigerating system, including but not limited to any or all of the following:

- A. compressor;
- B. condenser;
- C. liquid receiver;
- D. connecting piping; or
- E. evaporator.

Subp. 41. **Machinery room.** “Machinery room” means a room in which a refrigerating system is permanently installed and operated with a one-hour fire separation from the rest of

the building, but not including evaporators located in a cold storage room, refrigerator box, air-cooled space, or other enclosed space. A machinery room is defined as being in a building, part of a building, attached to a building, adjacent to a building, or detached and separate from a building. An independent mechanical ventilation system that complies with part 5230.5710 must be provided.

Closets solely contained within, and opening only into, a room are not considered to be machinery rooms, but must be considered a part of the machinery room in which they are contained or open into. Spaces in which a self-contained system is located are not classified as a machinery room.

Machinery rooms must comply with part 5239.5705. Machinery rooms must have a floor drain and backflow preventer that complies with the Minnesota State Plumbing Code, chapter 1355. For the purposes of parts 5230.5000 to 5230.6200, machinery room and equipment room have the same meaning.

Subp. 42. **Machinery room, restricted.** "Machinery room, restricted" means a machinery room as defined by subpart 41 that complies with the specific requirements of items A to H:

A. any doors opening into the building must be approved self-closing, tight-fitting fire doors;

B. the walls, floor, and ceiling must be tight and of not less than one-hour fire-resistant construction and all penetrations must be fire stopped;

C. it must have an exit door that opens directly to the outer air or through a vestibule-type exit equipped with self-closing, tight-fitting doors;

D. exterior openings, if present, must not be under any fire escape or any open stairway;

E. pipes piercing the interior walls, ceiling, or floor of a room must be tightly sealed and fire stopped to the walls, ceiling, or floor through which they pass;

F. emergency remote controls to stop the action of the refrigerant compressor must be provided and be located immediately outside the machinery room;

G. emergency remote controls for the mechanical means of ventilation must be provided and be located outside the machinery room; and

H. no permanently installed flame-producing device or hot surface above 800 degrees Fahrenheit (426.5 degrees centigrade) shall be permitted in the restricted machinery room.

Subp. 43. **Manufacturer.** "Manufacturer" means the company or organization that affixes its name or nationally registered trademark or trade name to the refrigeration equipment concerned.

Subp. 44. **Mechanical joint.** "Mechanical joint" is a gas-tight joint, obtained by the joining of metal parts through a positive holding mechanical construction that is designed and manufactured as suitable for ammonia service.

Subp. 45. **Mechanical refrigeration system.** "Mechanical refrigeration system" means a combination of interconnected refrigerant containing parts constituting one closed refrigerant circuit in which a refrigerant is circulated to extract heat and in which a compressor is used for compressing the ammonia refrigerant vapor.

Subp. 46. **Motorized valve.** "Motorized valve" means a device that regulates the flow of fluid through the device by a motor that moves a plug with respect to an orifice.

Subp. 47. **Nameplate.** "Nameplate" means a metallic plate, suitably and legibly etched or stamped. The size of type must be no smaller than ten point and the plate must be permanently attached in a readily accessible location. The nameplate must contain the information required in parts 5230.5615 to 5230.5640.

Subp. 48. **Nonpositive displacement compressor.** "Nonpositive displacement compressor" means a compressor in which an increase in vapor pressure is attained without changing the internal volume of the compression chamber.

Subp. 49. **Oil drain float valve.** "Oil drain float valve" has the meaning given high side float valve in subpart 31. This reference does not cover control of oil in the system.

Subp. 50. **Pilot operated valve.** “Pilot operated valve” means the valve that regulates flow in response to a signal from a pilot.

Subp. 51. **Piping.** “Piping” means the pipe or tube mains for interconnecting the various parts of a refrigerating system. Piping means the piping system, including:

A. pipe;

B. flanges;

C. bolting;

D. gaskets;

E. valves;

F. fittings;

G. the pressure containing parts of other components such as expansion joints, strainers, and devices that serve such purposes as mixing, separating, snubbing, distributing, metering, or controlling flow;

H. piping supporting fixtures; and

I. structural attachments.

Subp. 52. **Positive displacement compressor.** “Positive displacement compressor” means a compressor in which an increase in pressure is attained by changing the internal volume of the compression chamber.

Subp. 53. **Pressure imposing element.** “Pressure imposing element” means any device or portion of the equipment used to increase the refrigerant vapor pressure.

Subp. 54. **Pressure relief device.** “Pressure relief device” means a reseating type pressure actuated valve designed to automatically relieve excessive pressure.

Subp. 55. **Pressure relief valve or safety valve.** “Pressure relief valve” is also called a “safety valve” and means a reseating type pressure actuated valve held closed by a spring or other means and designed to automatically relieve pressure in excess of its setting.

Subp. 56. **Pressure vessel.** “Pressure vessel” means any refrigerant containing receptacle of a refrigerating system other than evaporators, where each separate section of the evaporator does not exceed one-half foot<sup>3</sup> (0.014 meter<sup>3</sup>) of refrigerant containing volume, evaporator coils, compressors, condenser coils, controls, headers, pumps, and piping.

Subp. 57. **Readily accessible.** “Readily accessible” means capable of being reached safely and quickly for operation, repair, or inspection without requiring those to whom ready access is requisite to climb over or remove obstacles, or to resort to the use of portable access equipment and tools.

Subp. 58. **Refrigerant.** “Refrigerant” means a substance used to produce refrigeration by its expansion or vaporization.

Subp. 59. **Refrigerant pressure activated condenser water regulator.** “Refrigerant pressure activated condenser water regulator” means a device that regulates the flow of cooling water through the device to or from a water-cooled condenser and that is actuated toward open by refrigerant high side pressure rising above the regulator set point.

Subp. 60. **Refrigerant pump.** “Refrigerant pump” means a mechanical device for moving liquid ammonia refrigerant within a closed circuit mechanical refrigeration system.

Subp. 61. **Rupture member.** “Rupture member” means a device designed to rupture at a predetermined pressure. Rupture members are prohibited.

Subp. 62. **Saturation pressure.** “Saturation pressure” of a refrigerant is the pressure at which there is stable coexistence of the vapor and liquid or the vapor and solid phase.

Subp. 63. **Self-contained system.** “Self-contained system” means a complete factory-made and factory-tested system in a suitable frame or enclosure that is fabricated and shipped in one or more sections and in which no refrigerant-containing parts are connected in the field other than by companion or block valves.

Subp. 64. **Shell and tube condenser.** “Shell and tube condenser” means a type of condenser where tubes in a bundle with each end secured in a tube sheet are enclosed in a shell

with refrigerant in the shell. A shell and tube condenser with refrigerant in the shell is a pressure vessel.

Subp. 65. **Shell and tube evaporator.** “Shell and tube evaporator” means a type of evaporator where tubes or coils are enclosed in a shell. Flooded type has the evaporating ammonia in the shell. Direct expansion type has the evaporating ammonia in the tubes or coils.

Subp. 66. **Solenoid valve.** “Solenoid valve” means a valve that is opened or closed by the magnetic action of an electrically energized coil. The opposite action is accomplished by gravity, pressure, or spring action.

Subp. 67. **Stop valve.** “Stop valve” means a device to shut off the flow.

Subp. 68. **Test pressure.** “Test pressure” means the minimum pressure, pounds per square inch gage, to which a specific part is subjected under test condition.

Subp. 69. **Thermostatic expansion valve.** “Thermostatic expansion valve” means a controlling device that regulates the flow of volatile refrigerant into an evaporator of a refrigeration system and which is actuated by changes in evaporator pressure and superheat of the refrigerant gas leaving the evaporator. Its basic response is to superheat.

Subp. 70. **Three-way type stop valve.** “Three-way type stop valve” means a manually operative valve with one inlet that alternately can stop flow to either of two outlets.

Subp. 71. **Ultimate strength.** “Ultimate strength” means the highest stress level that the component can tolerate without rupture.

Subp. 72. **Unprotected tubing.** “Unprotected tubing” means tubing that is not protected by enclosure or suitable location so that it is exposed to crushing, abrasion, puncture, or similar mechanical damage under installed conditions.

Subp. 73. **Upstream pressure regulator.** “Upstream pressure regulator” means a controlling device that regulates the flow of refrigerant gas or liquid or oil through the device from a section of the system to a lower pressure section of the system and that is actuated toward open by a pressure rising above regulator set-point upstream of the regulator orifice.

Subp. 74. **Welded joint.** “Welded joint” means a gas-tight joint, obtained by the joining of metal parts in molten state.

**Statutory Authority:** *MS s 326.46*

**History:** *17 SR 438*

### 5230.5025 AMMONIA GOVERNED AND DEFINED.

Ammonia is defined in part 5230.5020, subpart 6. Only refrigerant grade ammonia may be used in ammonia refrigerant systems. The maximum allowable concentration of ammonia in refrigeration systems is 50 parts per million ambient. The ammonia must be clear, colorless liquid or gas free from visible impurities. Refrigeration grade anhydrous ammonia must contain at least 99.95 percent pure ammonia for charging both new and old refrigeration systems.

The flammable limits at atmospheric pressure are 16 percent and 25 percent by volume of ammonia in air. An ammonia-air mixture in an iron flask does ignite at 1204 degrees Fahrenheit (651 degrees centigrade). The addition of refrigerant oil to ammonia, when released from the system, can act to increase the hazard of combustion.

At 50 parts per million, its odor is detectable by most people. Since ammonia gas is lighter than air, adequate ventilation is the best means of preventing an accumulation of ammonia.

The physical properties and specifications of refrigerant grade ammonia are:

#### PHYSICAL PROPERTIES OF AMMONIA

ENGLISH	COMMON METRIC	SI
---------	---------------	----

#### A. Molecular symbol

NH <sub>3</sub>	NH <sub>3</sub>	NH <sub>3</sub>
-----------------	-----------------	-----------------

# MINNESOTA RULES 2007

## 5230.5025 PIPEFITTERS; POWER PIPING SYSTEMS

1050

B. Molecular weight	1.7.032	1.7.032	1.7.032
C. Boiling point at one atmosphere*	-28 degrees F	(-33.3 degrees C)	(239.85 degrees K)
D. Freezing point at one atmosphere*	-108 degrees F	(-77.6 degrees C)	(195.55 degrees K)
E. Critical temperature	271.4 degrees F	(133 degrees C)	(406.15 degrees K)
F. Critical pressure	1657 psig	(116.2 kg/cm)	(11.42 M Pa)
G. Latent heat at -28 degrees Fahrenheit (-33.3 degrees centigrade) and one atmosphere*	589.3 Btu/lb	(332.4 cal/gm)	(13.92 MJ/kg)
H. Relative density of vapor compared to dry air at 32 degrees Fahrenheit (0 degrees centigrade) and one atmosphere*	0.5963	0.5963	0.5963
I. Vapor density at -28 degrees Fahrenheit (-33.3 degrees centigrade) and one atmosphere*	0.05555 lb/ft <sup>3</sup>	(0.889 kg/m)	(0.889 kg/m)
J. Specific gravity of liquid at -28 degrees Fahrenheit (-33.3 degrees centigrade) compared to water at 39.2 degrees Fahrenheit (4 degrees centigrade)	0.6821	0.6821	0.6821
K. Liquid density at -28 degrees Fahrenheit (-33.3 degrees centigrade) and one atmosphere*	42.56 lb/ft	(6.819 kg/m)	(6.819 kg/m)
L. Specific volume of vapor at 32 degrees Fahrenheit (0 degrees centigrade) and one atmosphere*	20.78 ft/lb	(1.29 m/kg)	(1.29 m/kg)
M. Flammable limits by volume in air at atmospheric pressure	16% to 25%	16% to 25%	16% to 25%
N. Ignition temperatures	1204 degrees F	651 degrees C	(924.15 K)
O. Specific heat, gas 59 degrees Fahrenheit (15 degrees centigrade) one atmosphere*	1. at constant pressure, Cp		
	0.519 btu/lb deg F	0.519 cal/gm C	(2189.0 J/kgK)
	2. at constant volume, Cv		
	0.3995 Btu/lb deg F	0.3995 cal/gm C	(1672 J/kgK)
* One atmosphere equals:			
	14.71 psia	(1.033 Kg/cm)	(101.4 KPa)

Refrigerant grade ammonia must meet the following purity requirements:

(1) ammonia content determined by evaporative residue test, 99.95 percent minimum;

(2) nonbasic gas in vapor phase, 25 parts per million maximum;

(3) nonbasic gas in liquid phase, ten parts per million maximum;

(4) water, 33 parts per million maximum;

(5) oil as soluble in petroleum ether, two parts per million maximum;

(6) salt calculated as NaCl, none; and

(7) pyridine, hydrogen sulfide, naphthalene, none.

**Statutory Authority:** *MS s 326.46*

**History:** *17 SR 438*

### 5230.5250 LOCATIONS GOVERNED AND DEFINED.

Subpart 1. **Locations governed.** Locations governed by parts 5230.5000 to 5230.6200 in which ammonia piping systems may be placed are grouped by occupancy, as defined in subparts 2 to 8.

Subp. 2. **Institutional occupancy.** “Institutional occupancy” applies to that portion of a premise in which persons are confined to receive medical, charitable, education, or other care or treatment, or in which persons are held or detained by reason of public or civic duty, including hospitals, nursing homes, asylums, sanitariums, police stations, jails, courthouses with cells, and similar occupancies.

Subp. 3. **Public assembly occupancy.** “Public assembly occupancy” applies to that portion of a premise in which persons congregate for civic, political, educational, religious, social, or recreational purposes, including armories, assembly rooms, auditoriums, ball-rooms, bath houses, bus terminals, broadcasting studios, churches, colleges, courthouses without cells, dance halls, department stores, exhibition halls, fraternity halls, libraries, lodge rooms, mortuary chapels, museums, passenger depots, schools, skating rinks, subway stations, theaters, enclosed portions of arenas, racetracks, and stadiums and similar occupancies.

Subp. 4. **Residential occupancy.** “Residential occupancy” applies to that portion of a premise in which sleeping accommodations are provided, including clubhouses, convents, dormitories, hotels, lodging houses, multiple story apartments, residences, studios, tenements, and similar occupancies.

Subp. 5. **Commercial occupancy.** “Commercial occupancy” applies to that portion of a premise used for the transaction of business, for the rendering of professional services, for the supplying of food, drink, or other bodily needs and comforts, for manufacturing purposes, or for the performance of work or labor not included under subpart 6, industrial occupancy. Examples of commercial occupancy for work or labor not covered under industrial occupancy are bake shops, fur storage facilities, laboratories, loft buildings, markets, office buildings, professional buildings, restaurants, and stores other than department stores.

Subp. 6. **Industrial occupancy.** “Industrial occupancy” applies to an entire building or premises or to that portion of a building used for manufacturing, processing, or storage of materials or products. Representative examples include chemical, food, candy and ice cream factories, ice-making plants, meat packing plants, refineries, perishable food warehouses and similar occupancies. In an industrial occupancy, when the number of persons in a refrigerated space, served by a direct system, on any floor above the first floor ground level or dock level, exceeds one person per 100 square feet (9.29 square meters) of floor area, the requirements of commercial occupancy apply unless that refrigerated space is provided with the required number of doors opening directly into building exits approved by the building inspector.

The refrigerated space must be cut off from the rest of the building by tight construction of at least one-hour fire rating with tight-fitting doors as required by the Minnesota State Building Code.

This subpart does not prohibit openings for the passage of products from one refrigerated space to another refrigerated space.

For the purpose of this subpart, "approved building exits" means approval according to the standards promulgated by the National Fire Protection Association and as approved by the building inspector having jurisdiction.

Subp. 7. **Mixed occupancy.** "Mixed occupancy" applies to a building occupied or used for different purposes in different parts. When the occupancies are cut off from the rest of the building by tight partitions, floors, ceilings, fire stopped, and protected by self-closing doors, the requirements for each type of occupancy apply for its portion of the building premises. For example, the cold storage spaces in retail frozen food lockers, hotels, and department stores might be classified under industrial occupancy, while other portions of the building would be classified under other occupancies. When the occupancies are not separated, the occupancy carrying the more stringent requirements governs.

Subp. 8. **Adjacent locations.** Placement of ammonia refrigeration equipment, other than piping, installed in locations adjacent to areas described in this part and located outside of, but less than 20 feet (6.10 meters) from any building opening is governed by the occupancy classification of the building. Equipment installed in a nonadjacent location, such as equipment in a separate building located 20 feet (6.10 meters) or more from an opening in any other building, is considered a separate building and is governed by this part.

**Statutory Authority:** *MS s 326.46*

**History:** *17 SR 438*

### 5230.5300 REFRIGERATING SYSTEM CLASSIFICATION BY TYPE.

Subpart 1. **Refrigerating systems.** Refrigerating systems are classified by the method employed for extracting heat in subparts 2 to 4 and as in the drawing in subpart 5.

Subp. 2. **Direct system.** A direct system is one in which the evaporator is in direct contact with the material or space refrigerated or is located in air-circulating passages communicating with these spaces.

Subp. 3. **Double direct system.** A double direct system means one in which an evaporative refrigerant is used in a secondary circuit to condense or cool a refrigerant in a primary circuit.

Subp. 4. **Indirect system.** An indirect system means one in which a brine, cooled by the refrigerant, is circulated to the material or space refrigerated or is used to cool air so circulated. Indirect systems that are distinguished by the type of method of application are described in items A to D.

A. "Indirect open-spray system" means one in which a brine, cooled by an evaporator located in an enclosure external to a cooling chamber, is circulated to a cooling chamber, and is sprayed in the cooling chamber.

B. "Indirect closed surface system" means one in which a brine, cooled by an evaporator located in an enclosure external to a cooling chamber, is circulated to and through a cooling chamber in pipes or other closed circuits.

C. "Indirect vented closed surface system" means one in which a brine, cooled by an evaporator located in a vented enclosure external to a cooling chamber, is circulated to and through a cooling chamber in pipes or other closed circuits.

D. "Double indirect vented open spray system" means one in which a brine, cooled by an evaporator located in a vented enclosure, is circulated through a closed circuit to a second enclosure where it cools another supply of a brine and this liquid in turn is circulated to a cooling chamber and is sprayed in the cooling chamber.

# MINNESOTA RULES 2007

1053

PIPEFITTERS; POWER PIPING SYSTEMS 5230.5300

Subp. 5. **Direct and indirect systems diagram.** The following diagram illustrates direct and indirect refrigerating systems as defined in subparts 1 to 4.

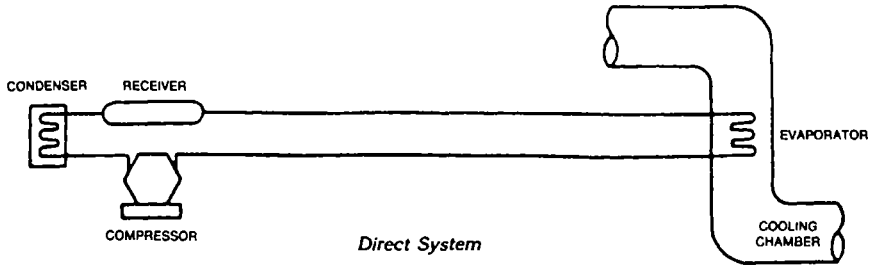

Direct System

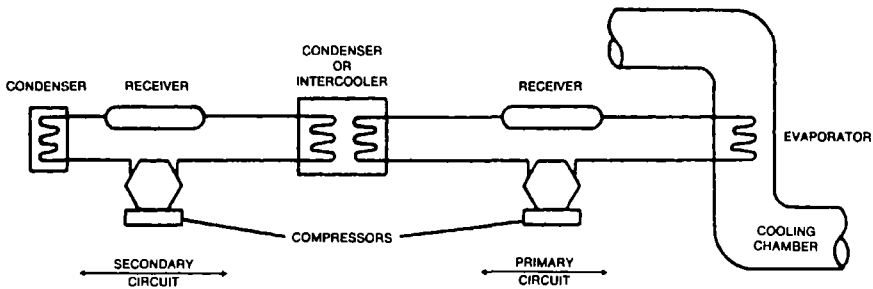

Double Direct System

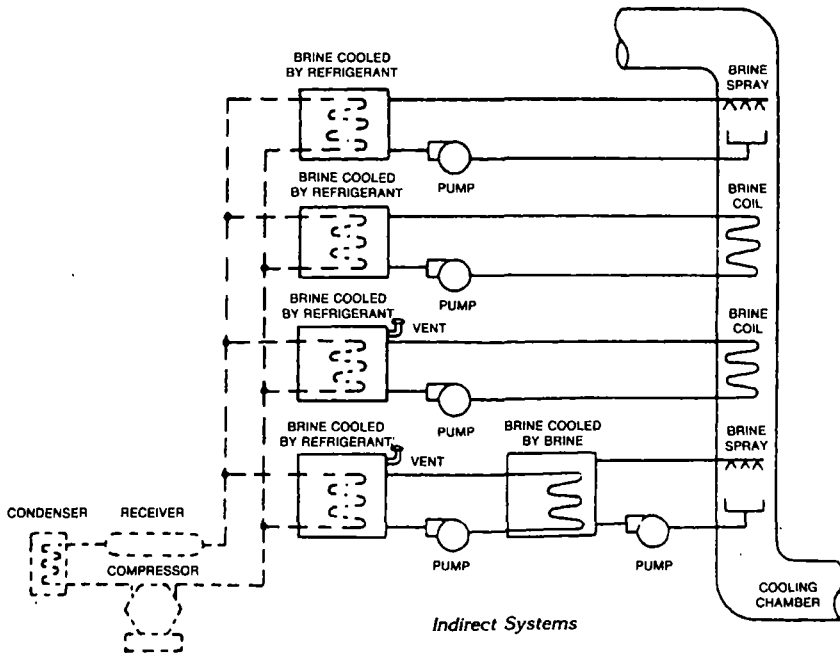

Indirect Systems

Statutory Authority: *MS s 326.46*

History: *17 SR 438*



**5230.5350 RESTRICTIONS ON PLACEMENT OF AMMONIA PIPING, LIMITATIONS ON SYSTEM SIZING, AND PRESSURE RELIEF VENTING REQUIREMENTS.**

Subpart 1. **Scope.** Placement of ammonia piping is restricted according to subparts 2 to 16.

Subp. 2. **Public stairway, stair landing, entrance, or exit.** No portion of an ammonia piping system is permitted to be installed in or on a public stairway, stair landing, entrance, or exit.

Subp. 3. **Public hallway or lobby.** No portion of an ammonia piping system must interfere with free passage through public hallways or lobbies. No portion of a refrigerating system containing ammonia piping is permitted in public hallways or lobbies of institutional or public assembly occupancies. Ammonia piping systems installed in a public hallway or lobby shall be limited to sealed absorption systems containing not more than three pounds (1.36 kilogram) of an ammonia refrigerant when in residential and commercial occupancies.

Subp. 4. **Enclosed space; refrigerant quantity limits.** When the refrigerant-containing parts of an ammonia piping system are located in one or more enclosed spaces, the cubic area of the smallest enclosed occupied space, other than the machinery room, must be used to determine the permissible quantity of refrigerant in the system. Where a refrigerating system has evaporator coils serving individual stories of a building, the story having the smallest volume must be used to determine the maximum quantity of refrigerant in the entire system.

Subp. 5. **Air duct.** When the evaporator is located in an air duct system, the cubic area of the smallest occupied enclosed space served by the air duct system must be used to determine the permissible quantity of refrigerant in the system.

Subp. 6. **Suspended ceiling.** Where the return air space above a suspended ceiling is one continuous space and not an enclosed air duct in which the return air is confined, this space may be included in calculating the cubic area of the occupied space.

Subp. 7. **External venting.** In institutional and public assembly occupancies, direct expansion coils or evaporators used for air conditioning and located downstream from and in proximity to a heating coil, or located upstream within 18 inches (0.46 meter) of a heating coil, must be fitted with a pressure relief device discharging to the outside of the building; except that a relief device shall not be required on units or self-contained systems if the internal volume of the low side of the system that may be shut off by valves, divided by the total weight of refrigerant in the system, less the weight of refrigerant vapor contained in the other parts of the system at 110 degrees Fahrenheit (43.5 degrees centigrade) exceeds the specific volume of the refrigerant at critical conditions of temperature and pressure.

The exemption is stated in formula form as follows:

$$\frac{V1}{(W1-W2)}$$

\*V1/W1-W2 shall be more than Vgc where V1 equals low side volume, cubic feet (cubic meter)

\*Vgc equals specific volume at critical conditions of temperature and pressure, cubic feet per pound (cubic meter per kilogram)

\*W1 equals total weight of refrigerant in system, pound (kilogram)

\*V2 equals total volume of system less V1 cubic foot (cubic meter)

\*Vgt equals specific volume of refrigerant vapor at 110 degrees Fahrenheit (43.5 degrees centigrade), foot<sup>3</sup>/pound cubic (meter<sup>3</sup>/kilogram)

\*W2 equals V2/Vgt equals weight of refrigerant vapor in V2 at 110 degrees Fahrenheit (43.5 degrees centigrade)

Subp. 8. **Maximum quantities.**

A. Direct systems containing ammonia refrigerants must not be used for air conditioning for human comfort. For other applications, the maximum permissible quantity of ammonia refrigerants in a direct system must be as specified in subpart 9.

B. fans, drives, and motors must be protected with screens or guards according to safety standards set by Occupational Safety and Health Division, Department of Labor and Industry, general requirement for all machines, and mechanical power transmission apparatus, chapter 5205;

C. propeller, axial, or centrifugal fan speeds must not exceed the safe design speed recommended by the manufacturer for the temperature and nature of the application;

D. manufacturers producing evaporator coils with fans and motors must provide the following minimum data on the nameplate:

- (1) manufacturer's name and trademark;
- (2) year of manufacture;
- (3) design pressure;
- (4) electrical full load amps for all components;
- (5) volts, hertz, and phase;
- (6) refrigerant ammonia;
- (7) identification number; and
- (8) model designation number.

**Subp. 3. Design criteria, shell and tube evaporators, flooded type.** The design criteria for flooded type refrigerant in shell is as follows:

A. the shell side in the pressure vessel must be provided with adequate openings for the attachment of safety relief devices according to parts 5230.5660 and 5230.5665;

B. minimum design pressure must be 150 pounds per square inch gage (10.54 kilogram/cm<sup>2</sup> gage) (1034.0 kPa gage);

C. the manufacturer's producing shell and tube evaporators for refrigerants in the shell must provide the following minimum data on the nameplate:

- (1) manufacturer's name;
- (2) shell maximum allowable working pressure ..... at ..... temperature;
- (3) tube maximum allowable working pressure ..... at ..... temperature;
- (4) manufacturer's serial number;
- (5) year of manufacture;
- (6) national board number where applicable;
- (7) American Society of Mechanical Engineers stamp;
- (8) an additional pressure and temperature stamping is required for vessels

used below minus 20 degrees Fahrenheit (minus 28.9 degrees centigrade) that are not impact tested; and

- (9) manufacturer's model number.

**Subp. 4. Design criteria, shell and tube evaporators, direct expansion type with refrigerant in tubes.** The design criteria for direct expansion type with refrigerant in tubes is as follows:

A. tube must comply with rules of American Society of Mechanical Engineers Boiler and Pressure Vessel Code, section VIII, or American National Standards Institute B31.5, whichever applies;

B. tube side minimum design pressure must be 150 pounds per square inch gage (10.54 kilogram/cm<sup>2</sup> gage) (1034.0 kPa gage); and

C. manufacturers producing shell and tube evaporators for refrigerants in the tube must provide the following minimum data on the nameplate:

- (1) manufacturer's name;
- (2) shell maximum allowable working pressure ..... at ..... temperature;
- (3) tube maximum allowable working pressure ..... at ..... temperature;
- (4) manufacturer's serial number;
- (5) year of manufacture;
- (6) national board number where applicable;
- (7) American Society of Mechanical Engineers stamp;

(8) an additional pressure and temperature stamping is required for vessels used below minus 20 degrees Fahrenheit (minus 29.9 degrees centigrade) that are not impact tested; and

(9) manufacturer's model number.

Statutory Authority: *MS s 326.46*

History: *17 SR 438*

#### 5230.5640 REFRIGERANT PUMP.

Subpart 1. **Generally.** This part applies to mechanical pumps used in closed circuit ammonia refrigeration systems.

Subp. 2. **Design criteria, refrigerant pumps.** The design criteria for refrigerant pumps is as follows:

A. A hydrostatic or differential pressure relief device or noncloseable vent pipe must be used for pressure protection of a liquid pump and its associated piping. The inlet connection for the relief device or vent pipe must be located on the pump casing or piping between the stop valves at the pump inlet and outlet, except that when a check valve is located between the pump and its outlet stop valve, the relief device or vent pipe inlet must be connected to the pipe between the discharge check valve and stop valve. No check valve may be installed that will isolate a liquid line solenoid in the pump discharge from the relief valve.

The relief device or vent pipe must connect either to the pump suction line upstream of the pump suction stop valve or to the vessel to which the pump suction is connected. This relief device or vent pipe must be external to the pump housing.

B. The pump casing minimum design pressure must be 150 pounds per square inch gage (10.54 kilogram/cm<sup>2</sup> gage) (1034.0 kPa gage) for low side service and 250 pounds per square inch gage (17.57 kilogram/cm<sup>2</sup> gage) (1724.0 kPa gage) for high side service with water cooled condensing and 300 pounds per square inch gage (21.09 kilogram/cm<sup>2</sup> gage) (2068.9 kPa gage) with air cooled condensing.

C. Pump drives and motors must be protected with screens or guards according to the standards of Occupational Safety and Health Division, Department of Labor and Industry, general requirements for all machines, and mechanical power transmission apparatus, chapter 5205.

D. A pump must be provided with controls that provide for the starting only when the pump is unloaded. Pumps must be installed with adequate electrical service and controls to start and run safely and operate in conformity with manufacturers recommendations.

E. Manufacturers producing ammonia pumps must permanently affix to the pump a nameplate providing the following minimum data on the nameplate:

- (1) manufacturer's name;
- (2) refrigerant ammonia;
- (3) maximum working pressure;
- (4) minimum allowable refrigerant temperature;
- (5) maximum speed of pump;
- (6) maximum horsepower of pump; and
- (7) manufacturer's model number.

Statutory Authority: *MS s 326.46*

History: *17 SR 438*

#### 5230.5645 REFRIGERATION CONTROL VALVES.

Subpart 1. **Generally.** This part applies to control valves that contain or that are directly and automatically actuated by the ammonia refrigerant or its associated lubricating oil.

Products covered are solenoid valves, thermostatic expansion valves, automatic expansion valves, high side float valves, low side float valves, oil drain float valves, automatic liquid refrigerant drain valves, evaporator pressure regulators, downstream pressure regulators, hot gas bypass regulators, check valves, motorized valves, flow regulators, pilot operated and refrigerant pressure actuated condensing water regulators.

Refrigeration control valves contained within the refrigerant containing envelope for other equipment such as slide valves in screw compressors are not covered in this part.

**Subp. 2. Design criteria, refrigeration control valves.** The design criteria for refrigeration control valves are as follows:

A. The minimum design pressure for refrigeration control valves for water cooled condensing systems is 250 pounds per square inch gage (17.57 kilograms/cm<sup>2</sup> gage) (1724.0 kPa gage).

B. The minimum design pressure for refrigeration control valves for air cooled condensing systems is 300 pounds per square inch gage (21.09 kilogram/cm<sup>2</sup> gage) (2068.0 kPa gage).

C. The pressure requirements of this part apply to fluid and ambient temperatures of minus 20 degrees Fahrenheit (minus 28.9 degrees centigrade) to 450 degrees Fahrenheit (232.2 degrees centigrade).

D. For temperatures below minus 20 degrees Fahrenheit (minus 28.9 degrees centigrade), use American National Standards Institute B31.5, Code of Refrigerant Piping.

E. This part does not apply to any system with temperatures exceeding 450 degrees Fahrenheit (323.2 degrees centigrade).

F. Connection style, design, and fabrication for main and auxiliary connections must permit leaktight field installation without reducing the pressure requirements of this part and parts 5230.5900 to 5230.5960.

G. Manufacturers producing refrigeration control valves shall provide the following minimum data on the nameplate:

- (1) manufacturer's name;
- (2) serial number;
- (3) volts;
- (4) amperes;
- (5) hertz;
- (6) manufacturer's model number;
- (7) pressure rating; and
- (8) ammonia service.

**Subp. 3. Functional test.** A completely assembled control valve must be given a bench test by the manufacturer using air or other suitable fluid that simulates the field performance of the moving parts of the valve in a manner that will determine that the completed device actually functions.

**Subp. 4. Leakage test.** A completely assembled control valve must be given a bench test by the manufacturer using air or other suitable fluid that enables observation of the leakage through the device when in a nominally closed position.

**Subp. 5. Pressure test.** A completely assembled control valve must be given a pressure test by the manufacturer at not less than the pressure required in part 5230.6100. The entire envelope of the device must exhibit zero leakage under this pressure when subject to inspection under clean water or other suitable liquid or other leakage detection method of equal or greater sensitivity.

**Statutory Authority:** *MS s 326.46*

**History:** *17 SR 438*

## 5230.5650 CONTROLS; ELECTRIC; PNEUMATIC.

**Subpart 1. Generally.** This part applies to sensing devices that initiate control pulses or signals applied for use in ammonia closed circuit refrigeration systems.

**Subp. 2. Design criteria.** The minimum high side design pressure is:

A. Water cooled or evaporative condensing: 250 pounds per square inch gage (17.57 kilograms/cm<sup>2</sup> gage) (1724.0 kPa gage).

B. Air cooled condensing: 300 pounds per square inch gage (21.09 kilograms/cm<sup>2</sup> gage) (2068.0 kPa gage). Minimum design pressure low side: 150 pounds per square inch gage (10.54 kilogram/cm<sup>2</sup> gage) (1034.0 kPa gage).

Subp. 3. **Nameplate data.** Manufacturers producing electrical and pneumatic controls must provide the following minimum data on the nameplate:

- A. manufacturer's name;
- B. volts;
- C. amperes;
- D. hertz;

E. any special characteristics of a control device is to be noted either on the nameplate or in the accompanying literature; and

- F. manufacturer's model or serial number.

*Statutory Authority: MS s 326.46*

*History: 17 SR 438*

#### 5230.5655 PRESSURE RELIEF DEVICES.

Subpart 1. **Generally.** This part applies to pressure relief devices installed on ammonia closed circuit refrigeration systems, for the purpose of safely relieving excess pressure due to fire or other abnormal conditions. Rupture members are not allowed under this chapter.

Subp. 2. **Standards for valves.** An ammonia refrigerating system must be protected by a pressure relief device and also must comply with the specific requirements in parts 5230.5900 to 5230.5960. They must be reseating type only. No rupture members shall be used.

Subp. 3. **Pressure actuation required.** A pressure relief device must be directly pressure actuated. Each part of a refrigerating system that can be valved off, and that contains one or more pressure vessels having internal diameters greater than three inches (76 millimeters) and containing liquid refrigerant, must be protected by a pressure relief device.

Subp. 4. **Stop valves.** Stop valves must not be located between the means of pressure relief and the part or parts of the system protected, except when the stop valve is of the three-way type connected in series to two parallel relief devices in a manner that both relief devices cannot be shut off from the system at the same time.

Subp. 5. **Pressure relief devices.** A pressure relief device must be connected above the liquid refrigerant level, and as nearly as practicable, directly to the pressure vessel or other parts of the system protected. The device must be installed so that it is readily accessible for inspection and repair. Condensers must be protected by relief devices on circuits that could be valved off.

Subp. 6. **Hydrostatic pressure relief.** Hydrostatic pressure relief devices must meet the requirements of part 5230.5945.

*Statutory Authority: MS s 326.46*

*History: 17 SR 438*

#### 5230.5660 SETTING OF PRESSURE RELIEF DEVICES.

Subpart 1. **Pressure relief valve setting.** Pressure relief valves must be set to start to function at a pressure not more than the design pressure of the parts of the system protected.

Subp. 2. **Marking of relief devices.** A pressure relief valve for refrigerant containing components shall be set and sealed by the manufacturer. A pressure relief valve must be marked by the manufacturer with the data required in the American Society of Mechanical Engineers Boiler and Pressure Vessel Code, Section VIII, Division 1, except that relief valves for systems with design pressures of 15 pounds per square inch gage (10.54 kilograms/cm<sup>2</sup> gage) (103.4 kPa gage) or less may be marked by the manufacturer with the pressure setting and capacity and comply with part 5230.5945.

*Statutory Authority: MS s 326.46*

*History: 17 SR 438*

#### 5230.5665 PRESSURE VESSEL PROTECTION.

Subpart 1. **Provision for pressure relief protection pressure.** Pressure vessels must be provided with pressure relief protection according to American Society of Mechanical

Engineers Boiler and Pressure Vessel Code, Section VIII, Division 1. Piping requirements are governed by part 5230.5945.

**Subp. 2. Design criteria, pressure vessels of less than ten feet<sup>3</sup> (0.28 meter<sup>3</sup>) internal gross volume.** Except as specified in this part, a pressure vessel containing liquid ammonia refrigerant with internal gross volume less than ten feet<sup>3</sup> (0.28 meter<sup>3</sup>), which may be shut off from the other parts of a refrigerating system, must be protected by a pressure relief device having sufficient capacity to prevent the pressure in the vessel from rising more than ten percent above the setting of the pressure relief device.

**Subp. 3. Design criteria, pressure vessels of more than ten feet<sup>3</sup> (0.28 meter<sup>3</sup>) internal gross volume.** A pressure vessel ten feet<sup>3</sup> (0.28 meter<sup>3</sup>) gross or over must be protected by two parallel pressure relief devices connected to a three-way type stop valve as required by part 5230.5655. A pressure relief valve must have sufficient capacity to prevent the pressure in the pressure vessel from rising more than ten percent above the setting of the pressure relief valve.

**Subp. 4. High side to low side pressure relief protection, pressure relief valves discharging into low side of the system.** A single relief valve, not rupture member, of the required relieving capacity may be used on vessels of ten feet<sup>3</sup> (0.28 meter<sup>3</sup>) or over.

**Subp. 5. Parallel pressure relief devices on large vessels.** Except as specified in this part in cases where large pressure vessels containing liquid refrigerant require the use of two or more pressure relief devices in parallel to obtain the capacity required, the battery of pressure relief devices must be considered as a unit and as one pressure relief device.

**Subp. 6. Pressure relief protection for evaporator pressure vessels.** A pressure relief device for a pressure vessel used as, or as part of, an evaporator pressure vessel that has an internal diameter greater than six inches (152 millimeters) that is used in whole or in part as an evaporator and is insulated or installed in an insulated space, and that may be shut off by a valve from the other parts of the refrigerating system, must be protected by a pressure relief device according to this part. The requirement for a second parallel pressure relief valve does not apply.

**Subp. 7. Required capacity formula.** The minimum required discharge capacity of the pressure relief device for a pressure vessel must be determined by the following:

$$C = 0.5DL \text{ (lb/min.)} \quad C = 2.44DL \text{ (kg/min.)}$$

Where:

C = minimum required discharge capacity of the relief device in pounds of air per minute (kilograms per minute)

D = outside diameter of the vessel in feet (meters)

L = length of vessel in feet (meters)

When one pressure relief device is used to protect more than one pressure vessel, the required capacity is the sum of the capacities required for each pressure vessel.

**Subp. 8. Determining discharge capacity.** The rated discharge capacity of a pressure relief valve expressed in pounds of air per minute, must be determined according to American Society of Mechanical Engineers Boiler and Pressure Vessel Code, Section VIII, Division 1. Pipe and fittings between the pressure relief valve and the parts of the system it protects must have at least the area of the pressure relief valve inlet.

**Subp. 9. Discharge to a safe location.** Discharge of pressure relief devices on systems containing ammonia refrigerant must be to the outside of the building.

**Subp. 10. Discharge into low side.** Pressure relief valves may discharge into the low side of the system, if the pressure relief devices are of a type not significantly affected by back pressures and if the low side of the system is equipped with pressure relief devices. The relief devices on the low side of the system must have sufficient capacity to protect the pressure vessels that are relieved into the low side of the system, or to protect all pressure vessels on the low side of the system, whichever relieving capacity is the largest, as computed by the formula in subpart 7. The low side pressure relief device must be set and vented to the outside of the building according to this part.

**Subp. 11. Manifolding of relief discharges.** The size of the discharge pipe from the pressure relief device must not be less than the size of the pressure relief device outlet. The

# MINNESOTA RULES 2007

## 5230.5665 PIPEFITTERS; POWER PIPING SYSTEMS

1066

discharge from more than one relief device may be run into a common header, the area of which must not be less than the sum of the areas of the pipe connected to the common header, and as required by part 5230.5945.

Subp. 12. **Maximum discharge piping length.** The maximum length of the discharge piping permitted to be installed on the outlet of a pressure relief device must be determined as follows:

$$L = 9P_1^2 D^5 / 16C^2 \quad (L = 7 \times 10^{-11} P_1^2 D^5 / C^2)$$

Where:

C = minimum required discharge capacity in pounds of air per minute (kilograms per minute)

D = internal diameter of pipe in inches (millimeters)

L = length of discharge pipe in feet (meters)

P<sub>1</sub> = rated pressure (pounds per square inch) x 1.10 + 14.7 rated pressure (kPa gage) x (1.10 + 101)

See part 5230.5665, subpart 13, for computation derived from the preceding formula.

Subp. 13. **Maximum equivalent length discharge piping (length in feet) for pressure-relief devices at various discharge capacities.**

A. Relief valve setting at 150 pounds per square inch:

Stamped Discharge Capacity C #Air/Min.	Relief Valve Setting 150 PSIG Standard Wall Iron Pipe Size in Inches					
	1/2	3/4	1	1-1/4	1-1/2	2
5	68	276				
10	17	69	231			
15	7	31	102			
20	4	17	58	226		
25	3	11	37	145		
30	2	8	26	100	218	
40		4	14	57	122	
50		3	9	36	78	274
60		2	6	25	54	190
70			5	18	40	140
80			4	14	31	105
90			3	11	24	84
100			2	9	20	68
125				6	12	44
150				4	9	30
175				3	6	22
200				2	5	17

B. Relief valve setting at 200 pounds per square inch:

Stamped Discharge Capacity C #Air/Min.	Relief Valve Setting 200 PSIG Standard Wall Iron Pipe Size in Inches					
	1/2	3/4	1	1-1/4	1-1/2	2
5	115	470				
10	29	118	394			
15	13	52	175			
20	7	29	98			

# MINNESOTA RULES 2007

1067

## PIPEFITTERS; POWER PIPING SYSTEMS 5230.5665

25	5	19	63	248		
30	3	13	44	172		
40	2	7	25	97	210	
50		5	16	62	134	
60		3	11	43	93	
70		2	8	32	68	238
80		2	6	24	52	182
90			5	19	41	144
100			4	15	33	117
125			2	10	21	75
150				7	15	52
175				5	11	38
200				4	8	29

### C. Relief valve setting at 250 pounds per square inch:

Stamped Discharge Capacity C #Air/Min.	Relief Valve Setting 250 PSIG Standard Wall Iron Pipe Size in Inches					
	1/2	3/4	1	1-1/4	1-1/2	2
5	176					
10	44	179				
15	20	80	267			
20	11	45	150			
25	7	29	96			
30	5	20	67	263		
40	3	11	37	147		
50	2	7	24	94	204	
60		5	17	66	142	
70		4	12	48	104	
80		3	9	37	80	
90		2	7	29	63	220
100		2	6	24	51	178
125			4	15	33	114
150			3	11	23	79
175			2	8	17	58
200			2	6	13	44

### D. Relief valve setting at 300 pounds per square inch:

Stamped Discharge Capacity C #Air/Min.	Relief Valve Setting 300 PSIG Standard Wall Iron Pipe Size in Inches					
	1/2	3/4	1	1-1/4	1-1/2	2
5	248					
10	62	254				
15	28	114				
20	15	54	212			
25	10	41	136			
30	7	28	94			
40	4	16	53	208		
50	3	10	34	134		
60	2	7	24	93	200	



70	5	17	68	147	
80	4	13	52	113	
90	3	10	41	89	
100	2	8	33	72	252
125	2	5	21	46	162
150		4	15	32	112
175		3	11	24	82
200		2	8	18	63

**Statutory Authority:** *MS s 326.46*

**History:** *17 SR 438*

**5230.5675 TESTING.**

A refrigerant containing component must be tested and proved tight by the manufacturer at not less than the design pressure for which it is rated. Documentation of testing may be requested by the administrative authority.

**Statutory Authority:** *MS s 326.46*

**History:** *17 SR 438*

**5230.5680 CONSTRUCTION MATERIAL SELECTION; PIPE, VALVES, FITTINGS, ACCESSORIES.**

Subpart 1. **Suitability, standards for materials.** Materials used in the construction of the equipment must be suitable for ammonia refrigerant at the coincident temperature and pressure to that the component may be subjected. No materials may be used that will deteriorate because of the presence of ammonia refrigerant or lubricating oil, or a combination of both, or any normal contaminant such as air or water. Where external surfaces of the equipment are exposed to corrosive effects of air, water, or other media, the exposed materials must be suitable for the application.

Subp. 2. **Ferrous materials.** Cast iron, malleable iron, nodular iron, steel, cast steel, and alloyed steel may be used as governed by American Society of Mechanical Engineers Boiler and Pressure Vessel Code, section VIII, division 1.

Subp. 3. **Other metals.**

A. Cooper or zinc must not be used with ammonia.

B. Aluminum may be used in tubing, valves, and gaskets. It is the responsibility of the installer of an aluminum component to provide protection from electrolysis including dielectric isolation as needed.

C. Lead may be used for packing, gaskets, and joint compounds.

D. Tin and lead tin alloys may be used but their use is not allowed at temperatures below 14 degrees Fahrenheit (minus 10 degrees centigrade).

E. Consideration must be given to the possibility of stress corrosion cracking occurring in vessels and piping exposed to ammonia.

Subp. 4. **Nonmetallic materials.** Packings, glass, plastics, and rubber may be used if they conform to this part.

Subp. 5. **Components.** Components in direct contact with ammonia must not contain copper, brass, mercury, or alloys of these materials.

Subp. 6. **Pipe.** Pipe must be carbon steel that complies with this part, or a metallic material equal for safety and pressure and temperature rating and wall thickness. Nonmetallic pipe must not be used for ammonia service. Items A to F are the minimum standards for carbon steel pipe.

A. Diameter of pipe and minimum wall thickness of liquid lines, regardless of pressure:

(1) 1-1/2 inches and smaller, American Society for Testing and Materials schedule 80 seamless pipe;

# MINNESOTA RULES 2007

1069

## PIPEFITTERS; POWER PIPING SYSTEMS 5230.5700

(2) two inches through ten inches, American Society for Testing and Materials schedule 40 seamless pipe;

(3) 12 inches through 24 inches, standard weight seamless pipe, three-eighths inch wall thickness minimum; and

(4) exceeding 24 inches, standard weight pipe, three-eighths inch wall thickness minimum.

A liquid line through 24 inches must use American Society for Testing and Materials A-106 Grade B seamless piping.

B. Diameter of pipe and minimum wall thickness of vapor lines, regardless of pressure:

(1) ten inches and smaller, American Society for Testing and Materials schedule 40 pipe; and

(2) 12 inches and larger, standard weight pipe, three-eighths inch wall thickness minimum.

C. Threaded pipe must be American Society for Testing and Materials schedule 80 seamless minimum. Threaded fitting must be 2,000 pounds per square inch rating minimum.

D. Fittings must match pipe schedules. Threaded fittings must be forged steel. Socket weld fittings must be forged steel.

E. Carbon steel pipe must be:

(1) American Society for Testing and Materials A-53 Grade B seamless;

(2) American Society for Testing and Materials A-106 Grade B seamless; or

(3) American Society for Testing and Materials A-53 Grade B (Electrical Resistance Welded).

F. Mill test reports must be provided for the inspector at the inspector's discretion to verify heat numbers on the pipe and to verify compliance with this part.

**Statutory Authority:** *MS s 326.46*

**History:** *17 SR 438*

### 5230.5690 ULTIMATE STRENGTH REQUIREMENT.

A pressure containing component of an ammonia piping system other than pressure vessels, piping, pressure gages, and control mechanisms, must be listed either individually or as part of refrigeration equipment by an approved nationally recognized testing laboratory or must be designed, constructed, and assembled to have an ultimate strength sufficient to withstand at least three times the design pressure for which it is rated.

**Statutory Authority:** *MS s 326.46*

**History:** *17 SR 438*

### 5230.5700 BUILDING STRUCTURE AND MACHINE ROOM DESIGN.

Subpart 1. **Room layout and access.** Machinery must be located in a manner that provides at least the minimum clearances for maintenance operations called for in the equipment manufacturer's instructions, and not less than 36 inches in front of access doors for components requiring service or maintenance.

Machinery installed in or on an exterior wall of a building, that is designed so that the controls must be serviced from the outside of the building, must be accessible as provided in this part.

Subp. 2. **Roof access to ammonia equipment.** Machinery located on the roof of any building must be accessible as provided in items A and B.

A. Access must be a stairway that complies with the requirements of the Minnesota State Building Code, chapters 1301 to 1365.

B. Access must be a stair leading to a scuttle or bulkhead in the roof having the equipment. The stair leading to the scuttle or bulkhead must be placed at an angle of not more than 60 degrees measured from the horizontal with flat treads at least six inches in width and a minimum length of 24 inches at the tread. No riser may be more than nine inches and hand-

rails must be provided on both sides of the access stairs. The opening of the scuttle or bulkhead must not be less than nine square feet in area with the minimum dimension being two feet.

The required access must not be located in or pass through the elevator shaft or elevator machine room.

**Subp. 3. Roof access openings.** The roof access opening and equipment must be located with at least six feet of clearance from the edge of the roof or similar hazards, unless a suitable rail or guard at least 42 inches high is provided.

**Subp. 4. Convenience outlet.** A unit of equipment must have an accessible disconnect switch within sight line. A 20-ampere 110-120 volt AC ground-type convenience outlet must be installed on or adjacent to the unit or equipment. The outlet must have ground-fault circuit-interrupter protection and must not be connected to the equipment circuit.

**Subp. 5. Vibration elimination.** Machinery must be mounted to prevent excessive vibration from being transmitted to the building structure or to connected equipment.

**Subp. 6. Shutoff valves.** Valves must be readily accessible for operation and be clearly identified. Valves above floor level must be operated only from fixed platforms, ladders, or be chain operated. Isolating valves that stop the flow of liquid and discharge gas to the low side of the plant must be readily accessible and operable from the floor or a fixed platform.

**Subp. 7. Condensation.** Machinery or piping that may cause condensation or drips must not be located over electrical facilities.

**Subp. 8. Building structure.** The building structure housing the machine room must be designed to provide adequate strength and rigidity to safely house and support compressors, accumulators, pumps, and other related equipment.

**Subp. 9. Equipment foundation.** The compressor and other heavy equipment foundations must be designed according to manufacturer's recommendations and other parameters dictated by subsoil and structural conditions and vibrations.

**Subp. 10. Roof structure.** The roof or ceiling structure must be designed to safely support the weight of suspended piping, oil traps, and other equipment.

**Subp. 11. Hub drains.** Adequate hub drains must be provided to properly dispose of wastewater according to the Minnesota State Plumbing Code, chapter 1355. The accumulation or the running of wastewater across the floor is not permitted.

**Subp. 12. Floor drains.** Adequate floor drains in a machinery room must be provided according to the Minnesota State Plumbing Code, chapter 1355, with all floors pitched toward the drains. A slick floor surface must be avoided.

**Subp. 13. Egress.** Machinery rooms and ammonia compressor rooms must be provided with a means of egress near each end of the room. Doors must swing outward and be provided with panic-type hardware.

**Subp. 14. Means of removal.** A means must be provided to allow for removal and replacement of any heavy motors or equipment from the building.

**Subp. 15. Separate location.** A separate location, separated from production or office facilities, is required for the machinery room.

**Statutory Authority:** *MS s 326.46*

**History:** *17 SR 438*

#### 5230.5705 OPEN FLAMES.

No open flames, or apparatus that may produce an open flame, may be installed in a machinery room where ammonia is used as a refrigerant. The use of matches, cigarette lighters, leak detectors, welding equipment, or other portable spark or current producing devices are not to be considered a violation of this part except that no uses of open flames or electrical current producing devices are permitted when ammonia or oil are being charged into or discharged from the system.

**Statutory Authority:** *MS s 326.46*

**History:** *17 SR 438*

**5230.5710 VENTILATION FOR MACHINERY ROOMS.**

Subpart 1. **Scope.** Ventilation standards govern the ventilation protection of the equipment. Human occupancy standards are separate and are not covered in this part.

Subp. 2. **Ventilation to outside air.** An ammonia machinery room must be provided with means for ventilation to the outside air that complies with this part. The ventilation must consist of windows or doors opening to the outer air, of the size shown in this part or of mechanical means capable of removing the air from the room according to this part. The amount of ventilation for refrigerant removal purposes must be determined by the refrigerant content of the systems in the machinery room.

The ventilation system must provide sufficient hot weather ventilation to limit the temperature rise in the machinery room to a maximum of 20 degrees Fahrenheit (11.2 degrees centigrade) above outdoor ambient temperature. The temperature is to be measured five feet above floor level.

Subp. 3. **Required ventilation.**

A. The total required ventilation must be based on the requirements of subpart 9. One of the ventilation alternatives described in item B must be provided. Natural ventilation must be provided in all cases as required in item C.

B. One of the following mechanical ventilation alternatives must be provided.

(1) The room must be provided with a continuously operated, independent mechanical ventilation system. Failure of the mechanical ventilation system must initiate a supervised alarm so corrective action can be initiated. Ventilation requirements for air flow and duct area must be at least the minimums listed in subpart 9 for the quantity of refrigerant in the systems.

(2) The independent mechanical ventilation system must be actuated automatically by a vapor detector when the concentration of ammonia in the room exceeds 40,000 parts per million, 25 percent of lower explosive limit (LEL), and also be operable manually. The vapor detectors must also initiate a supervised alarm so corrective action can be initiated. Periodic tests of the detectors, alarms, or mechanical ventilation systems must be performed.

C. In addition to mechanical ventilation required in this part, the machinery room must also be provided with openings for natural ventilation as provided in subpart 9 for the quantity of refrigerant in the systems. Opening square footage may include windows and doorway openings. The opening area in subpart 9 must be the unobstructed, openable, free area of the windows and doors in the machinery room that open to the outside.

Subp. 4. **Air supply.** Air supply and return ducts used for machinery room ventilation must serve no other area or other purpose.

Subp. 5. **Mechanical ventilation.** Mechanical ventilation must consist of one or more power driven exhaust fans, which must be capable of removing from the refrigerating machinery room the amount of air specified in subpart 9. The inlet and outlet to the fan or fans, or air duct connection must terminate outside of the building. When air ducts are used either on the inlet or discharge side of the fan, or fans, they must have an unobstructed free area not less than specified in subpart 9. Provision must be made for the introduction of tempered make-up air to replace that being exhausted in a volume equal to that being exhausted.

Subp. 6. **Air inlets.** The relative location of air inlets and discharge must be located as not to cause short circuiting.

Subp. 7. **Air discharge.** Air discharge must be directed to provide the best dispersion, taking into account natural air flow around the building, prevailing wind, and surrounding structures.

Subp. 8. **Water wash.** If dispersion is impractical, a water wash of the exhaust air may be used if approved by the building inspector. The water spray system must employ at least ten gallons per minute of water evenly distributed per 1,000 cubic feet per minute of exhausted air (1 meter<sup>3</sup>/s water per 750 meter<sup>3</sup>/s air).

# MINNESOTA RULES 2007

## 5230.5710 PIPEFITTERS; POWER PIPING SYSTEMS

1072

### Subp. 9. Minimum air duct areas and openings.

Weight of refrigerant in system, lb. (kg)	Mechanical discharge of air, cfm. (m <sup>3</sup> /min)	Duct area sq. ft. (m <sup>2</sup> )	Open areas of windows and doors, sq. ft. (m <sup>2</sup> )
20 (9.07)	150 (4.2)	1/4 (2.3 x 10 <sup>-2</sup> )	4 (37.2 x 10 <sup>-2</sup> )
50 (22.7)	250 (7.1)	1/3 (3.1 x 10 <sup>-2</sup> )	6 (55.7 x 10 <sup>-2</sup> )
100 (45.4)	400 (11.3)	1/2 (4.6 x 10 <sup>-2</sup> )	10 (92.9 x 10 <sup>-2</sup> )
150 (68.0)	550 (15.6)	2/3 (6.2 x 10 <sup>-2</sup> )	12-1/2 (1.16)
200 (90.7)	680 (19.2)	2/3 (6.2 x 10 <sup>-2</sup> )	14 (1.30)
250 (113)	800 (22.6)	1 (9.3 x 10 <sup>-2</sup> )	15 (1.39)
300 (136)	900 (25.5)	1 (9.3 x 10 <sup>-2</sup> )	17 (1.58)
400 (181)	1,100 (31.2)	1-1/4 (11.6 x 10 <sup>-2</sup> )	20 (1.86)
500 (227)	1,275 (36.1)	1-1/4 (11.6 x 10 <sup>-2</sup> )	22 (2.04)
600 (272)	1,450 (41.1)	1-1/2 (13.9 x 10 <sup>-2</sup> )	24 (2.23)
700 (318)	1,630 (46.2)	1-1/2 (13.9 x 10 <sup>-2</sup> )	26 (2.42)
800 (363)	1,800 (51.0)	2 (18.6 x 10 <sup>-2</sup> )	28 (2.60)
900 (408)	1,950 (55.2)	2 (18.6 x 10 <sup>-2</sup> )	30 (2.79)
1,000 (454)	2,050 (58.0)	2 (18.6 x 10 <sup>-2</sup> )	31 (2.88)
1,250 (567)	2,250 (63.7)	2-1/4 (20.9 x 10 <sup>-2</sup> )	33 (3.06)
1,500 (680)	2,500 (70.8)	2-1/4 (20.9 x 10 <sup>-2</sup> )	37 (3.44)
1,750 (794)	2,700 (76.5)	2-1/4 (20.9 x 10 <sup>-2</sup> )	38 (3.53)
2,000 (907)	2,900 (82.1)	2-1/4 (20.9 x 10 <sup>-2</sup> )	40 (3.72)
2,500 (1,134)	3,300 (93.4)	2-1/2 (23.2 x 10 <sup>-2</sup> )	43 (4.00)
3,000 (1,361)	3,700 (105)	3 (27.9 x 10 <sup>-2</sup> )	48 (4.46)
4,000 (1,814)	4,600 (130)	3-3/4 (34.8 x 10 <sup>-2</sup> )	55 (5.11)
5,000 (2,268)	5,500 (156)	4-1/2 (41.8 x 10 <sup>-2</sup> )	62 (5.76)
6,000 (2,722)	6,300 (178)	5 (46.4 x 10 <sup>-2</sup> )	68 (6.32)
7,000 (3,175)	7,200 (204)	5-1/2 (51.1 x 10 <sup>-2</sup> )	74 (6.87)
8,000 (3,629)	8,000 (226)	5-3/4 (53.4 x 10 <sup>-2</sup> )	80 (7.43)
9,000 (4,082)	8,700 (246)	6-1/4 (58.1 x 10 <sup>-2</sup> )	85 (7.90)
10,000 (4,536)	9,500 (269)	6-1/2 (60.4 x 10 <sup>-2</sup> )	90 (8.36)
12,000 (5,443)	10,900 (309)	7 (65.0 x 10 <sup>-2</sup> )	100 (9.29)
14,000 (6,350)	12,200 (345)	7-1/2 (69.7 x 10 <sup>-2</sup> )	109 (10.1)
16,000 (7,258)	13,300 (377)	7-3/4 (72.0 x 10 <sup>-2</sup> )	118 (11.0)
18,000 (8,165)	14,300 (405)	8 (74.3 x 10 <sup>-2</sup> )	125 (11.6)
20,000 (9,072)	15,200 (430)	8-1/4 (76.6 x 10 <sup>-2</sup> )	130 (12.1)
25,000 (11,340)	17,000 (481)	8-3/4 (81.3 x 10 <sup>-2</sup> )	140 (13.0)
30,000 (13,608)	18,200 (515)	9 (83.6 x 10 <sup>-2</sup> )	145 (13.5)
35,000 (15,876)	19,400 (549)	9-1/4 (85.9 x 10 <sup>-2</sup> )	150 (13.9)
40,000 (18,144)	20,500 (580)	9-1/2 (88.2 x 10 <sup>-2</sup> )	155 (14.4)
45,000 (20,412)	21,500 (609)	9-3/4 (90.6 x 10 <sup>-2</sup> )	160 (14.9)

**Statutory Authority:** *MS s 326.46*

**History:** *17 SR 438*

## 5230.5820 ELECTRICAL STANDARDS FOR AMMONIA INSTALLATIONS.

**Subpart 1. Installation standards.** Electrical equipment and wiring must be approved by the electrical inspector and installed consistent with the standards of the Minnesota State Electrical Code.

**Subp. 2. Electrical material.** Heavy-wall galvanized conduit must be used in machinery rooms.

**Subp. 3. Machinery room lighting.** A machinery room must be equipped with light fixtures to provide a minimum 30 foot-candles (322.8 lumen per meter<sup>2</sup>) at the working level 36 inches above the floor or platform. Fixtures must be designed to prevent unauthorized replacement of the lights with lights of lesser voltage. Each unit of equipment must have an

# MINNESOTA RULES 2007

1073

## PIPEFITTERS; POWER PIPING SYSTEMS 5230.5915

accessible disconnect switch within sight line. A 20-ampere 110-120 volt AC ground-type convenience outlet must be installed on or adjacent to the unit or equipment in the machinery room. The outlet must have ground-fault circuit-interrupter protection and must not be connected to the equipment circuit.

**Statutory Authority:** *MS s 326.46*

**History:** *17 SR 438*

### 5230.5825 INSULATION.

Subpart 1. **Basic requirements.** Piping that operates at a temperature of less than 60 degrees Fahrenheit or more than 105 degrees Fahrenheit must be insulated with at least one inch of a suitable material having a thermal resistance of at least R4 to R4.6 per inch of thickness on a flat surface at a mean temperature of 75 degrees Fahrenheit except as provided in item A or B.

A. compressor discharge piping to the condenser does not require insulation if it is properly guarded to prevent accidental contact; or

B. control valves located inside or outside the machinery room do not require insulation if suitable means is provided for water (condensate) to be drained or disposed of safely consistent with the Minnesota State Plumbing Code, chapter 1355.

Subp. 2. **Prevention of condensation.** Suction lines, accumulators, surge drums, and similar surfaces that operate at or below the dew point temperature must be insulated to prevent the accumulation of condensation on surfaces adjacent to the piping according to the following minimum:

40 to 60 degrees = one inch of insulation

below 39 degrees = one and one-half inch of insulation

Subp. 3. **Hot piping.** Exposed hot water or hot gas discharge piping within seven feet of the floor or working platform or within 15 inches measured horizontally from stairways, ramps, or fixed ladders must be covered with an insulating material, or guarded in a manner to prevent contact with the piping.

**Statutory Authority:** *MS s 326.46*

**History:** *17 SR 438*

### 5230.5915 PIPING JOINTS.

Subpart 1. **Design standards.** Piping joints must be designed for ammonia service. Joints must be designed for the pressure temperature and mechanical strength requirements of ammonia service and items A to E.

A. One and one-quarter inch and smaller joints may be threaded or welded. Threaded pipe must be American Society for Testing and Materials schedule 80 seamless. Threaded fittings must be 2,000 pounds per square inch rating. Threaded fittings must be forged steel.

B. Joints one and one-half inch and larger must be welded. Fittings must match pipe schedule and material. Welded pipe one and one-half inch and smaller must be jointed with the use of socket weld fittings of at least 3,000 pounds per square inch ratings or butt weld fittings of the same wall thickness and material as the pipe. Socket weld fittings must be forged steel.

C. Flanges must be a tongue and groove type rated at least 300 pounds per square inch and designed for ammonia service and system pressure.

D. Gaskets must be designed for ammonia service and system pressure.

E. Unions must be at least 3,000 pounds per square inch forged steel ground joint unions, be used only for three quarters inch and smaller pipe, and must be socket weld.

Subp. 2. **Branch, run-outs, laterals, and saddles.** If the main piping is two inches and smaller, or the branch or run-out is two inches and smaller, branch or lateral connections must be forged steel TEE fitting, forged steel WELD-O-LET™ or THREAD-O-LET™, or engineering equivalent of at least 3,000 pounds per square inch rating. Engineering equivalency must be based on proper documentation signed by a registered professional engineer.

Where the main piping exceeds two inches, branch or lateral connections must be made by forged steel TEE fitting, be forged steel WELD-O-LET™, or THREAD-O-LET™ of at least 3,000 pounds per square inch rating; or in cases where the branch exceeds two inches (further providing that a branch lateral or saddle is two pipe sizes smaller than the main piping it is connected to) the connection may be made by the use of a saddle or lateral connection that complies with the requirements of this part.

Branches or runouts the same size as the main must be connected using forged steel TEE fittings.

Welding of saddles and laterals must comply with the provisions of standard B31.5 and result in proper fusion through the weld and must be subjected to nondestructive testing including radiography at the discretion of the administrative authority.

The costs of nondestructive testing for labor and materials and all testing media must be at the expense of the installing contractor.

**Subp. 3. Welding of large joints.** Two inches and larger welded joints must be butt weld fittings that are of the same schedule as the piping and in no case less than the same wall thickness and material of the pipe.

**Subp. 4. Maximum pressure service.** Pipe, fittings, and components for ammonia service must be used only for pressure service that is 90 percent or less of component design working pressure.

**Subp. 5. Components.** The assembly of the various components, whether done in a shop or as a field erection, must be done so that the completely erected piping and equipment conform with the requirements of this chapter.

**Statutory Authority:** *MS s 326.46*

**History:** *17 SR 438*

### 5230.5925 WELDING.

**Subpart 1. Certification.** Welders must be certified under a welding procedure for the job. An employer is responsible for the welding done by personnel of its organization, and must conduct any required tests and maintain necessary records of the tests.

**Subp. 2. Scope.** This part applies to the installation and repair of ammonia piping system and component parts, such as pipe, hangers, braces, and supports.

**Subp. 3. Welding qualifications.** Standard qualifications for welding procedures, welders, and welding operators made according to American Society of Mechanical Engineers Boiler and Pressure Vessel Code, section IX, qualify for work under this part.

**Subp. 4. Welding qualifications for component parts.** Standard qualifications for welding procedures, welders, and welding operators made according to American Welding Society, Structural Welding Code-Steel, standards also qualify the welder for welding component parts such as hangers, braces, and supports.

**Subp. 5. Expiration of welder certification.** Welders certifications expire after three years from the original date of certification. Welders certified by the welding procedures specification must recertify by performing the original welding test used for certification in that process.

**Subp. 6. Document submission requirements.** Welding on projects for ammonia piping systems must have welding procedure specification and procedure qualification records submitted for each project with the permit applications for approval before work begins.

**Subp. 7. Weld procedure and qualification requirements.** No welding may be performed on ammonia piping systems without welding procedures specification, and welding procedures qualification. Welding performed on ammonia piping systems must be performed using only welders properly certified according to the welding procedure submitted.

**Subp. 8. Welding requirements.** Welding of ammonia piping systems components must meet the requirements of the welding procedures specification and procedure qualification record.

**Subp. 9. Welding procedures required.** A certified welding procedure for each project must be a welding procedure specification supported by the procedure qualification

record. If the certified welding procedure is on file with the Department of Labor and Industry and no changes are necessary, a new filing is not required. At a minimum, certified welding procedures must be updated after each revision.

Subp. 10. **Evaluation standards.** The welding procedure specification and procedure qualification record must be objectively evaluated by and acceptable to the administrative authority.

Subp. 11. **Welders certification.** Welders must be certified according to the certified welding procedure for that project.

Subp. 12. **Documentation required.** Welding for ammonia piping systems must be supported by the mandatory documents of welding procedure specification, welding procedure qualification, and procedure qualification record. These documents must be available at the work site.

Subp. 13. **Weld identification.** Welds on ammonia piping must be identifiable.

Subp. 14. **Welder identification number and log requirement.** A welder certified for a project must be assigned an identification number unique to that welder. Welds must be stamped or marked. The use of a welding log is required.

Subp. 15. **Contractor responsibility.** The contractor is responsible for establishing and retaining the needed documents to conform to the requirements of this part.

Subp. 16. **Guide bend test.** When the welding processes in item A or B are indicated on the welding procedure specification, the guide bend test is required when certifying the welding procedure specification and for individual welder qualification:

- A. gas metal arc welding; or
- B. submerged arc welding.

The use of a guide bend test-jig is mandatory. The jig must be approved by the administrative authority.

A guide bend test consists of at least two coupons for each of the following: face bend, root bend, or four side bends. The use of part 5230.1080, subpart 6, shall apply provided the requirements of this part are met.

Subp. 17. **Nondestructive testing.** The administrative authority shall require the use of nondestructive testing including radiography for inspection of the welding of ammonia piping systems. Selection of nondestructive testing examination techniques shall be consistent with project design specifications, or with the requirements of standard B31.5 whichever is more restrictive. Where a weld fails examination, it will be the responsibility of the installing contractor to replace, repair, or prove the weld. The costs of nondestructive testing for labor and materials and all testing media shall be at the expense of the installing contractor.

Subp. 18. **Repair welds.** Repair welds must meet the requirements of this part. In emergency situations, work may commence immediately. However, the contractor must send a permit request to the department within one working day of commencement of the emergency work, provide the department with facsimile or telephone notice of the commencement of the emergency work within one working day of commencement of the emergency work, and request inspection of the work in conjunction with the notice of commencement of the work.

**Statutory Authority:** *MS s 326.46*

**History:** *17 SR 438*

### 5230.5930 STOP VALVES.

Subpart 1. **Location of valves.** Stop valves for stopping flow of refrigerant for service must be located at the inlet and outlet of each component of the system, including:

- A. compressor;
- B. condenser;
- C. receiver;
- D. evaporator; and
- E. vessels, pumps, and those items needed for safe and proper operation of the system.



# MINNESOTA RULES 2007

## 5230.5930 PIPEFITTERS; POWER PIPING SYSTEMS

1076

Subp. 2. **Valve design.** Manual valves must be designed for ammonia service and made of materials suitable for ammonia service and shall be angle or globe type. Valves must be capable of backseating. Quarter turn valves must not be used for ammonia service.

Subp. 3. **Number and placement of stop valves.** Sufficient stop valves must be installed to expedite service and repair and to allow isolation of ammonia components by emergency responders.

**Statutory Authority:** *MS s 326.46*

**History:** *17 SR 438*

## 5230.5935 MISCELLANEOUS MATERIALS.

Subpart 1. **Scope.** Standards for miscellaneous materials are as stated in this part.

Subp. 2. **Gauge lines.** Gauge lines for ammonia not more than one-fourth inch outside diameter or less must be constructed of materials that comply with the requirements of this chapter. These may be compressive type fittings, such as "SwageLock™," or 2,000 pounds per square inch rated engineering equivalent. Engineering equivalency must be based on proper documentation signed by a registered professional engineer.

Subp. 3. **Accessories.** Factory assembled accessories may use tubing of a larger size which must be of a material designed for ammonia service and joined by compressive type fittings, such as "SwageLock™," or engineering equivalent based on proper documentation signed by a registered professional engineer, or 2,000 pounds per square inch rated equivalent.

**Statutory Authority:** *MS s 326.46*

**History:** *17 SR 438*

## 5230.5940 PIPING HANGERS AND SUPPORTS.

Subpart 1. **Hangers and supports specifications.** The supports must carry the weight of the pipe, including contents and insulation, and, if necessary, provide sway bracing to minimize vibration.

Subp. 2. **Components.**

A. The required maximum spacing of hangers and minimum hanger rod size for steel pipe:

Nominal pipe

Maximum Size	Minimum Rod Space	Diameter
Up to 1 inch	7 feet	3/8 inch
1-1/4 to 1-1/2 inches	9 feet	3/8 inch
2 inches	10 feet	3/8 inch
3 inches	12 feet	1/2 inch
3-1/2 inches	13 feet	1/2 inch
4 inches	14 feet	5/8 inch
5 inches	16 feet	5/8 inch
6 inches	17 feet	3/4 inch
8 inches	19 feet	7/8 inch
10 inches	22 feet	7/8 inch
12 inches	23 feet	7/8 inch

B. This chart represents mandatory maximum requirements for hanger rod loading. Maximum loads are in pounds at 650 degrees Fahrenheit based on threaded hot rolled steel conforming to American Society for Testing and Materials A-107.

Rod Diameter in Inches	Max Load in pounds
3/8	610
1/2	1,130
5/8	1,810
3/4	2,710

# MINNESOTA RULES 2007

1077

## PIPEFITTERS; POWER PIPING SYSTEMS 5230.5950

7/8	3,770
1	4,960
1-1/8	6,230
1-1/4	8,000
1-1/2	11,630
1-3/4	15,700
2	20,700
2-1/4	27,200
2-1/2	33,500
2-3/4	41,600
3	50,600
3-1/4	60,500

**Statutory Authority:** *MS s 326.46*

**History:** *17 SR 438*

### 5230.5945 PRESSURE RELIEF PROTECTION.

Subpart 1. **Scope.** A refrigeration system must be protected by a pressure relief device.

Subp. 2. **Protection required.** Refrigeration systems must be protected according to the requirements of this part and part 5230.5660.

Subp. 3. **Discharge piping.** The extremity of the relief valve discharge line when relieved to atmosphere must be above the roof, and not within 25 feet (7.6 meters) of any window, ventilation intake, or personnel exit, and must be fitted with suitable rain protection or an ammonia diffuser. A drip pocket the size of the discharge pipe and at least 24 inches (610 millimeters) in length must be installed below a vertical riser in the discharge pipe, and it must be fitted with a drain plug or valve.

Subp. 4. **Relief piping and devices requirements.** Relief devices and relief piping must meet the requirements of parts 5230.5900 to 5230.5960. A shutoff valve must not be installed in the relief piping between the device and atmosphere.

Subp. 5. **Liquid pressure relief device.** A liquid pressure relief device to relieve hydrostatic pressure to another part of the system must be used on that portion of the liquid containing parts of the system that can be isolated from the system during operation or service and that may be subjected to dangerous pressures from hydrostatic expansion of the contained liquid due to temperature rise. It is the installers responsibility to provide hydrostatic relief protection.

Subp. 6. **Common atmospheric discharge piping.** When connecting relief valves of different pressure settings into a common atmospheric discharge pipe, the size and maximum equivalent length of the discharge pipe must be governed by the sum of the rated discharge capacities of all relief valves discharging into the pipe, at the lowest pressure setting of any relief valve discharging into the pipe.

**Statutory Authority:** *MS s 326.46*

**History:** *17 SR 438*

### 5230.5950 INSTALLATION REQUIREMENTS.

Subpart 1. **Foundations and supports.** Foundations and supports for condensing units or compressor units must be of substantial and noncombustible construction.

Subp. 2. **Moving machinery.** Moving machinery must be guarded according to Occupational Safety and Health safety standards.

Subp. 3. **Clearances.** Clear space adequate for inspection and servicing of condensing units or compressor units must be provided.

Subp. 4. **Enclosures.** Condensing units or compressor units with enclosures must be readily accessible for servicing and inspection.

Subp. 5. **Water supply and discharge.** Water supply and discharge connections must be made according to safety and health standards of the Minnesota State Plumbing Code,

chapter 1355, and the water pollution standards of the Minnesota Pollution Control Agency, contained in chapter 7050.

Subp. 6. **Discharge lines.** Discharge water lines must not be directly connected to the waste or sewer systems. The waste or discharge from this equipment must be through an approved air gap and trap according to safety and health standards of the Minnesota State Plumbing Code, chapter 1355.

Subp. 7. **Illumination.** Illumination adequate for inspection and servicing of condensing units or compressor units must be provided.

Subp. 8. **Minnesota State Electrical Code.** Electrical equipment and wiring must be installed according to the Minnesota State Electrical Code.

Subp. 9. **Air ducts in restricted construction.** Standards for air duct systems of air conditioning equipment for human comfort using refrigeration are not covered in this chapter. Air ducts passing through a restricted machinery room must be of vapor tight construction and must have no openings in the room.

Subp. 10. **Joints and refrigerant containing parts in air ducts.** Joints and refrigerant containing parts of a refrigeration system located in an air duct carrying conditioned air to and from an occupied space must be constructed to withstand a temperature of 700 degrees Fahrenheit (353.3 degrees centigrade) without leakage into the air stream.

Subp. 11. **Piping joints to be visible.** Refrigerant pipe joints erected on a premise must be exposed to view for visual inspection before being covered or enclosed.

**Statutory Authority:** *MS s 326.46*

**History:** *17 SR 438*

### 5230.5960 FOUNDATIONS AND EQUIPMENT.

Subpart 1. **Supports and foundations.** Supports and foundations must be adequate to prevent excessive vibration and movement of the equipment.

Subp. 2. **Manufacturer's recommendations.** The supports must conform to the manufacturer's recommendations.

**Statutory Authority:** *MS s 326.46*

**History:** *17 SR 438*

### 5230.6100 SYSTEM TESTING.

Subpart 1. **Standards.** A contracting pipefitter is responsible for system tightness and system testing to assure tightness. The contracting pipefitter is responsible for initial system operation and system testing to assure proper and safe operation.

Subp. 2. **Sequential testing.** A testing program for ammonia refrigeration systems must be designed to assure a tight system that will operate without any appreciable loss of refrigerant, a system that will be reliable with respect to the electric components, and a system that will function according to the design with respect to controls and capacities. The test requirements of subparts 3 to 5 must be done sequentially to meet the requirements of this part.

Subp. 3. **Field tests.** Upon the complete installation of an ammonia system, the system must be tested for leaks. The high side must be tested at 250 pounds per square inch gage (17.57 kilograms/cm<sup>2</sup> gage) (1724.0 kPa gage) for water cooled or evaporative cooled systems, 300 pounds per square inch gage (21.09 kilograms/cm<sup>2</sup> gage) (1034.0 kPa gage) for air cooled systems. The low side must be tested at 150 pounds per square inch gage (10.54 kilograms/cm<sup>2</sup> gage) (1034.0 kPa gage). Test duration must be a minimum of 12 hours. There is no permissible pressure loss during the time of this test. Before testing, refrigeration compressors, liquid pumps, and pressure switches must be valved off and isolated from any test pressures. Safety relief valves must be removed and openings capped or plugged. All solenoid, pressure regulating, check, or other control valves must be opened by their manual lifting stems. Other valves must be opened except those leading to the atmosphere. Valves leading to atmosphere must be capped or locked shut. The system's ammonia compressor must not be used for the pressure test.

Subp. 4. **Test medium and pressure testing.** Oxygen or any combustible gas or combustible mixture of gases must not be used within the system for testing. Carbon dioxide or halocarbon (CFC) refrigerants must not be used as a testing gas in an ammonia system. Dry nitrogen or air must be used to raise the pressure in the ammonia system to the proper level of the test. The gas must be put in the system through the charging valve or any other suitable opening using the necessary regulators and relief devices. Leaks must be repaired and defective material be replaced. After a system is thoroughly tested, the valves on the lower part of the system must be opened. The valves must be quickly opened wide.

Subp. 5. **Leak testing.** Upon completion of the pressure testing and evacuation to minimum ten inches (25.40 centimeters) mercury (Hg) vacuum, sufficient ammonia must be introduced into the system and the system subjected to 100 pounds per square inch gage (7.03 kilograms/cm<sup>2</sup> gage) (689.5 kPa gage) ammonia pressure. During this period, the system must be carefully inspected for leaks using sulphur tapers or litmus paper.

A. Two ammonia gas masks must be available during this test in a readily accessible location immediately adjacent to the testing location in case of an emergency.

B. If any leaks are found, they must be repaired and rechecked before the system can be considered tight. No repairs may be made to welded joints while the system is under pressure. The costs of testing for labor and materials and all testing media must be at the expense of the installing contractor.

Subp. 6. **Witnessed test.** Where a test is required, and an inspector is present, a declaration of test shall be signed by the inspector. The installing contractor shall provide no less than one working day advance notice of the test to the administrative authority.

**Statutory Authority:** *MS s 326.46*

**History:** *17 SR 438*

### 5230.6110 SIGNS.

Subpart 1. **Content of signs.** An ammonia piping system erected on a premises must be provided with an easily legible, readily accessible permanent metal sign that complies with subpart 2 and is securely attached to the piping. The sign must indicate the name and address of the installer, the total number of pounds (kilograms) weight of ammonia refrigerant required in the system for normal operations, and the field test pressure applied.

Subp. 2. **Equipment signs.** Metal signs for ammonia piping systems must be provided and have letters at least one-half inch (one millimeter) in height that designate:

- A. the system's main shutoff valve king valve;
- B. hot gas bypass;
- C. liquid shutoff valves;
- D. the main shutoff valves to each vessel;
- E. main steam or electrical control;
- F. equipment disconnects;
- G. remote control switches; and
- H. the pressure limiting device.

On all exposed high pressure and low pressure piping in each room where installed and adjacent to all valves must be signs, as specified in items A to H, with the name of the refrigerant and letters "HP" or "LP" and high side or low side, the piping painted in the complying colors, and arrows showing flow direction.

Subp. 3. **Pipe identification.** Pipe colored marking for the ammonia piping system must be yellow with black letters and black arrows. Signs must be yellow with black letters. Piping identification must conform with American National Standards Institute, American Society of Mechanical Engineers standard A13.1, standard for the identification of piping.

**Statutory Authority:** *MS s 326.46*

**History:** *17 SR 438*

### 5230.6115 REFRIGERANTS.

Subpart 1. **Charging and discharging refrigerants.** When refrigerant is added to a system, it must be charged into the low pressure side of the system. Any point on the down-

stream side of the main liquid line stop valve is part of the low pressure side when operating with the stop valve in the closed position. No service container may be left connected to a system except while charging or withdrawing refrigerant. Heat must not be applied to the cylinder.

Subp. 2. **Transfer to approved cylinder.** Refrigerants withdrawn from refrigerating systems must be transferred only to containers approved by a nationally recognized testing laboratory.

Subp. 3. **Care of containers.** Containers used for refrigerants withdrawn from a refrigerating system must be carefully weighed each time they are used for this purpose. The containers must not be filled in excess of the rated capacity weight for the containers and the type of refrigerant used.

Subp. 4. **Maximum storage.** Refrigerant stored in a machinery room must be not more than 300 pounds (136 kilograms) weight, in addition to the charge in the system. The refrigerant must be stored in a permanently attached receiver and only in storage containers approved by the administrative authority.

**Statutory Authority:** *MS s 326.46*

**History:** *17 SR 438*

### 5230.6120 MASKS OR HELMETS.

Subpart 1. **Location.** At least two masks or helmets must be provided at a readily accessible location immediately adjacent to each machinery room.

Subp. 2. **Approved masks.** Only complete helmets or masks suitable for ammonia must be used and they must be kept in a suitable readily accessible cabinet immediately outside the machinery room or other readily accessible location.

Subp. 3. **Canister/mask renewal.** Canisters or cartridges of helmets or masks must be renewed immediately after having been used or the seal broken and, if unused, the canisters must be renewed not later than the date noted on the canister labels.

Subp. 4. **Reference standard.** For standards for masks refer to American National Standards Institute, standard Z87.1, practice for occupational and educational eye and face protection.

**Statutory Authority:** *MS s 326.46*

**History:** *17 SR 438*

### 5230.6125 MAINTENANCE AND OPERATION.

Subpart 1. **Maintenance.** Ammonia refrigerating systems must be maintained by the user in a clean condition, free from accumulations of oily dirt, waste, and other debris, and must be kept accessible at all times.

Subp. 2. **System responsibility.** It is the responsibility of the person in charge of the premises on which an ammonia piping system containing more than 50 pounds (22.68 kilograms) weight of ammonia is installed, to conspicuously place in a readily accessible location as near as practicable to the ammonia compressor, a sign that complies with part 5230.6110 and gives clearly written directions for the operation of the system, including precautions to be observed in case of a breakdown or leak as follows:

- A. instruction for shutting down the system in case of emergency;
- B. the name, address, and day and night telephone numbers to obtain service;
- C. the name, address, and telephone number of the administrative authority, and instructions to notify the authority immediately in case of emergency;
- D. an ammonia incident action plan that includes the following minimum instructions for dealing with an ammonia leak:
  - (1) sound an alarm;
  - (2) notify fire department/emergency responders immediately;
  - (3) muster plant personnel;

- (4) isolate area;
- (5) secure supply line to leak area;
- (6) secure return line from leak area;
- (7) shut down refrigeration system or transfer refrigerant to a receiver outside of affected area;
- (8) investigate the use of proper safety equipment and proper procedures;
- (9) make sure no flames or sparks enter leak area;
- (10) provide water spray and ventilation to neutralize and reduce the concentration of ammonia;
- (11) repair leak if possible;
- (12) begin cleanup or neutralizing procedure; and
- (13) notify the proper administrative authority of the problem.

Subp. 3. **Ammonia incident action plan.** An ammonia incident action plan is a mandatory document and must be available for implementation in the event of an ammonia spill or incident. The ammonia incident action plan governs the required response to an ammonia spill or leak.

**Statutory Authority:** *MS s 326.46*

**History:** *17 SR 438*

#### **5230.6130 DECLARATION OF TEST.**

A dated declaration of test must be prepared for ammonia piping systems. The declaration must give the name of the refrigerant and the field test pressure applied to the high side and the low side of the system. The declaration of test must be signed by the licensed contractor and, if an inspector is present at the tests, the inspector must also sign the declaration. When requested, copies of the declaration must be furnished to the administrative authority.

**Statutory Authority:** *MS s 326.46*

**History:** *17 SR 438*

#### **5230.6200 AMMONIA HANDLING AND STORAGE.**

Subpart 1. **Charging lines.** The refrigeration system must be equipped with valved charging lines to allow anhydrous ammonia to be fed into either the liquid receiver, liquid line, or low side receiver line or receiver. Charging lines must comply with the liquid line requirements of part 5230.5900.

Subp. 2. **Unloading lines.** Unloading lines must be suitable for ammonia service and designed to be capable of withstanding 350 pounds per square inch gage (24.6 kilograms/cm<sup>2</sup> gage) (2413.0 kPa gage) working pressure. Pipe must conform with the liquid line requirements of part 5230.5900 and applicable portions of parts 5230.5000 to 5230.6310.

Subp. 3. **Storage tanks.** The maximum storage tank design capacity must be 50,000 gallons (189.25 meter<sup>3</sup>) of anhydrous ammonia when held at atmospheric temperatures. Tanks must meet American Society of Mechanical Engineers Boiler and Pressure Vessel Code, section VIII, division 1, construction and be designed for 250 pounds per square inch gage (17.57 kilograms/cm<sup>2</sup> gage) (1724.0 kPa gage) working pressure minimum.

Subp. 4. **Storage tank capacity.** A storage tank capacity for anhydrous ammonia must be limited to 56 percent of water weight capacity at 60 degrees Fahrenheit (15.6 degrees centigrade). Gage glasses must be equipped with excess flow valves to stop the flow of ammonia if breakage occurs. Meters with mercury as the manometer liquid must not be used.

Subp. 5. **Procedures.** The unloading of either tank truck or railroad tank car must be done by creating a pressure differential between the storage tank and the portable vessel or a direct transfer by suitable liquid ammonia pump. Flexible connections of ammonia design at 350 pounds per square inch gage (24.6 kilograms/cm<sup>2</sup> gage) (2413.0 kPa gage) working pressure rating must be used between the portable vessel and unloading rack. Cars must be blocked before connections are made and proper warning signs must be put in place on a railroad siding. The unloading operation must be under continuous supervision.

# MINNESOTA RULES 2007

## 5230.6200 PIPEFITTERS; POWER PIPING SYSTEMS

1082

Subp. 6. **Masks and helmets.** Two safety masks approved under American National Standards Institute, standard Z87.1, must be located in a readily accessible location immediately adjacent to the unloading or charging operation.

**Statutory Authority:** *MS s 326.46*

**History:** *17 SR 438*